

Sunny Boy 3300 / 3800 String Inverter with OptiCool



Explanation of Symbols used in this Document

This symbol indicates information that is essential for a trouble-free and safe operation of the product. Please read these sections carefully in order to avoid any damages of the equipment and for optimal personal protection.



This symbol indicates information that is required for the optimal operation of the product. Read these sections carefully in order to ensure an optimal operation of the product and all its features.



This symbol indicates an example.



Liability exclusion

The information contained in this documentation are the property of **SMA Technologie AG**. No part of this documentation may be published without written permission from **SMA Technologie AG**. A reproduction for internal purposes for the evaluation of the product or an appropriate application is permitted and does not require authorization.

All information are based on our "General Terms and Conditions of Delivery of **SMA Technologie AG**". The content of this documentation is reviewed continuously and adjusted, if necessary. **SMA Technologie AG** provides this documentation without exclusion of deviations and without warranty of completeness. You will find the current version on the Internet at www.SMA.de or can obtain it via the usual sales channels. Warranty or liability claims for all kinds are excluded in case of damages due to:

- Inappropriate use of the product
- Operation of the product in an improper environment
- Operation of the product without considering the relevant safety regulations
- Non-fulfillment of the warnings or safety instructions described in the documentation for the product
- Operation of the product under faulty conditions concerning security and protection
- Arbitrary changing of the product or the provided software
- Failure of the product due to interference of connected or contiguous devices out of legal limit values
- Disasters and force majeure

Software Licensing

The use of the provided software by **SMA Technologie AG** is subject to the following conditions: The software may be reproduced for internal purposes and installed on any number of computers. Provided source codes can be changed and adjusted on the company's own authority according to the internal purpose. Driver may be ported to other operating systems as well. No part of the source codes may be published without written permission of **SMA Technologie AG**. Sublicensing of the software is not acceptable.

Liability limitation: **SMA Technologie AG** disclaims liability for any direct or indirect consequential damages arising from the use of the software produced by **SMA Technologie AG**. The same applies for the provision and/or non-provision of support.

Provided software not produced by **SMA Technologie AG** is subject to the respective licensing and liability agreements of the manufacturer.

Trademarks

All brand and product names used herein are trademarks or registered trademarks of their respective holders, although they may not be specifically designated as such.

SMA Technologie AG

Hannoversche Strasse 1-5

34266 Niestetal

Germany

Tel. (+49) 5 61 95 22 – 0

Fax (+49) 5 61 95 22 – 100

www.SMA.de

E-Mail: info@SMA.de

© 2005 **SMA Technologie AG**. All rights reserved.

Table of Contents

1	Foreword	7
2	Safety Instructions	9
3	Overview	11
3.1	Unit description	11
3.2	External dimensions	12
3.3	OptiCool Temperature Management	13
4	Installation requirements	15
4.1	Installation site requirements	15
4.2	PV generator requirements	17
4.3	Low voltage grid 230 V (AC)	17
5	Installation	21
5.1	Mounting the unit	21
5.2	Electrical installation	22
5.3	Startup	28
6	Opening and closing the Sunny Boy	31
6.1	Opening the Sunny Boy	31
6.2	Closing the Sunny Boy	31
7	Technical data	33
7.1	Sunny Boy 3300	33
7.1.1	PV generator connection data	33
7.1.2	Grid connection data	33
7.2	Sunny Boy 3800	34
7.2.1	PV generator connection data	34
7.2.2	Grid connection data	34
7.3	Description of the devices	35
7.4	Sunny Boy 3300 / 3800 Operating parameters	37
8	Checking heat dissipation	39
8.1	Cleaning the fan	39
8.2	Checking the fan	40
8.3	Cleaning the fan gills	41
9	Replacing the varistors	43
10	Rating for a line circuit breaker	47
11	The communications interface	51
11.1	Connection of the communications interface	52
11.1.1	Jumper functions	53
12	Contact	55

1 Foreword

The Sunny Boy may only be installed by trained specialists. Installers must be approved by the local energy supplier. Please read this 'installation manual' carefully. Please follow all applicable safety regulations, the technical connection requirements of the local energy supplier and all instructions in this installation guide.



The Sunny Boy 3300 / 3800 is equipped with the SMA grid guard. This is a type of independent disconnection device. It ensures that the Sunny Boy 3300 / 3800 complies with the VDEW (Verband der Elektrizitätswirtschaft – German Electricity Industry Association) regulations for the connection and parallel operation of electrical power units to the low-voltage grid of the electricity supply company and with DIN VDE 0126, which forms a part of these regulations.



This installation manual is intended solely for qualified electricians. Its aim is to help install and set up SMA Sunny Boy 3300 / 3800 inverters quickly and correctly.

For detailed information on troubleshooting and on how to use the Sunny Boy and the various communications options, please see the operating instructions.

"Sunny Design" helps you design the system and check string size taking the relevant inverter into consideration. Further information on Sunny Design is available at www.SMA.de.

If you require further information, please call the Sunny Boy hotline on the following number:

+49 561 95 22 - 499

2 Safety Instructions

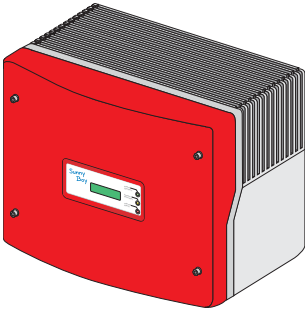

Check the system configuration using the 'Sunny Design' system design tool (www.SMA.de) or by calling the Sunny Boy Hotline (Tel. +49 (0) 561 95 22 - 499). Overvoltages can damage the Sunny Boy 3300 / 3800 and cause deflagration, which can be extremely dangerous.



Work on the Sunny Boy with the cover removed must be carried out by a qualified electrician. High contact voltages are present in the device. Before working on the Sunny Boy with the cover removed, the AC and DC voltages **MUST** be disconnected from the Sunny Boy and the capacitors must be discharged.



The Sunny Boy must be disconnected from the mains grid and precautions must be taken to prevent the grid being reconnected. In addition, the connections to the PV generator must be disconnected.

After isolating the AC and DC voltage, you must wait approx. 30 minutes for the capacitors in the Sunny Boy to discharge. Only then is it safe to open the unit by removing the cover. You must also make sure that no voltage is present in the device.

The electronics inside your Sunny Boy 3300 / 3800 is vulnerable in terms of electrostatic discharge. Be sure to be connected to ground (e.g. the enclosure of the Sunny Boy) before handling anything within the enclosure of the Sunny Boy.



3 Overview

3.1 Unit description

The following diagram gives a schematic overview of the various components and connection points inside the Sunny Boy 3300 / 3800 with the cover removed:

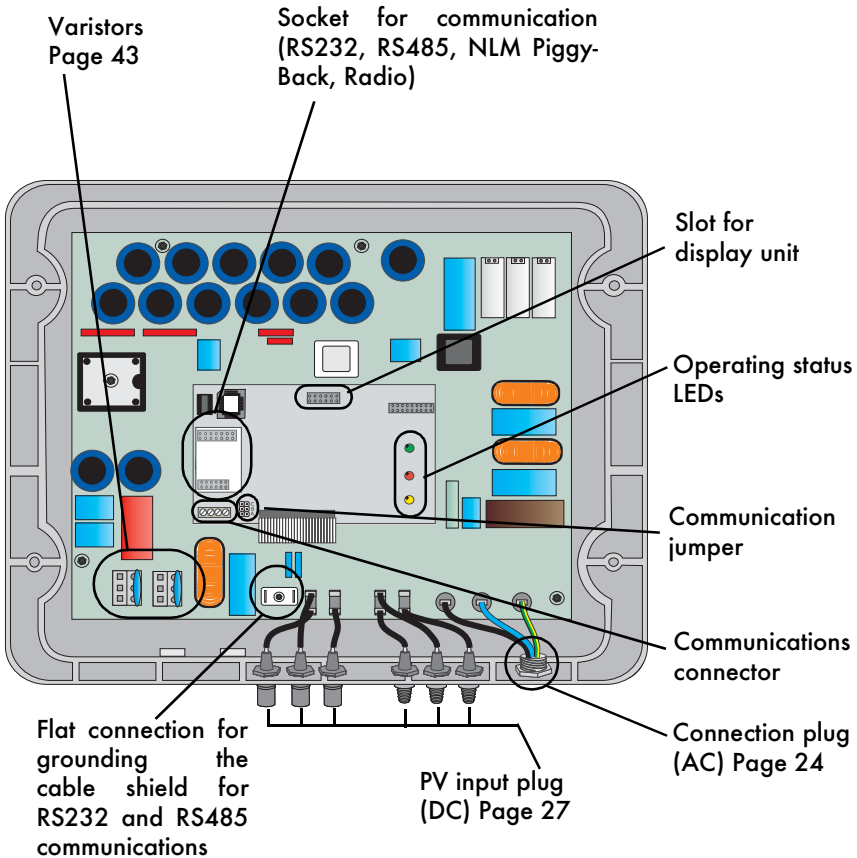

3.2 External dimensions

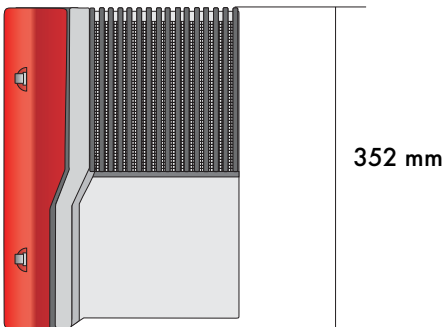
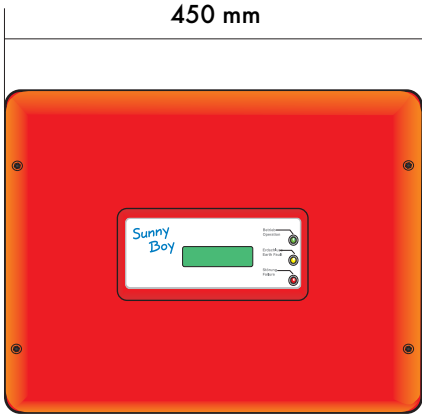
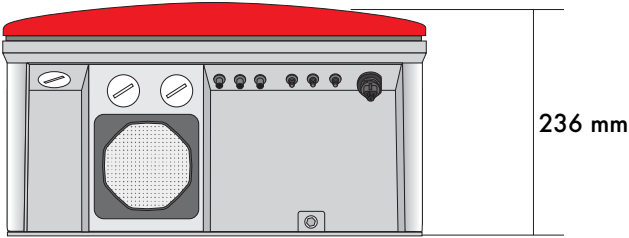

3.3 OptiCool Temperature Management

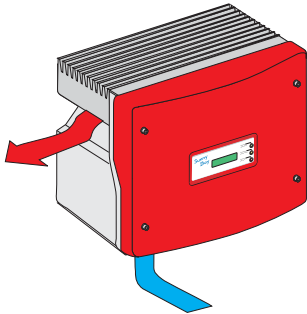

With the patented dual compartment cooling system OptiCool, SMA now offers a technical solution combining both passive and active cooling systems. An "intelligent temperature management" is the result.

In order to achieve maximum efficiency the whole enclosure of the inverter becomes part of the cooling system. It does not only contain and protect the components but also functions as a "cooling air distributor" and heat distributor.

The actual heat sink, as central component of the passive heat dissipation, is positioned within the enclosure in such a way as to divide it into two compartments. The highly sensitive electronics separated from the main heat sources by the heat sink is securely protected from external influences, such as moisture and dirt, in the front waterproof compartment.

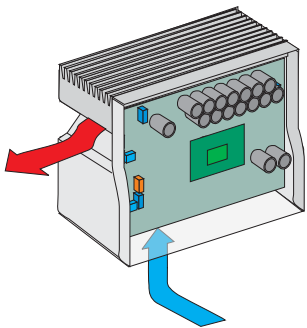

The front chamber containing the electronic components is especially sealed and thus protected against infiltration by water, dust or dirt. In addition, the heat sink, functioning as a partition wall, provides enough space for the installation of the heat-producing components.

In the rear part, the temperature-intensive components, such as chokes and transformers, which are either separately sealed or are intensive to ambient influences, are installed.

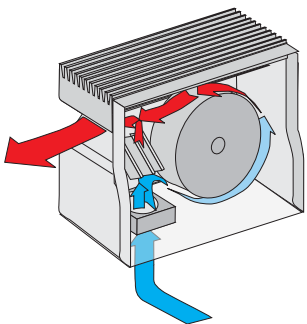

A specifically designed active cooling system is positioned on the bottom of the rear compartment. Depending on the temperature of the power semiconductors and the inductive components it is automatically activated and adjusts its speed according to the requirements of a balanced heat dissipation within the device.

The air stream produced by the fans is effectively canalized through a stream tunnel. It dissipates the waste heat of the heat sink as well as the components installed in this part.

Using OptiCool reduces the components' temperature in the entire inverter resulting in high reliability and excellent overload performance. The efficiency of the inverter and thus of the entire PV plant can therefore be increased.

Using a dual compartment system with a waterproof area for the electronics makes the inverter suitable for inside as well as outside installation (near the PV generator).

4 Installation requirements

Please check that all of the conditions listed below are met before installing and setting up the Sunny Boy.

4.1 Installation site requirements

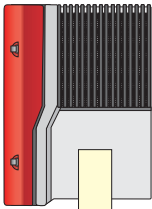

41 kg

The Sunny Boy 3300 / 3800 weighs more than 41 kg. Please take this weight into account when choosing the installation site and method of installation.

The ambient temperature must be within $-25\text{ }^{\circ}\text{C}$ to $+60\text{ }^{\circ}\text{C}$.



The Sunny Boy 3300 / 3800 should be installed in a place where it is not exposed to direct sunlight. An increased ambient temperature can reduce the yield of the PV system.

The Sunny Boy is designed to be mounted on a vertical wall. If absolutely necessary, however, the Sunny Boy can be installed tilted back at a maximum angle of 45° . For an optimum energy yield and the most convenient operation, vertical installation at eye-level is preferable. If installing the unit outdoors, make sure that it is not slanting forward. The rear panel is designed such that the Sunny Boy 3300 / 3800 is tilting slightly backward on a perfectly vertical wall.

We advise against installing the unit in a horizontal position outdoors.

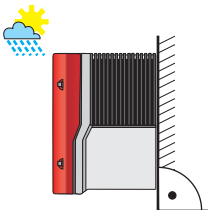

Mount the Sunny Boy in a vertical position or with a slight angle to the back.

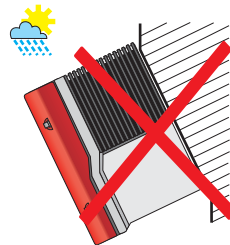
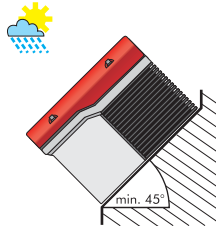

Do not mount the Sunny Boy with an angle to the front or on the back.



When choosing the installation site, be sure to note the following:



Unintentionally removal of the DC plug connector under load can damage the plug and result in injury or death! Install the Sunny Boy in such a way that it is not possible (e.g. for children) to unplug the DC plug connector unintentionally.



The temperature of some components, especially the coils, can exceed 60 °C. There is a risk of burning when touching these components!



Do not install the Sunny Boy on flammable construction materials, in areas where highly inflammable materials are stored or in potentially explosive environments!

When choosing the installation site, ensure there is enough space for heat to dissipate. Under normal conditions, the following guidelines should be applied for the space to be kept clear around the Sunny Boy 3300 / 3800:

	Minimum clearance
Sides	20 cm
Top	20 cm
Underneath	20 cm
Front	5 cm

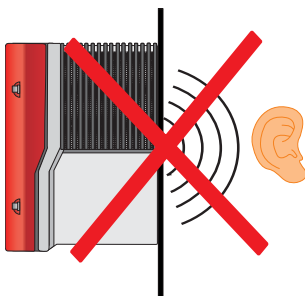
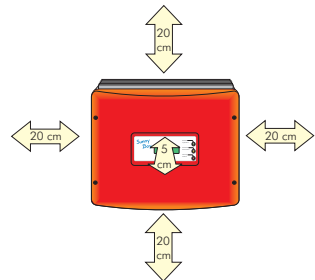

In domestic installations, the unit should not be mounted on plasterboard walls or similar as otherwise audible vibrations are likely to result.

We recommend mounting the Sunny Boy to a solid surface.

The Sunny Boy can emit noises in normal operation, which can be annoying when the Sunny Boy is installed in living areas.

4.2 PV generator requirements

The Sunny Boy 3300 / 3800 is designed to be connected to up to three strings (PV modules wired in series) having a homogenous structure (modules of the same type, identical orientation, tilt and number).

"Sunny Design" will help you both during system design and in checking the string size with regard to the inverter in question. Further information on "Sunny Design" is available at www.SMA.de.

The unit has six DC plug connectors (two for each string) for connecting the PV generators. The connecting cables from the PV generators must also be fitted with this type of plug connector. A pre-assembled set for connecting the free cable ends from a string is available as an optional accessory. The SMA order codes for the various connectors are as follows:

- Multi-contact 3mm: "SWR-MC"
- Multi-contact 4mm: "MC-SET"
- Tyco: "TYCO-SET"

Limit values for DC input	Sunny Boy 3300	Sunny Boy 3800
Max. open-circuit voltage	500 V (DC)	500 V (DC)
Max. input current	20 A (DC)	20 A (DC)

The input current of a single plug connector may not exceed 16A!



4.3 Low voltage grid 230 V (AC)

The Sunny Boy must have a three-conductor connection to the mains grid (live (L), neutral (N), protective earth (PE)).

The grid connection terminals on the AC connection socket included in the accessories kit can take wires with a cross-section of up to 4 mm². The AC connection socket accessories kit contains two sealing rings for differing cable diameter. The threaded sleeve comes from the factory already equipped with a sealing ring for cable diameters from 10 to 14 mm. If you want to install cable with a diameter between 6 and 10 mm, you will have to exchange the sealing ring against the one included in the accessories kit. For detailed instructions, see section "Connecting the AC plug" (page 25).

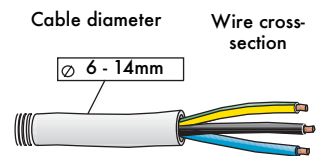



Depending on the cable cross-section being applied, please use a 20, or maximum 25A, B-type circuit-breaker. No loads should be connected to this power circuit.

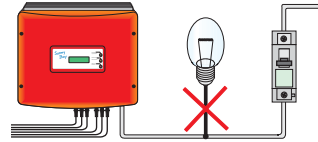

Rating for a line circuit breaker in a photovoltaic electrical power unit operated in parallel with the low-voltage grid

Various factors should be taken into account when selecting line circuit breakers. These include, for example:

- The type of cable used (conductor material and insulation)
- Ambient temperatures affect the cables (higher temperatures result in a reduced maximum current load)
- Method of routing the cable (reduces the ampacity of the conductor)
- Bundling cables together (reduces the ampacity of the conductor)
- Loop impedance [Z] (in the event of a body contact this limits the current that can flow and therefore determines the response behavior of the circuit breaker)
- Sufficient distance between the circuit breakers so as to avoid undue heating (heat can trigger the circuit breakers early).
- Selectivity
- protection class of the connected consumer (VDE 0100 Part 410 "Protection against electric shock"¹ and/or the international standard IEC 60364-4-41:1992)



Please refer to section 10 "Rating for a line circuit breaker" (page 47).



The following standards have to be complied with:

- DIN VDE 0298-4¹ ("Types of cable installation and conducting capacity")
- DIN VDE 0100 Part 430¹ ("Protection measures for protection of cables and conductors in terms of overcurrent") and/or the international standard IEC 364-4-43:1977 and IEC 364-4-473:1977
- VDE 0100 Part 410¹ ("Protection against electric shock") and/or the international standard IEC 60364-4-41:1992

-
1. The standards mentioned above are to be only used as a guideline for your installation. They apply for installations in Germany. Please note that other standards will apply for different countries throughout the world.

AC cable system impedance should not exceed 1 ohm. This is necessary, amongst other things, for the correct operation of impedance monitoring. In addition, we recommend dimensioning the conductor cross-section so that line losses do not exceed 1 % at the nominal power. Line losses depending on the cable length and cross-section are shown in the graphs below. Multi-wire cables with copper forward and return conductors are used.

Line losses of the Sunny Boy 3300

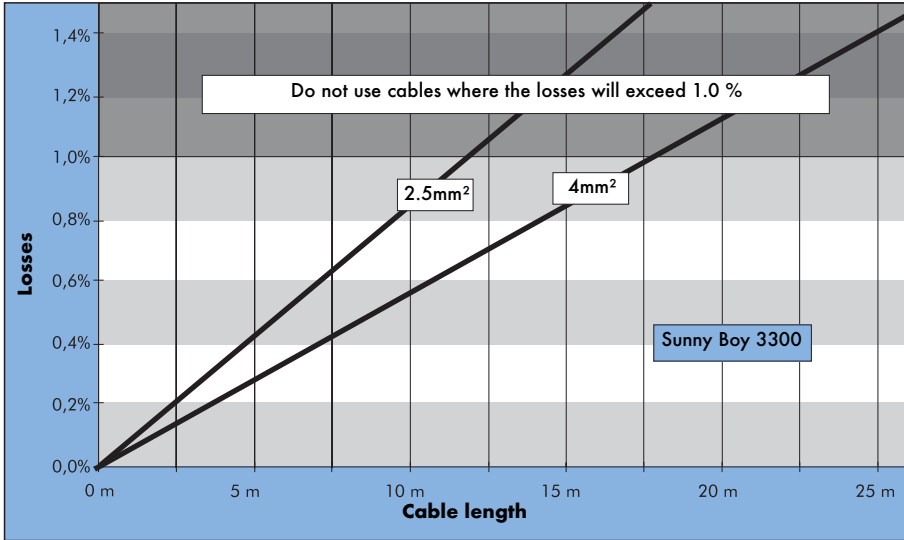

The maximum cable lengths for the different cable cross-sections are as follows:

Cable cross-section	2.5 mm ²	4 mm ²
Max. length	11.5 m	18 m

Line losses of the Sunny Boy 3800

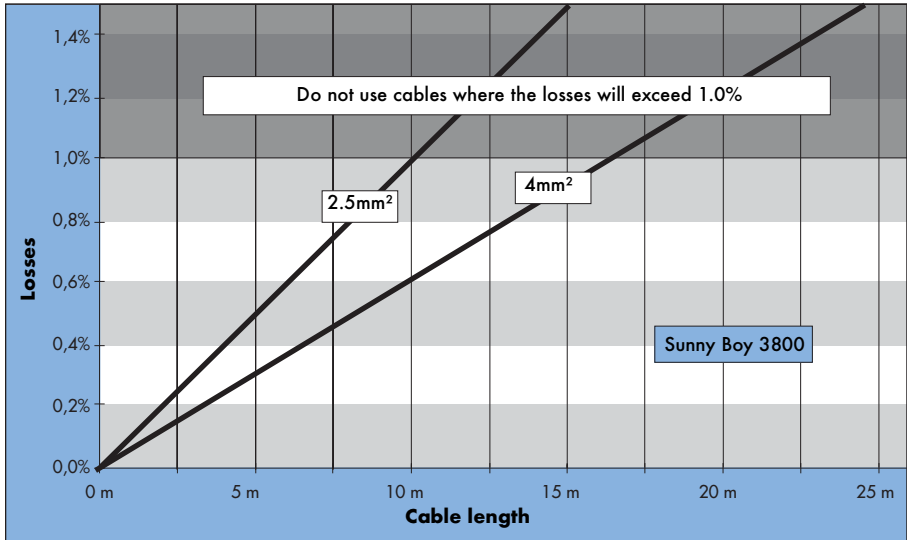

The maximum cable lengths for the different cable cross-sections are as follows:

Cable cross-section	2.5 mm ²	4 mm ²
Max. length	10 m	16 m

The Sunny Boy 3300 / 3800 is designed for operation on 230 V grids and works at grid voltages of 198 V to 260 V at 49.8 Hz to 50.2 Hz / 59.8 Hz to 60.2 Hz.

	Limit values for AC output
Voltage range	198 V ... 260 V
Frequency range 50 Hz	49.8 Hz ... 50.2 Hz
Frequency range 60 Hz	59.8 Hz ... 60.2 Hz
Voltage range (without "SMA grid guard" independent disconnection device)	180 V ... 265 V
Frequency range (with "SMA grid guard" independent disconnection device deactivated)	45.5 Hz ... 54.5 Hz 55.5 Hz ... 64.5 Hz

The Sunny Boy 3300 / 3800 is fitted with an automatic grid frequency detection. Therefore, they can be connected to a 50 or 60 Hz system without further parameterization. Always follow the grid operator's instructions.

5 Installation

5.1 Mounting the unit

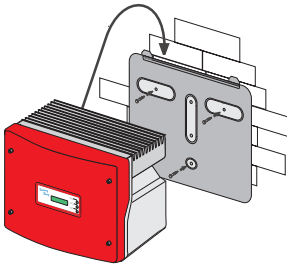

Only use the original wall mounting plate for installation. For vertical installation and solid concrete or block walls, for example, you can fit the plate using stainless steel type 8 x 50 mm hexagon bolts to DIN 571 standard and SX10-type wall anchors.

When selecting the mounting materials, be sure to take into account the weight of the Sunny Boy 3300 / 3800 (41 kg). The Sunny Boy 3300 / 3800 is equipped with ergonomic handles.

1. Remove the transport clamp and fit the wall mounting plate (1). To mark the positions to drill the holes, you can use the wall mounting plate as a drilling template.
2. Fill in the holes in the wall mounting plate which are not necessary for installation using the sealing plugs provided in the accessories kit. The sealing plugs must be entered in the wall mounting plate from behind, i.e. the side that will face the wall.
3. Now fit the Sunny Boy 3300 / 3800 by inserting its upper mounting slot into the wall bracket (2).
4. Secure the Sunny Boy 3300 / 3800 onto its bracket by screwing the supplied M6x16 bolt to the underside of the enclosure (3). You must use the washer supplied for the enclosure.
5. Make sure the Sunny Boy 3300 / 3800 is positioned securely on the bracket.
6. Close the handles with the fan gills provided in the accessories kit.

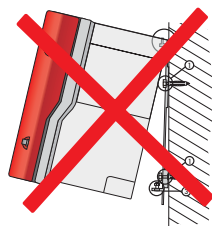
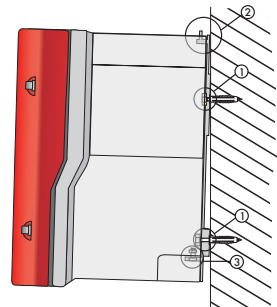

If you remove the Sunny Boy 3300 / 3800 from its wall mounting plate, make sure you keep it in a vertical position. Make sure not to tilt the Sunny Boy 3300 / 3800 up!



5.2 Electrical installation



Make sure to check polarity before connecting the strings!

The complete wiring for a Sunny Boy 3300 / 3800 is shown schematically in the following diagram:

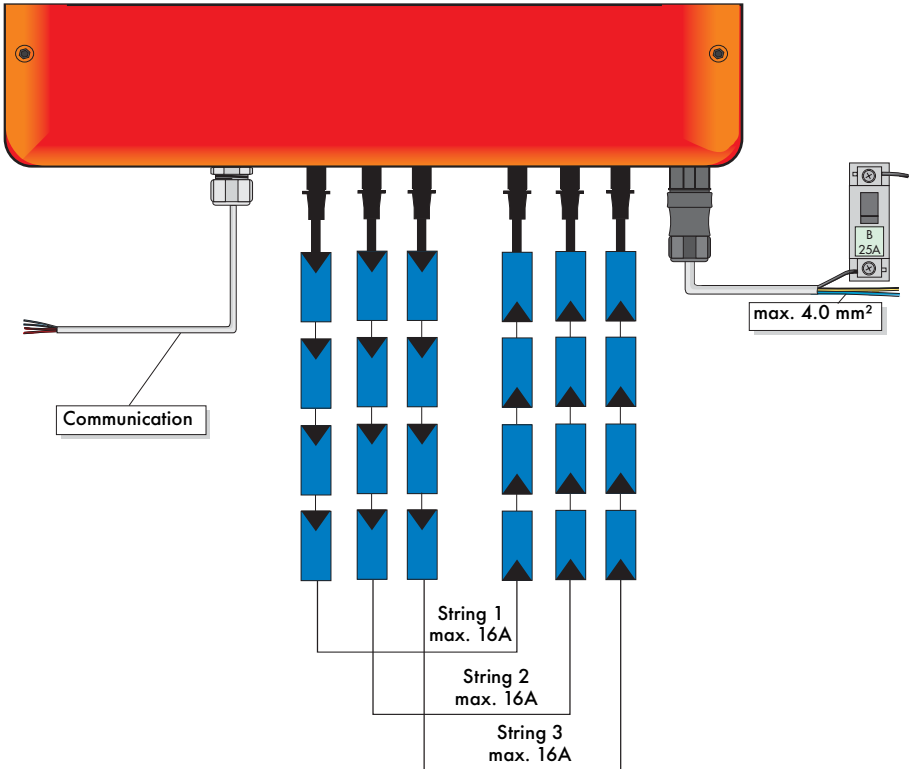

Sunny Boy 3300 / 3800 View from below

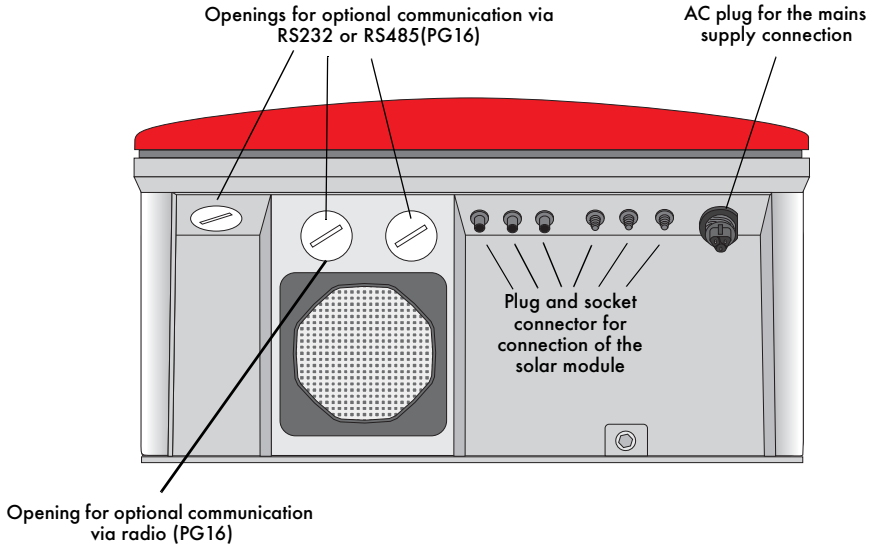

Connecting the AC output

Before you connect the mains cable to the AC connection socket, make sure that no voltage is present at the cable.



A round plug connector system is used, which allows various cable cross-sections to be used in the cable outlet.

To connect up the AC output, follow these steps:

1. Check the grid voltage. If this is higher than 260 V, the Sunny Boy 3300 / 3800 will not be fully operational. In this case, contact the local grid operator for assistance.



Max. 260 V!

The maximum grid voltage for feeding electricity into the grid is 260 V!

2. Isolate the grid connection (switch the line circuit breaker to its "off" position), make sure it cannot be switched back on, and test to make sure no voltage is present.

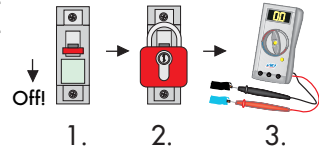

You must make sure that no voltage is present at the AC output before working on the Sunny Boy!

3. Now take the AC connection socket parts from the accessories kit and connect up the cable, with shielding and insulation stripped, as described on the following pages:

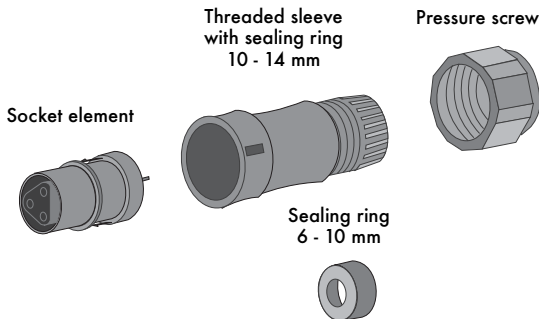

Connecting the AC plug

1. Check which sealing ring is appropriate for your AC connection cable. A sealing ring for a cable diameter of 10 - 14 mm is installed in the threaded sleeve at the factory. If you want to use a cable with a lower diameter (i.e. from 6 - 10 mm), you will have to replace the sealing ring in the threaded sleeve with the sealing ring included in the accessories kit.
2. Push or pull the sealing ring designed for a larger cable diameter off the threaded sleeve and then replace it with the sealing ring designed for lower diameters.
3. Once this is done, slide the pressure screw over the AC connection cable. Then slide the threaded sleeve with the suitable sealing ring over the cable.

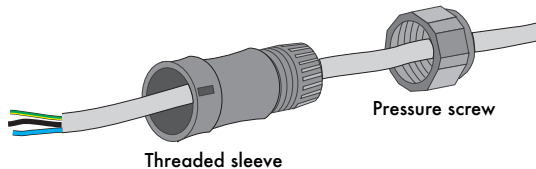

4. Now connect the individual conductors to the socket element in sequence.

- Protective earth PE (green/yellow) to the screw terminal with the earth sign. Make sure that the PE earth wire is longer than the N and L connected wires.
- Neutral conductor N (blue) to screw terminal N.
- Live L (brown or black) to screw terminal L.

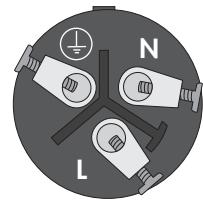

5. Make sure the wires are securely connected.

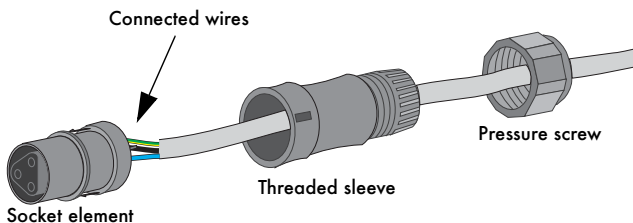

6. Press the threaded sleeve into the socket element until it audibly clicks.

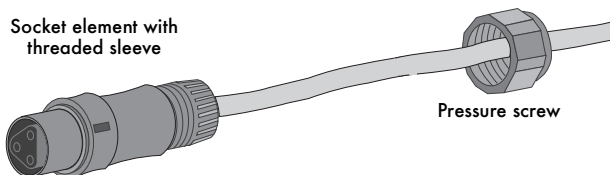

7. Now screw the pressure screw into the threaded sleeve and tighten it.
8. Firmly tighten the screw fitting against the seal and strain relief.

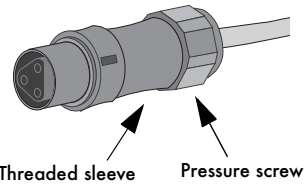

The AC connecting socket is now fully assembled.

If you are not going to connect up the Sunny Boy immediately, close off the socket element using the cap supplied in the accessories kit.

If the Sunny Boy is already installed, you can now connect up the fully assembled AC connection socket to the flange plug on the Sunny Boy. To do this, remove the protective cap from the flange plug on the Sunny Boy. Press the AC connection socket firmly against the flange plug until it audibly clicks in order both to seal and secure the connection. Observe the correct alignment for the AC connection socket.

Do not switch the line circuit breaker on yet! The Sunny Boy 3300 / 3800 may only be connected to the AC grid once the PV strings are connected and the device is securely closed.



PV string (DC) connection

To connect up the input, follow these steps:

1. Check that the PV generator connectors have the right polarity and do not exceed the maximum string voltage of 500 V (DC). See also section 4.2 "PV generator requirements" (page 17).

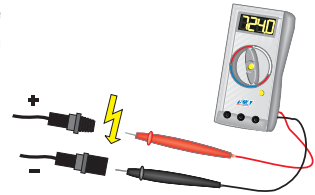

The maximum current for the single DC connector plug is 16 A.



Caution! Dangerous high voltages may be present. Danger of death!



2. Taking one DC plug connector at a time, measure the direct current voltage between one DC plug connector of a string and earth potential.
3. If the measured voltages are constant and if their total is roughly the same as the open circuit voltage of the string, then there is a ground contact in this string. Its approximate location can be deduced from the relationships between the voltages.

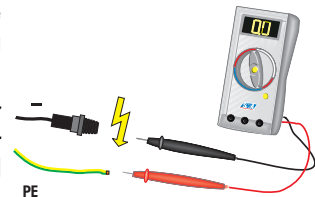

Do not connect strings to the Sunny Boy 3300 / 3800 that have a ground contact until you have removed the ground contact in the PV generator.



4. Repeat points 2 and 3 for each string.
5. Connect up the faultless PV generator strings to the inverter.
6. Close the unnecessary DC input sockets with the caps included in the delivery.

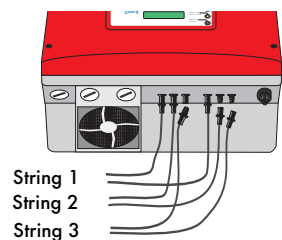

5.3 Startup

You can start up the Sunny Boy 3300 / 3800 when

- The lid is securely screwed shut.
- The AC (mains) cable is connected correctly.
- The DC cables (PV strings) are fully connected and the unused DC plug connectors on the bottom of the enclosure are closed using the protective caps.

How to start up the inverter

1. First of all, switch the line circuit breaker to the "on" position.

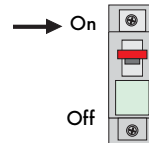

2. Now look at the LED display and consult the table on the following page to check whether the Sunny Boy 3300 / 3800 is in a fault-free operating status. Once the inverter is in a fault-free operating status, startup has successfully completed.

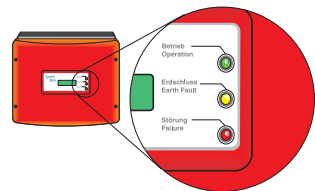

If the bottom yellow LED flashes four times at intervals of one second, the grid voltage and the PV generator must be disconnected from the Sunny Boy 3300 / 3800 immediately! There is a risk of damage to the inverter resulting from excessive DC input voltage.



Check the string voltages again to make sure they are within the limits stated in section 4.2 "PV generator requirements" (page 17). If the string voltages are too high, the PV generator's planner/installer should be called upon for assistance.

If despite checking the string voltages the LED signal occurs again when the PV generator is connected to the Sunny Boy 3300 / 3800, disconnect the PV generator from the Sunny Boy again and contact **SMA** Technologie AG (see section 12 "Contact" (page 55)).

Green	Red	Yellow	Status
Glow continuously	off	off	OK (working mode)
	Glow continuously	off	Warning
		Glow continuously	OK (initialization)
Flashes quickly (3x per second)	off	off	OK (stop)
	Glow continuously	off	Warning
Flashes slowly (1x per second)	off	off	OK (waiting, grid monitoring)
	Glow continuously	off	Warning
Briefly goes out (approx. 1x per second)	off	off	OK (derating), see section 8 "Checking heat dissipation" (page 39))
	Glow continuously	off	Warning
Is not illuminated	off	off	OK (night shutdown)
		Glow/flashing	Fault
	Glow continuously	off	Fault
Glow/flashing		Fault	

For a detailed description of the fault messages and their causes, see the operating instructions.

6 Opening and closing the Sunny Boy

If you need to open the device for whatever reason, please pay attention to section 2 "Safety Instructions" (page 9).



6.1 Opening the Sunny Boy

Caution: Follow the sequence below under all circumstances.



1. Switch the line circuit breaker to the "off" position.
2. Disconnect the PV generator from the Sunny Boy 3300 / 3800.
- 3. Wait 30 minutes!**
4. Remove the four screws from the lid and pull the cover forward smoothly. Put the cover, the screws and the washers to one side so that they do not get lost.

6.2 Closing the Sunny Boy

Caution: Follow the sequence below under all circumstances.



1. Now secure the lid to the Sunny Boy 3300 / 3800 by tightening the four screws evenly. The screws must be tightened with approximately 9 Nm torque in order to guarantee both the sealing of the enclosure and the grounding of the cover. Do not forget to reattach the washers with the indentations facing toward the lid. If you should lose a screw or washer, the Sunny Boy 3300 / 3800 accessories kit contains a spare screw and spare washer.
2. Connect the PV generator.
3. Switch the line circuit breaker to the "on" position.
4. Now check whether the LED display on the Sunny Boy 3300 / 3800 indicates that the device is functioning correctly.

7 Technical data

7.1 Sunny Boy 3300

7.1.1 PV generator connection data

Max. input open circuit voltage	U_{PV0}	500 V (based on -10°C cell temperature)
Input voltage, MPP range	U_{PV}	174 V ... 500 V @ U_{ACmin}
Max. input current	I_{PVmax}	20 A
Max. input power	P_{DC}	3800 W
Recommended total generator power		4300 W _p (in central Europe)
All-pole isolator on the DC input side		DC plug connector
Overvoltage protection		Thermally monitored varistors
Voltage ripple	U_{pp}	< 10 % of the input voltage
Insulation protection		Ground fault monitoring (Riso > 1 M Ω)
Operating consumption		< 7W (standby)
Reverse polarity protection		Short circuit diode

7.1.2 Grid connection data

Nominal output power	P_{ACnom}	3300 W
Peak output power	P_{ACmax}	3600 W
Nominal output current	I_{ACnom}	14.5 A
Harmonic distortion of output current (at $K_{Ugrid} < 2\%$, $P_{AC} > 0.5 P_{ACnom}$)	THD_{IAC}	< 3 %
Short-circuit proof		Grid-side via current regulation
Operating range, grid voltage	U_{AC}	198 ... 260 V AC
Operating range, grid frequency	f_{AC}	49,8 ... 50.2 Hz / 59.8 ... 60.2 Hz
All-pole isolation on grid side		Independent disconnection device (SMA grid guard), redundant design
Phase shift angle (based on the current's fundamental frequency)	cos Phi	1 at P_{ACnom}
Overvoltage category		III
Test voltage (50 Hz)		1.4 kV (1 s routine testing / 5 s type testing)
Test surge voltage		4 kV (serial interface: 6kV)
Internal consumption in night mode		0.1 W

7.2 Sunny Boy 3800

7.2.1 PV generator connection data

Max. input open circuit voltage	U_{PV0}	500 V (based on -10°C cell temperature)
Input voltage, MPP range	U_{PV}	174 V ... 500 V @ U_{ACmin}
Max. input current	I_{PVmax}	20 A
Max. input power	P_{DC}	4040 W
Recommended total generator power		4500 Wp (in central Europe)
All-pole isolator on the DC input side		DC plug connector
Overvoltage protection		Thermally monitored varistors
Voltage ripple	U_{pp}	< 10 % of the input voltage
Insulation protection		Ground fault monitoring ($R_{iso} > 1\text{ M}\Omega$)
Operating consumption		< 7 W (standby)
Reverse polarity protection		Short circuit diode

7.2.2 Grid connection data

Nominal output power	P_{ACnom}	3800 W
Peak output power	P_{ACmax}	3800 W
Nominal output current	I_{ACnom}	16.5 A
Harmonic distortion of output current (at $K_{Ugrid} < 2\%$, $P_{AC} > 0.5 P_{ACnom}$)	THD_{IAC}	< 3 %
Short-circuit proof		Grid-side via current regulation
Operating range, grid voltage	U_{AC}	198 ... 260 V AC
Operating range, grid frequency	f_{AC}	49,8 ... 50.2 Hz / 59.8 ... 60.2 Hz
All-pole isolation on grid side		Independent disconnection device (SMA grid guard), redundant design
Phase shift angle (based on the current's fundamental frequency)	$\cos\Phi$	1 at P_{ACnom}
Overvoltage category		III
Test voltage (50 Hz)		1.4 kV (1 s routine testing / 5 s type testing)
Test surge voltage		4 kV (serial interface: 6kV)
Internal consumption in night mode		0.1 W

7.3 Description of the devices

For a detailed description of the devices, see the operating instructions.

General data

Protection category per DIN EN 60529	IP65
Dimensions (w x h x d)	450 mm x 352 mm x 236 mm (approx.)
Weight	Approx. 41 kg

External interfaces

Data transmission over mains power line	Optional
Data transmission over separate data cable	Optional, RS232 / RS485, electrically separated
Wireless data transmission	Optional

Efficiency of the Sunny Boy 3300

Max. efficiency	η_{\max}	95.2 %
European standard efficiency	η_{euro}	94.4 %

The efficiency of the Sunny Boy 3300 depends mainly on the input voltage of the connected PV strings. The lower the input voltage, the higher the efficiency.

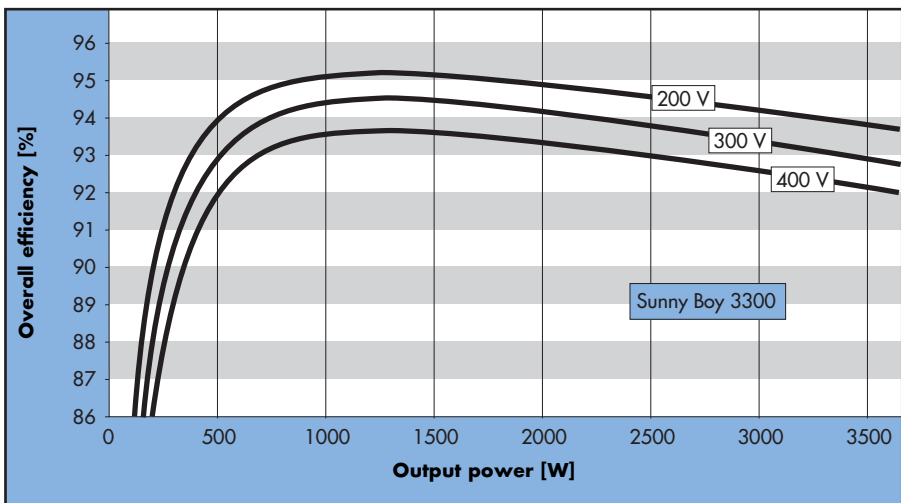

Efficiency of the Sunny Boy 3800

Max. efficiency	η_{\max}	95.6 %
European standard efficiency	η_{euro}	94.7 %

The efficiency of the Sunny Boy 3800 depends mainly on the input voltage of the connected PV strings. The lower the input voltage, the higher the efficiency.

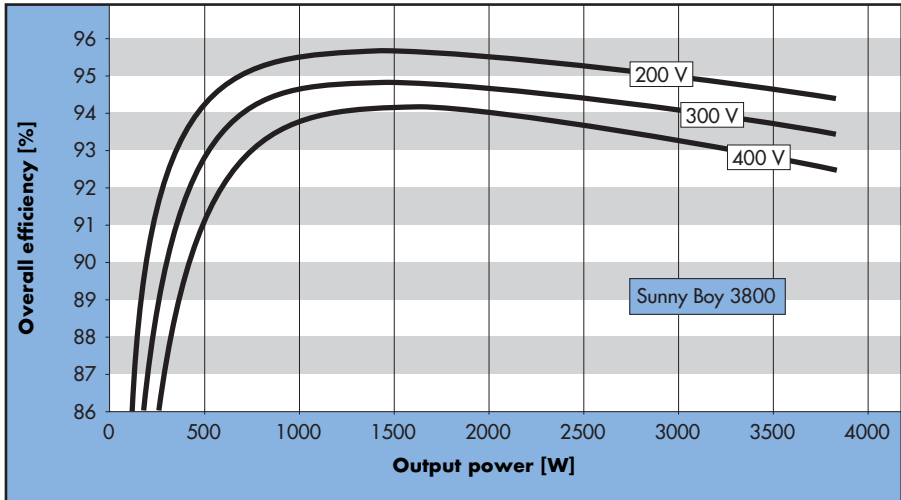

7.4 Sunny Boy 3300 / 3800 Operating parameters

Unauthorized changes to the operating parameters may result in:

- Injury or accidents as a result of changing the internal safety routines in the Sunny Boy
- Voiding the Sunny Boy's operating approval certificate
- Voiding the Sunny Boy's guarantee



Never change the parameters of your Sunny Boy without express authorization and instructions.

Grayed out parameters are only displayed in installer mode.

Name	Unit	Value range	Factory setting	
			Sunny Boy 3300	Sunny Boy 3800
Antisland-Ampl	grd	0 ... 100	0	0
Anisland-Freq	mHz	0 ... 2000	500	500
Betriebsart		MPP, lKonst, UKonst, Stopp, Turbine Mode, Insel Mode	MPP	MPP
Control		Auto, Grid, Bridge	Auto	Auto
Default			GER/ENS	GER/ENS
dFac-Max	Hz/s	0,005 ... 4,0	0,25	0,25
dZac-Max	mOhm	0 ... 2000	350	350
E_Total	kWh	0 ... 200000	0	0
Fac-delta-	Hz	0 ... 4,5	0,19	0,19
Fac-delta+	Hz	0 ... 4,5	0,19	0,19
Fac-Limit Delta	Hz	0 ... 5	1	1
Fac-Start Delta	Hz	0 ... 5	1	1
Fan-Test		0 / 1	0	0
h_Total	h	0 ... 200000		
Inst.-Code				
I-NiTest	mA	0 ... 16000	10000	10000
KI-Wind-Reg		0 ... 0,25	0,005	0,005
KP-Wind-Reg		0 ... 0,25	0,117	0,117
Netzanschluss		----, L1, L2, L3	----	----
Pmax	W	0 ... 3850 (3650)	3600	3800
P-Wind-Mid	W	100 ... 3850 (3650)	780	780
P-Wind-Ramp	W/s	10 ... 2000	650	650
Ripple-Ctl-Rcvr	on/off	on/off	off	off
Ripple-Ctl-Lev	%	1.00 - 8.00	1.70	1.70

Name	Unit	Value range	Factory setting	
			Sunny Boy 3300	Sunny Boy 3800
Ripple-Ctl-Frq	Hz	110,0 - 1600,0	216,7	216,7
Storage function		Default Parameter, Reset Operating Data, Reset Fault	none	none
Speicher/Storage		Permanent, volatile	Permanent	Permanent
T-Max-Fan	grdC	0 ... 100	90	90
T-Start	s	5 ... 1600	10 GER	10 GER
T-Start-Fan	grdC	0 ... 100	60	60
T-Stop	s	1 ... 3600	2	2
T-Stop-Fan	grdC	1 ... 100	50	50
Uac-Min	V	180 ... 300	198 GER	198
Uac-Max	V	180 ... 300	260 GER	260
UdcWindMax	V	150 ... 500	450	450
UdcWindMid	V	150 ... 500	315	315
UdcWindStart	V	150 ... 500	200	200
Upv-Start	V	200 ... 500	250	250
Usoll-Konst	V	200 ... 500	500	500

The following parameters are displayed in the parameter list but cannot be changed:

Name	Unit	Factory setting		Description
		Sunny Boy 3300	Sunny Boy 3800	
Fac-Pderating				Frequency-dependent output limitations
Fac-Tavg	ms	160	160	Averaging time of grid frequency gaging
Hardware-BFS		1.0	1.0	Hardware version of the operation control unit (BFR)
Plimit	W	3600	3800	Upper limit for AC output power
SMA-SN				Serial number of the Sunny Boy
Software-BFR				Firmware version of the operation control unit (BFR)
Software-SRR				Firmware version of the current control unit (SRR)
Uac-Tavg	ms	80	80	Averaging time of grid voltage gaging

8 Checking heat dissipation

You need only check the heat dissipation of the Sunny Boy 3300 / 3800 if, you notice a contamination of the fan screen or the inverter is increasingly observed to be in derating mode. The Sunny Boy 3300 / 3800 switching to derating mode depends on the ambient temperature and cooling efficiency.

8.1 Cleaning the fan

If the fan screen is only covered in loose dust, it can be cleaned with a vacuum-cleaner. If you do not achieve satisfactory results with a vacuum-cleaner, you can dismantle the fan for the sake of cleaning.

The Sunny Boy 3300 / 3800 is fitted with a fan on its underside. In order to clean the fan, observe the following procedure:

1. Disconnect the Sunny Boy 3300 / 3800, from both the DC and AC connections.
2. Wait for the fan to stop rotating.
3. Slide the latches in the black plastic cover aside and carefully remove these along with the filter fitted behind them. Clean the filter with a soft brush, a paint-brush, a cloth or compressed air. If the fan is very dirty, you can clean it following the procedure laid out in point 4.
4. The fan is attached to the enclosure via three plastic clips. Loosen these with a screwdriver, gently pushing into the holes where the plastic clips are located.
5. Gently remove the fan. The fan is attached with cables within the Sunny Boy 3300 / 3800. These cables are long enough for the fan to be removed for cleaning purposes. Do not pull the cables too hard in order not to damage them.
6. Clean the fan with a soft brush, a paint-brush or a cloth. Under no circumstances should you use compressed air to clean the fan as this can damage it.
7. After cleaning, replace everything in reverse order. Subsequently check that the fan is functional described in the next section.

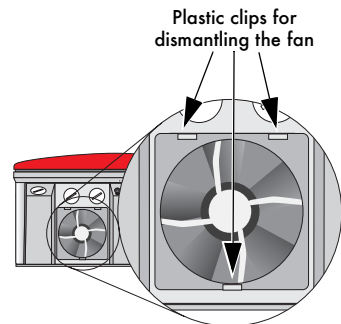
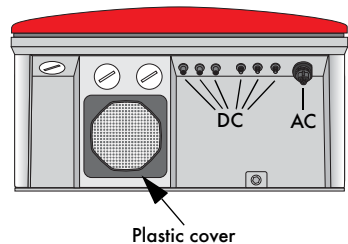

8.2 Checking the fan

If necessary, there are two ways to check the fan is functional:

- Set the "Fan Test" parameter (in installer mode) to "1" (using Sunny Data, Sunny Data Control or the Sunny Boy Control data logger).
- Place the jumper on the controller board (the jumper required to check the fan is included in the Sunny Boy 3300 / 3800 accessories kit).

Check the fan as follows:

1. Open the Sunny Boy 3300 / 3800 as described in section 6.1 "Opening the Sunny Boy" (page 31).
2. Place the jumper on the controller board socket, as laid out below.

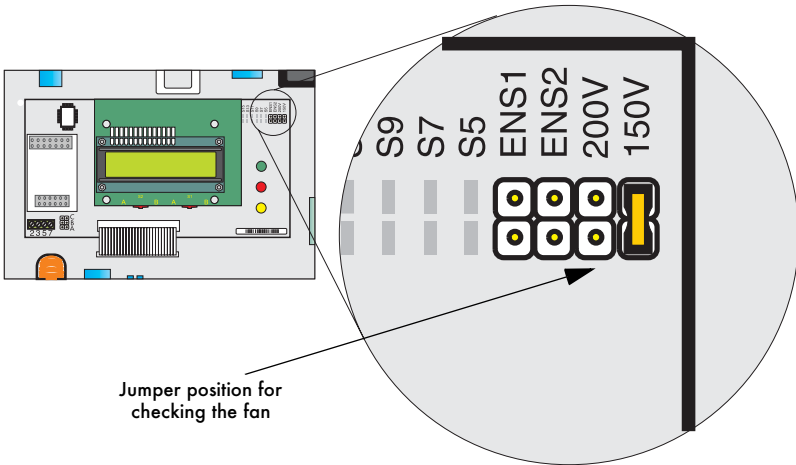

3. Close the Sunny Boy 3300 / 3800 as described in section 6.2 "Closing the Sunny Boy" (page 31).
4. The Sunny Boy 3300 / 3800 recognizes the jumper only when the system has been restarted.
5. Once you have put the jumper in position, you must restart the Sunny Boy 3300 / 3800 (all LEDs have to have been of once). Check the fan's air-flow; the Sunny Boy 3300 / 3800 sucks air in from underneath and then blows it back out on the upper left-hand side. Look out for any unusual noise which could indicate incorrect installation or that the fan is defective.
6. Once you have checked the fan, you must set the Fan Test parameter back to 0 and remove the jumper following the instructions as laid out in section 6 "Opening and closing the Sunny Boy" (page 31).

8.3 Cleaning the fan gills

There are fan gills on either side of the Sunny Boy 3300 / 3800. The Sunny Boy 3300 / 3800 sucks air in from underneath via the fan and blows it out again on the left-hand side. For optimum heat dissipation within the device, all you have to do is clean the left-hand fan gill. Proceed as follows when cleaning the fan gill(s):

- The Sunny Boy 3300 / 3800's fan gills are to be found on the side of the enclosure. Simply place your finger in the space between the top of the enclosure and the fan gill and gently pull the fan gill out of its bracket.
- Clean the fan gill with a soft brush, a paint-brush or compressed air.
- Insert the fan gills back into the Sunny Boy 3300 / 3800.

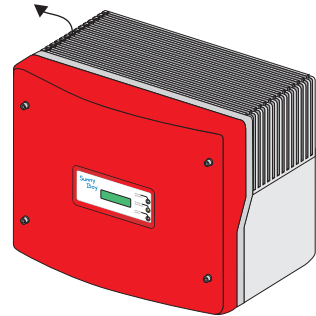

Remove the left-hand fan gill for cleaning.

Make sure that you do not mistake which fan gill is which when replacing them. The fan gills are specially designed for either side of the Sunny Boy 3300 / 3800. If you are unsure which fan gill is designed for the left-hand and which for the right-hand side of the Sunny Boy 3300 / 3800, you will find the correct side noted inside the gill at the bottom. You will find either 'Rechts/Right' or 'Links/Left' written for either side of the Sunny Boy 3300 / 3800.



9 Replacing the varistors

The Sunny Boy 3300 / 3800 is a complex high-technology device. As a result, the possibilities for fixing faults on site are limited to just a few items. Please do not try to carry out repairs other than those described here. Use the **SMA Technologie AG** exchange service and repair service instead.

If the red LED on the status display glows continuously during operation, you should first of all make sure that there is no ground contact in the PV generator.

1. Disconnect the Sunny Boy 3300 / 3800 from the AC utility (switch the line circuit breaker to its "off" position or pull out the AC plug). Make sure the grid cannot be inadvertently reconnected.

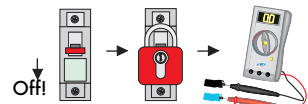

1. 2. 3.

You must make sure that no voltage is present at the AC output before opening the Sunny Boy.

2. Disconnect the DC plug connectors for all strings.

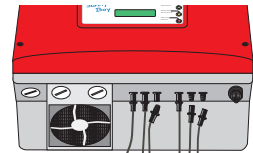

String 1
String 2
String 3

Disconnect the PV generators from the Sunny Boy.

3. Taking one DC plug connector at a time, measure the voltages between one DC plug connector of a string and earth potential. Pay attention to the safety warnings!

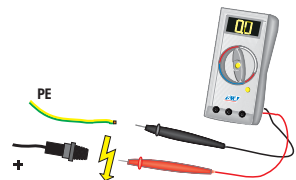

Measure the voltage between DC plug connectors and earth potential.

Caution! Dangerous high voltages may be present. Danger of death!



4. If the measured voltages are constant and if their total is roughly the same as the open circuit voltage of the string, then there is a ground contact in this string. Its approximate location can be determined from the relationships between the voltages.

5. Repeat points 3 and 4 for each string.

If you found a ground contact, it is probably not necessary to replace the varistors. Instead, make sure the ground fault is fixed. Generally the installer should be hired for this job. In this case continue as described under point 10, but without reconnecting the faulty string. Protect its DC plug against accidental touch contact (e.g. by fitting the protective caps or using sufficient high-voltage insulating tape).

If you did not find any ground contact in the PV generators, it is likely that one of the thermally monitored varistors has lost its protective function. These components are wearing parts. Their functioning diminishes with age or following repeated responses as a result of overvoltages. You can now check these varistors in the following way, paying attention to the safety information in section 2 "Safety Instructions" (page 9):

6. Remove the screws that secure the cover and remove the cover from the Sunny Boy 3300 / 3800. Make sure that no voltage is present.
7. Using a continuity tester, check all the varistors to see if there is a conducting connection between connectors 2 and 3. If there is not, then that varistor is not working. The positions of the varistors in the Sunny Boy 3300 / 3800 can be seen in the diagram in section 3.1 "Unit description" (page 11).

8. Replace the varistor concerned with a new one as shown in the drawing to the right. Ensure the varistor is installed the right way round! If you do not receive a special tool for operating the terminal clamps with your replacement varistors, please contact SMA. As an alternative, the terminal contacts can be operated using a suitable screwdriver. Since the failure of one varistor is generally due to factors that affect all varistors in a similar way (temperature, age, inductive overvoltages), it is highly recommended that you replace both varistors, not just the one that is obviously defective. The varistors were specially manufactured for use in the Sunny Boy 3300 / 3800 and are not commercially available. They must be ordered directly from **SMA** Technologie AG (SMA order code: SB-TV4).

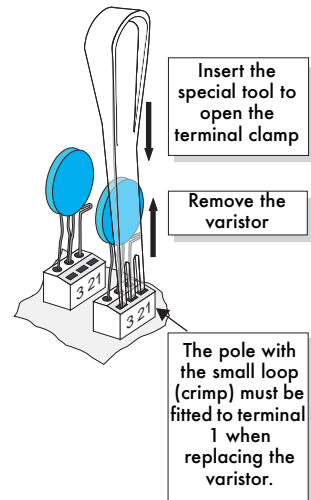

If no spare varistors are available on site, the Sunny Boy 3300 / 3800 can still feed into the grid. The input is no longer protected against overvoltages! Replacement varistors should be obtained as soon as possible. In systems with a high risk of overvoltages, the Sunny Boy 3300 / 3800 should not be operated with defective varistors!



9. Close the Sunny Boy 3300 / 3800. Do not forget to reattach the washers with the indentations facing toward the lid.
10. Connect up the faultless PV generator strings to the inverter.
11. Close the unnecessary DC input sockets with the caps included in the delivery.

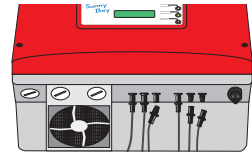

String 1
String 2
String 3

12. Switch the line circuit breaker to the "on" position.
13. Now check whether the LED display on the Sunny Boy 3300 / 3800 indicates that the device is functioning correctly.

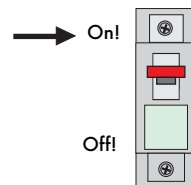

If no ground contact and no defective varistor were found, there is probably a fault in the Sunny Boy. In this case, contact the SMA hotline to discuss what to do next.

10 Rating for a line circuit breaker

Example for the thermal rating for a line circuit breaker in a photovoltaic electrical power unit operated in parallel with the low-voltage grid.



We assume a PV system with 9 Sunny Boy 3300 / 3800 inverters, with three inverters per phase.

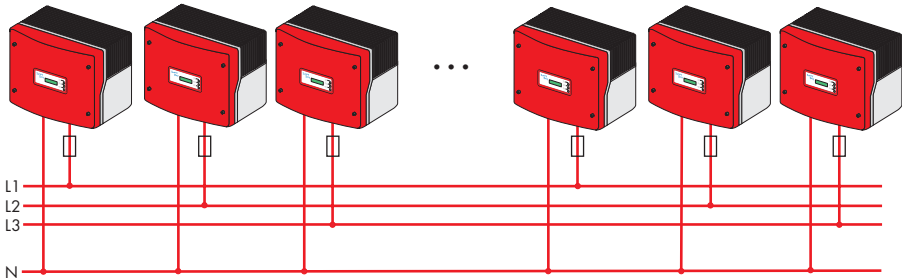

Required technical information for the inverters used:

- Maximum output current = 17 A (Sunny Boy 3300), 18 A (Sunny Boy 3800)
- Maximum permissible fuse protection for the inverter = B 25 A

The choice of cable together with the way it is routed, ambient temperatures and other underlying conditions limit the maximum fuse protection for the cable.

- In our example we assume that the chosen cable (4.0 mm²) is ideally routed and can take a nominal current of 21 A.

Selecting a line circuit breaker:

- The maximum possible nominal current for the cable used and the maximum possible fuse protection for the inverter now limit the maximum possible nominal current for the line circuit breaker.
- In our example, 20 A is possible.

However, the thermal suitability of the line circuit breaker still needs to be checked.

When selecting line circuit breakers, a number of load factors need to be taken into account. These can be found in the respective data sheets.



Example for the thermal selection of a 20 A line circuit breaker with B sensitivity with no gap between the circuit breakers.

For example, one manufacturer's circuit breaker may be designed for an ambient temperature of 50 °C.

Load factors according to data sheet specifications:

- Reduction through permanent load $>1 \text{ h} = 0.9^1$
- Reduction when 9 circuit breakers are arranged side-by-side without gaps
= 0.77^2
- Increase in nominal current as a result of ambient temperatures of 40 °C in the circuit breaker panel = 1.07^3

Result:

The nominal load current for the line circuit breaker is calculated as:

$$I_{bn} = 20 \text{ A} \times 0.9 \times 0.77 \times 1.07 = 14.83 \text{ A}$$

-
1. Permanent loads of longer than 1 hour are possible in photovoltaics.
 2. When only one circuit breaker is used, this factor = 1
 3. Because the circuit breakers are rated for 50 °C

Summary

The selected line circuit breaker cannot be used in our example case since the maximum current-carrying capacity for fault-free operation is lower than the maximum output current of the inverter used. **It will trip under rated operating conditions!**

In this case one solution would be to ensure there is an 8 mm gap between the circuit breakers. This would mean that the reduction factor is 0.98 instead of 0.77. As a result, the maximum current-carrying capacity would be 18.87 A.

In addition to the thermal rating of the circuit breakers, the boundary conditions as laid out in section "Rating for a line circuit breaker in a photovoltaic electrical power unit operated in parallel with the low-voltage grid" (page 18) and the applicable DIN VDE standards¹ also need to be taken into account, of course. The main ones that apply here are:

- DIN VDE 0100 Part 410 and/or the international standard IEC 60364-4-41:1992
- DIN VDE 0100 Part 430 and/or the international standard IEC 364-4-43:1977 and IEC 364-4-473:1977
- DIN VDE 0298 Part 4

In special applications the relevant standards must be followed.

1. The standards listed here are standards that apply in Germany. Please note that other standards apply in other countries. Beside the standards above other standards may be applicable in special installations.

11 The communications interface

Installation or replacement of the communications interface is only to be carried out by a trained electrician.



The communications interface is used to communicate with SMA communication devices (e.g. Sunny Boy Control, Sunny WebBox) or a PC with appropriate software (e.g. Sunny Data Control). Depending on the selected communications interface, up to 2500 inverters can be interconnected. Detailed information on this topic can be found in the communication device manual, or on the Internet at www.SMA.de.

The detailed wiring diagram for the individual communications interfaces can be found in the communication device manual. This wiring diagram includes:

- specifications of the necessary cable type
- which of the inverter's connections are used
- whether jumpers need to be mounted, and if so, which jumpers
- whether the PE needs to be connected to the cable shield

The next pages will describe the following:

- the housing feed-throughs for the communications interface
- the permitted cable route in the Sunny Boy
- the location of the PE connector
- the location of the screw terminals for connection of communication wires
- the location of the jumper slots
- the location of the interface port

11.1 Connection of the communications interface



When opening the Sunny Boy, follow all the safety instructions as described in chapter 2.



Electrostatic discharges are an acute danger to the Sunny Boy and to the communications interface. Ground yourself by touching PE before removing the communications interface from the packaging, and before touching any components within the Sunny Boy.



Read the communication device manual before beginning installation work. Further wiring details can be found there.

1. Open the inverter as described in chapter 6.1.
2. Guide the PG screw fitting over the communication cable.
3. Thread the cable through one of the three possible cable feed-throughs (A) on the Sunny Boy.
4. Screw the PG screw fitting onto the Sunny Boy.
5. Sheathe the cable inside the Sunny Boy using the silicon tube provided. The silicon tube is imperative for safety reasons. Without this silicon tube, the interface is not to be operated.
6. Lay the cable in area (B) as shown in the figure to the right.
7. Ground the cable shield at the PE connector (C) if the terminal connection diagram of the communication device indicates this as necessary.
8. Connect the communication wires to the screw terminal strip (D) as described in the terminal connection diagram of the communication device. Note down the connector color coding for the respective pin numbers. Connecting the receiver incorrectly can cause the devices to be damaged.
 - Pin 2 color: _____
 - Pin 3 color: _____
 - Pin 5 color: _____
 - Pin 7 color: _____
9. Connect the jumpers (E) if the terminal connection diagram of the communication device indicates this as necessary. The table shown to the right provides an overview of the jumper functions.
10. Plug the communications interface into the board (F).
11. Close the Sunny Boy as described in chapter 6.2.

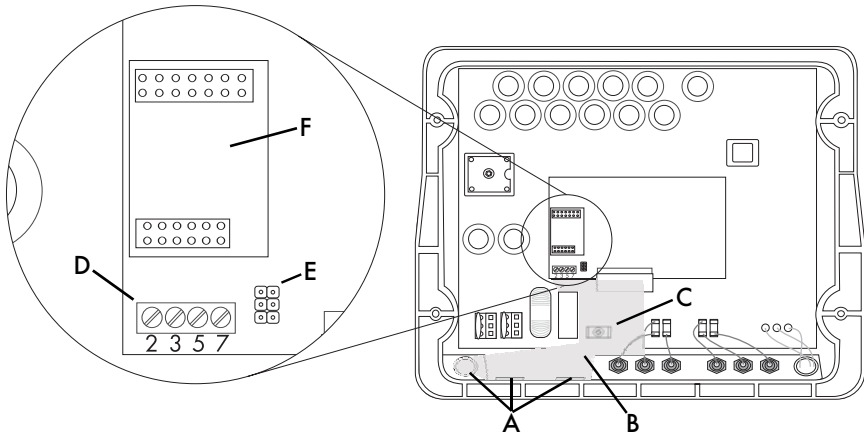

- A Housing feed-throughs in the base of the Sunny Boy (for wireless link, only use the central housing feed-through)
- B Cable route (gray surface)
- C PE connector
- D Screw terminals for connection of the communication wires
- E Jumper slot
- F Interface port

11.1.1 Jumper functions

	Jumper A	Jumper B	Jumper C
RS232	-	-	-
RS485	Termination	Bias 1	Bias 2
NLM	-	-	-
Wireless	-	-	-

A detailed description of the jumper functions can be found in the communication device manual.



12 Contact

If you have any questions or technical problems concerning the Sunny Boy 3300 / 3800, please contact our hotline. Please have the following information available when you contact SMA:

- Inverter type
- Type and number of the modules
- Communication method
- Serial number of the Sunny Boy



Address:

SMA Technologie AG
Hannoversche Strasse 1 - 5
34266 Niestetal
Germany

Tel.:+49 (0)561 95 22 - 499
Fax:+49 (0)561 95 22 - 4699
hotline@SMA.de
www.SMA.de

SMA Technologie AG

www.SMA.de

Hannoversche Straße 1-5

34266 Niestetal

Germany

Tel. +49 561 9522 0

info@SMA.de



SMA Solartechnology China

International Metro Center,
Building A, City Square No. Jia 3,
Shilipu Road, Changyang District
100025 Beijing, P.R. China
Tel. +86 10 65 58 78 15
www.SMA-CHINA.com

Vertrieb SMA Italien

Via Lorenzo Valla, 16
20141 Milano
Italy
Tel. +39 02 847421

SMA America, Inc.

12438 Loma Rica Drive, Unit C
Grass Valley, CA 95945, USA
Tel. +1 530 273 4895
www.SMA-AMERICA.com

Vertrieb SMA Spanien

Balmes, 297
08006 Barcelona
Spain
Tel. +34 639 403683

Innovation in Systemtechnik
für den Erfolg der Photovoltaik

