

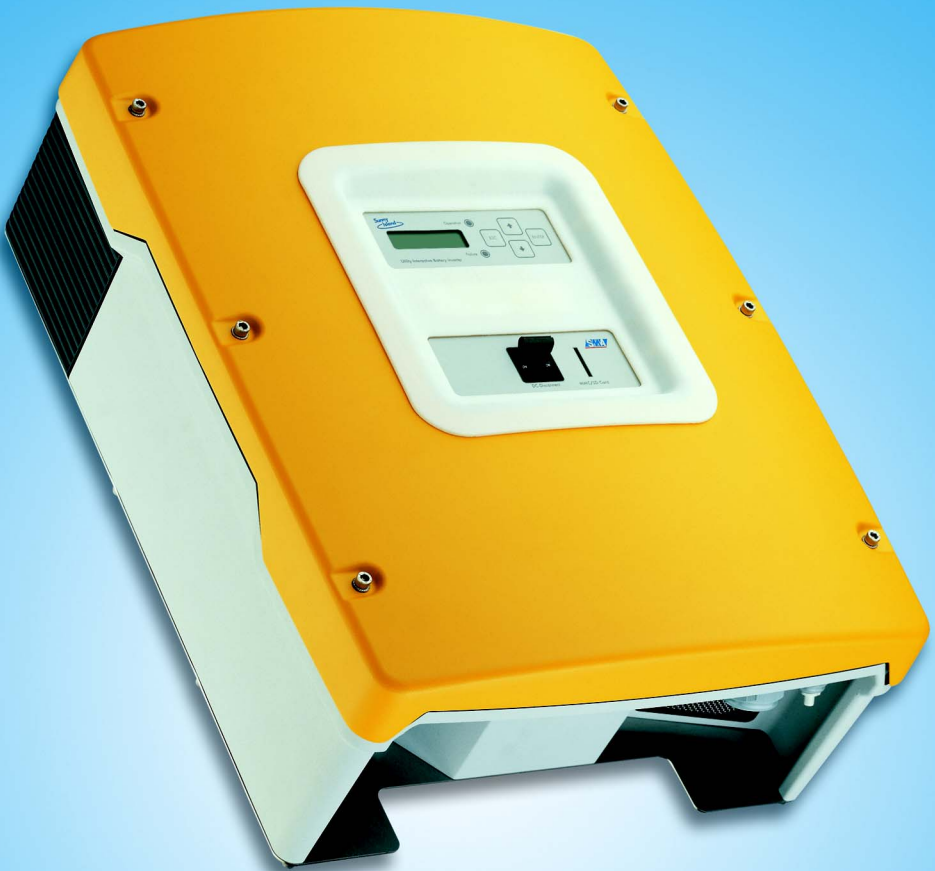

# Sunny Island 5048 Installation & Instruction Manual

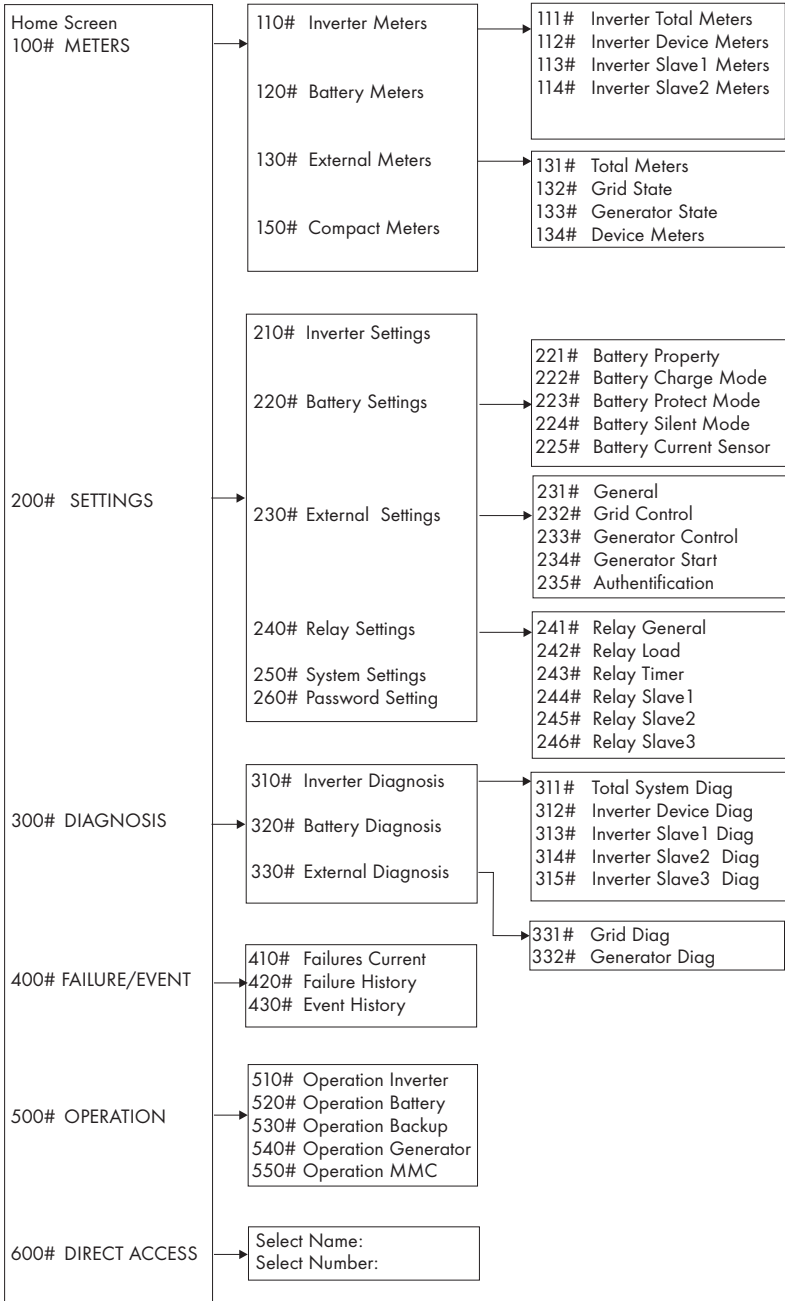



# Table of Contents

<b>1</b>	<b>Notes on this Manual.</b>	<b>9</b>
1.1	Validity	9
1.2	Symbols Used	9
1.3	Syntax.	10
<b>2</b>	<b>The Sunny Island 5048.</b>	<b>11</b>
2.1	Properties	11
2.2	At a Glance.	15
2.3	Dimensions	16
2.4	Scope of Delivery.	17
2.5	Required Tools and Resources	18
2.6	Type Plate/Firmware Version.	19
<b>3</b>	<b>Safety Instructions</b>	<b>21</b>
3.1	Important Notes Regarding Operation	21
3.2	Potential Hazards.	22
<b>4</b>	<b>Mounting the Device</b>	<b>25</b>
4.1	Preparation	25
4.1.1	Lifting/Moving.	25
4.1.2	Unpacking	25
4.1.3	Minimum Clearance.	26
4.1.4	Wall Mounting	26
<b>5</b>	<b>Opening and Closing.</b>	<b>29</b>
5.1	Opening the Device	29
5.2	Closing the Device	30

<b>6</b>	<b>Electrical Connection</b>	<b>31</b>
6.1	Grounding	32
6.2	DC Connection	34
6.2.1	Safety Precautions/Conditions	34
6.2.2	Cable Protection	35
6.2.3	Connection	35
6.3	AC Connection	36
6.3.1	Cable Protection	36
6.3.2	AC1 (Loads/Sunny Boys)	37
6.3.3	AC2 (Generator/Grid)	38
6.4	Additional Connections	40
6.4.1	Battery Temperature Sensor	40
6.4.2	Battery Current Sensor	41
6.4.3	Communication for Multi-Device Connection	45
6.4.4	Multi-function Relays 1 and 2	47
6.4.5	BatVtgOut Power Supply	49
6.4.6	Digital Input DigIn	50
6.5	Interface for External Communication	51
6.5.1	Connection of the Interface	52
6.5.2	Data Transmission Rate	53
<b>7</b>	<b>Control Elements</b>	<b>55</b>
7.1	Display Messages	55
7.2	DC Circuit Breaker	55
7.3	Keys	56
7.4	Explanation of the Light-emitting Diodes (LEDs)	56
7.5	MMC/SD Card	56
<b>8</b>	<b>(First) Commissioning</b>	<b>57</b>
8.1	Requirements	57
8.2	Starting the Quick Configuration Guide (QCG)	57

<b>9</b>	<b>Switching On and Off</b> . . . . .	<b>61</b>
9.1	Switching On/Starting . . . . .	61
9.2	Stopping . . . . .	62
9.3	Switching Off . . . . .	63
9.4	Disconnecting the Device from Voltage Sources. . . . .	63
9.5	Restarting the System after Automatic Shutdown. . . . .	64
<b>10</b>	<b>Operation</b> . . . . .	<b>67</b>
10.1	Menu Structure. . . . .	68
10.2	Changing Parameters . . . . .	71
10.3	Direct Access . . . . .	72
10.4	Compact Meters. . . . .	72
10.5	Entering the Installer Password . . . . .	74
10.6	Display Messages (Overview) . . . . .	75
10.7	Parameter Display . . . . .	78
10.8	Display of Events . . . . .	78
10.9	Display of Warnings and Failures. . . . .	78
<b>11</b>	<b>Saving Data on an MMC/SD Card.</b> . . . . .	<b>81</b>
11.1	Inserting the Card. . . . .	83
11.2	Removing the Card. . . . .	84
11.3	Loading and Saving Parameters. . . . .	84
11.4	Writing Log Data . . . . .	84
11.5	Status Messages. . . . .	85
11.6	Firmware Update . . . . .	86

<b>12</b>	<b>Additional Functions</b>	<b>89</b>
12.1	Load Shedding	89
12.2	Sleep Mode	90
12.3	Time-controlled Operation	90
12.4	Overload and Short Circuit Behavior	91
12.5	Device Failure and Autostart	91
12.6	Automatic Frequency Adjustment	91
<b>13</b>	<b>Battery Management</b>	<b>93</b>
13.1	Battery Temperature	93
13.2	Start Options	94
13.3	Charge State/SOC and SOH	94
13.4	Charge Control	96
13.4.1	Boost Charge	98
13.4.2	Full Charge	98
13.4.3	Equalization Charge	99
13.4.4	Manual Equalization Charge	99
13.4.5	Silent Mode	100
13.5	Battery Preservation Mode	100
13.6	Battery Diagnostics	101
<b>14</b>	<b>Connecting External Sources</b>	<b>103</b>
14.1	Generator	103
14.1.1	Connecting Generator Connections in Parallel	103
14.1.2	Generator Start Options	104
14.1.3	Generator Operation	108
14.1.4	Manual Generator Operation	108
14.1.5	Automatic Generator Operation	110
14.1.6	Limits and Power Adjustment	114
14.1.7	Run Times	115
14.1.8	Operation Together With Sunny Boys	116
14.1.9	Stopping the Generator	116
14.1.10	Stopping the Sunny Island 5048	117

14.1.11	Failures . . . . .	118
<b>14.2</b>	<b>Grid . . . . .</b>	<b>118</b>
14.2.1	Conditions . . . . .	118
14.2.2	Starting up Sunny Island 5048 . . . . .	119
14.2.3	Stand-Alone Grid Operation . . . . .	119
14.2.4	Grid Reconnection . . . . .	119
14.2.5	Grid Operation . . . . .	119
14.2.6	Grid Failure . . . . .	120
14.2.7	Failures . . . . .	120
14.2.8	Limits and Power Adjustment . . . . .	121
14.2.9	Operation Together With Sunny Boys . . . . .	122
14.3	Generator and Grid . . . . .	122
<b>15</b>	<b>Relay . . . . .</b>	<b>125</b>
<b>16</b>	<b>Multicluster Operation . . . . .</b>	<b>126</b>
<b>17</b>	<b>Sunny Boy . . . . .</b>	<b>127</b>
17.1	Connection to the Stand-alone Grid . . . . .	127
17.2	Setting the Stand-alone Grid Parameters . . . . .	128
17.3	Frequency Shift Power Control (FSPC) . . . . .	129
<b>18</b>	<b>Maintenance and Care . . . . .</b>	<b>131</b>
18.1	Housing . . . . .	131
18.2	Cleaning the Fans . . . . .	131
18.3	Display . . . . .	131
18.4	Functioning . . . . .	131
18.5	Battery . . . . .	132
18.6	Disposal . . . . .	132

<b>19</b>	<b>Parameter Lists. . . . .</b>	<b>133</b>
19.1	Display Values . . . . .	134
19.2	Adjustable System Parameters . . . . .	139
19.3	Diagnostistics . . . . .	150
19.4	Events, Warnings and Failures (History) . . . . .	155
19.5	Function in Operation . . . . .	155
<b>20</b>	<b>Troubleshooting/Problem Solving . . . . .</b>	<b>157</b>
20.1	Failure Approval . . . . .	157
20.2	Autostart Handling . . . . .	157
20.3	Master-Slave Handling . . . . .	157
20.4	Handling Present Failures During Startup. . . . .	158
20.5	Display of Failures and Events . . . . .	158
20.6	Events . . . . .	158
20.7	Failure Categories . . . . .	161
20.8	Warnings and Failure messages. . . . .	161
20.9	Troubleshooting . . . . .	166
20.10	Procedure During Emergency Charge Mode. . . . .	169
<b>21</b>	<b>Optional Devices . . . . .</b>	<b>173</b>
21.1	Accessories (Optional) . . . . .	173
21.2	SMA Products (Optional) . . . . .	174
<b>22</b>	<b>Technical Data . . . . .</b>	<b>175</b>
<b>23</b>	<b>CE Declaration of Conformity. . . . .</b>	<b>179</b>
<b>24</b>	<b>Contact. . . . .</b>	<b>181</b>
<b>25</b>	<b>Glossary . . . . .</b>	<b>183</b>



# 1 Notes on this Manual

This technical description is intended both for the installer and the end customer. Its purpose is to assist in correctly mounting, installing and operating as well as understanding the operating principles of a Sunny Island 5048.

Information to the following topics is available in the respective sections:

- Installation                    section 2 "The Sunny Island 5048" (Page 11)
- Commissioning            section 7 "Control Elements" (Page 55)
- Functioning                section 12 "Additional Functions" (Page 89)
- Appendix                    section 18 "Maintenance and Care" (Page 131)

## 1.1 Validity

This description applies to firmware version FwVer 3.012

The firmware version of the device can be obtained with the "312.02 FwVev"parameter (see section 19.3 "Diagnostics" (Page 150)).

This product may only be operated within the borders and the intended area of application described in this document.

Do not use the Sunny Island 5048 for purposes other than those indicated in this description. Use of the device for other purposes can void the warranty as well as damage both the device and the system.

If you require further information, please contact the Sunny Island Hotline at +49 561 95 22 399 or by email: Sunny.Island.hotline@SMA.de.

## 1.2 Symbols Used

To ensure optimum use of these instructions, please note the following explanations of symbols used.

**This symbol indicates a danger.**

**If these instructions are ignored, a significant danger of injury or death arises and damage to the device, system or plant may also result.**



*This symbol indicates a notice.*

*Failure to observe the advice can cause difficulties in the current working step and can possibly also hinder optimum operation of the device.*



This symbol indicates an example.

Here you will find further concrete examples of operations and device behavior.



## 1.3 Syntax

The following syntax for menus and parameters apply to the entire document:

**Menu:** menu number, hash mark and names (120# Battery Meters)

**Parameter:** menu number, dot, parameter number and name (120.02 BatVtg).

## 2 The Sunny Island 5048

### 2.1 Properties

The Sunny Island 5048 is a bi-directional battery inverter (battery inverter and charger) for off-grid systems. The Sunny Island 5048 supplies consumers on the stand-alone grid side and charges battery banks with the energy from grid-feeding units connected on the AC side.

The comfortable support of AC- and DC coupling as well as the expandability of the systems with the Sunny Island 5048 guarantee highest flexibility. In addition, innovative technology allows the Sunny Island 5048 to achieve a maximum efficiency of more than 95 %. Optimized for partial load operation it impresses with a low open-circuit and standby consumption. Because of its high overload capability and the integrated power management, an over-dimensioning of the Sunny Island is not necessary.

The parallel operation of up to four devices on a single phase of a battery or three devices on a three-phase system enables the Sunny Island 5048 to set up stand-alone power supply systems with outputs ranging from 3 kW to 26 kW.

Thanks to its sophisticated generator management it can control connected diesel generators in a particularly gentle and fuel-saving manner. It can also be integrated into the public grid. The Sunny Island 5048 can also automatically deactivate loads if the battery does not provide sufficient electrical energy.

The stand-alone grid's critical component, the battery, is monitored diligently and optimally utilized. The intelligent battery management precisely records the battery's state of charge. This makes an improved utilization of the battery capacity possible, which also means that smaller and thus more cost-effective batteries can be used without affecting performance.

In order to prevent premature aging caused by incorrect charging and frequent deep discharge, the Sunny Island 5048 has an intelligent charge control and reliable deep discharge protection. Because of these functions the battery service life can be largely extended in comparison with simpler devices.

Despite the complex function of this battery inverter, the Sunny Island 5048 is easy to configure. All settings required for operation can be quickly and easily programmed in ten steps using the "Quick Configuration Guide". Because of the concept of central operation referred to as "Single Point of Operation" the system/cluster parameters are only set on the master device. All other devices automatically adopt the configuration. The easy-to-understand menu navigation allows quick access to all important data, even while the system is running. An MMC/SD card provides easy system control and thus simplifies any service works.



*Always use the MMC/SD card for saving data and events. In case of a failure SMA Technologie AG can thus quickly help you.*

The Sunny Island 5048 monitors the set voltage and frequency limits on the grid and generator. If these limits are not observed, it disconnects from the external source without interruption and changes to stand-alone grid operation. The Sunny Island 5048 also has an integrated anti-islanding process in order to prevent unintended islanding on the public grid. If this process is triggered, the system also completely changes to stand-alone mode without interruption.

The Sunny Island 5048 can be integrated into different system configurations. The graphic on the following page shows which components can be integrated into a Sunny Island system.

The graphics on the page after next show the different wiring options (1-phase, 1-phase parallel and 3-phase).

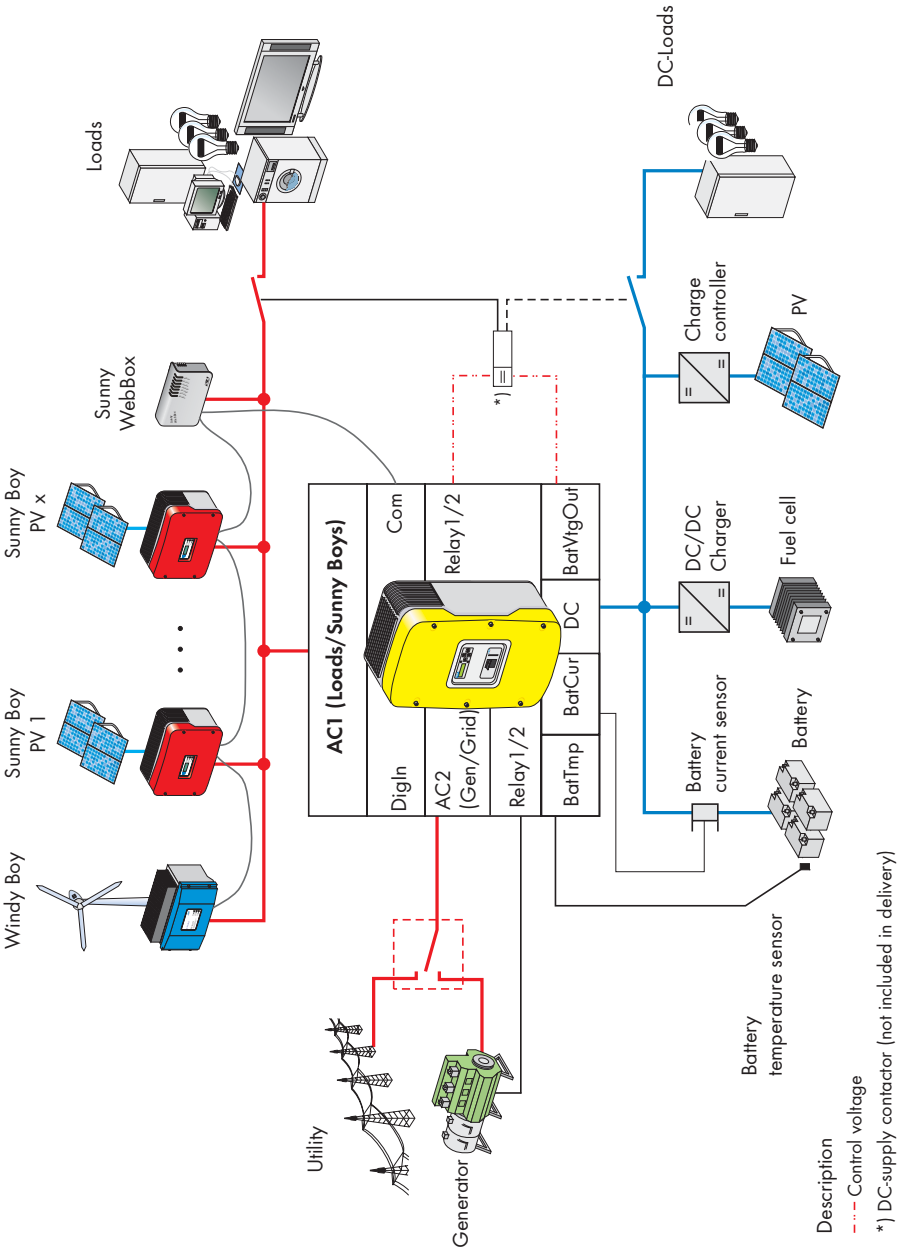

### 1-phase

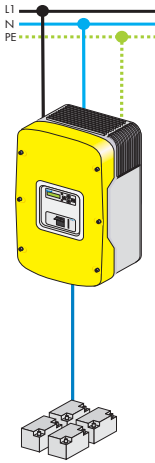

### 1-phase parallel

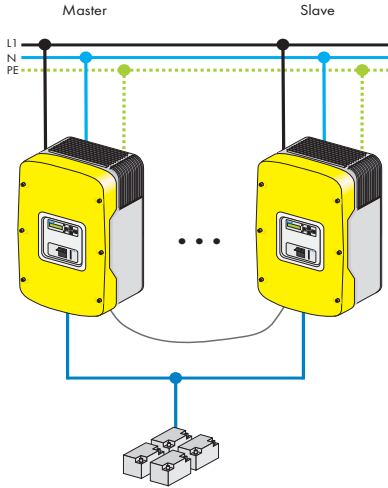

### 3-phase

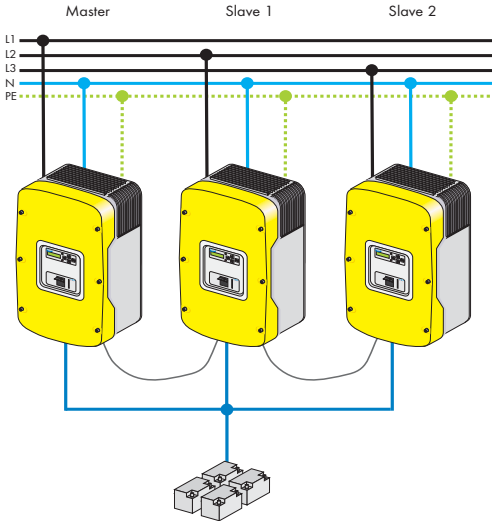

## 2.2 At a Glance

The following figure provides an overview of all control elements and connections of the Sunny Island 5048.

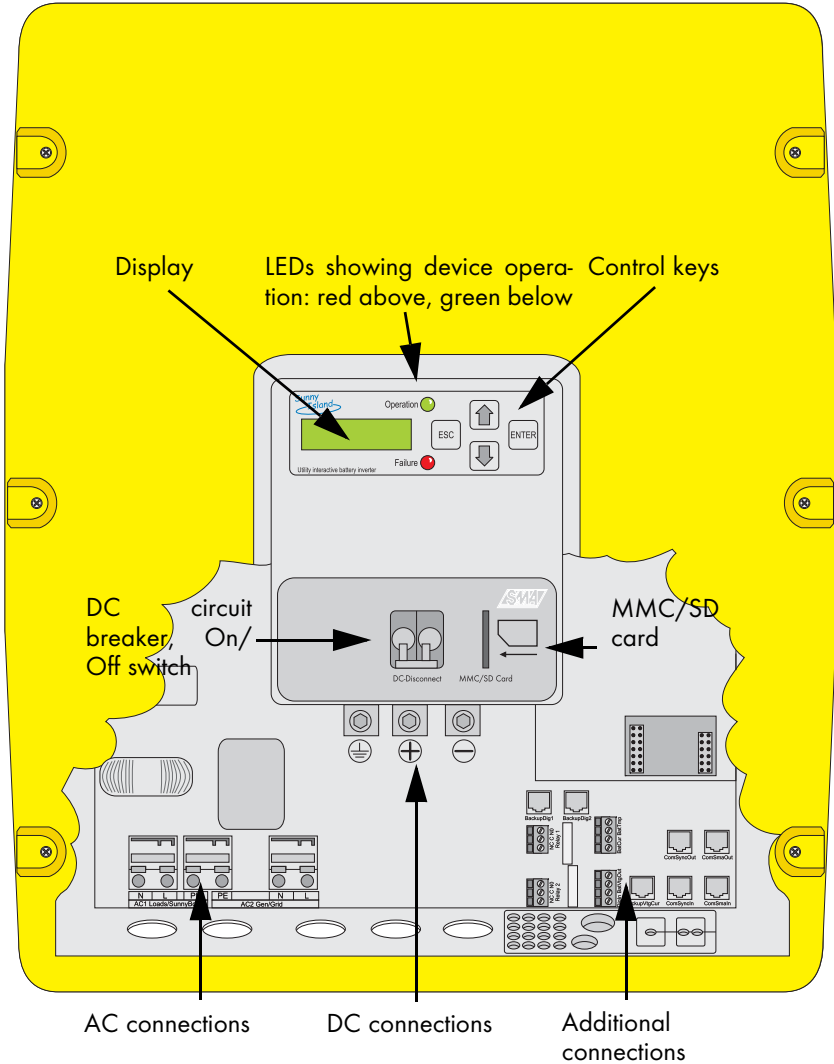

## 2.3 Dimensions

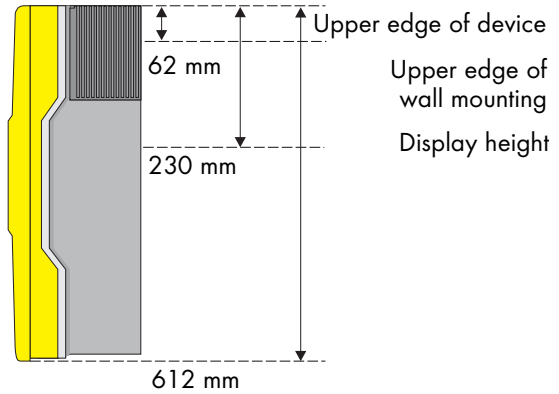
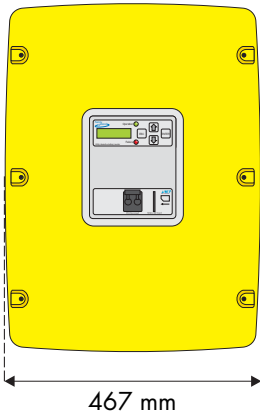
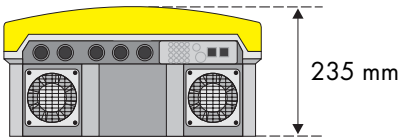



## 2.4 Scope of Delivery

The following elements are included:

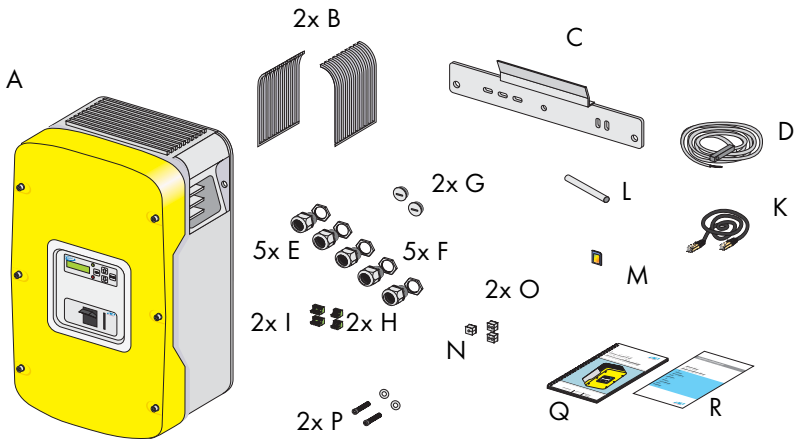

A	1	Sunny Island 5048 with cover,
B	2	ventilation grills
C	1	wall bracket
D	1	battery temperature sensor
E	5	M25 metric-thread cable screw
F	5	M 25 nuts
G	2	metric-thread dummy plugs
H	2	3-pin print terminals (for connecting relays 1 & 2)
I	2	4-pin print terminals (for connecting battery temperature/current sensor)
K	1	RJ45 communication cable (black 2 m) for internal communication (between several Sunny Island 5048)
L	1	silicone tube 10 mm x 0.5 m
M	1	128 MB SD card
N	1	rubber plug for feed-through of one cable
O	2	rubber plug for feed-through of two cables
P	2	M6 x 10 mm hexagon socket screws incl. M6 contact washers for attaching the Sunny Island 5048 to the wall bracket

- Q 1 installation and operation manual  
R 1 "Warranty and Guaranty Conditions" form

## 2.5 Required Tools and Resources

The following tools and materials are recommended for mounting and installing the Sunny Island 5048:

### Tools (not included in delivery)

Stripping pliers

Cable end sleeves

Drill

Suitable drill (e.g. stone drill), Ø 10 mm

Torque wrench (4 Nm up to 5.7 Nm) with flathead screwdriver adapters in 10/5.5/2.5 mm

Allen key, 3 mm to 8 mm

Cable knife

Combination pliers

Phillips screwdriver, PH1 and PH2

Cable

Open-end/ring wrenches or socket wrench in the sizes 10/19/24/30

Multimeter

Crimping tool for the cable lugs (suitable for cable cross-sections of 70 mm<sup>2</sup>)

Flathead screwdriver, 0.4 x 2.5 mm/1.0 x 10 mm/1.0 x 5.5 mm

Diagonal cutting pliers

Spirit level

### Material (not included in delivery)

Wall anchors for the wall bracket (e.g. SX 10)

Cable ties

M8 ring cable lugs

Heat shrink tubing

Hexagon bolts, 8x60 mm, washers

## 2.6 Type Plate/Firmware Version

You can identify the Sunny Island 5048 by the type plate and firmware version.

- The type plate is located on the left side of the housing.
- The firmware version of the device can be obtained with the "312.02 FwVer"parameter (see section 19.3 "Diagnostics" (Page 150)).

# Sunny Island

Utility Interactive Battery Inverter



www.sma.de  
SMA Technologie AG  
Hannoversche Straße 1 - 5  
34266 Niestetal, Germany  
Hotline : +49 (0)561 - 9522 - 399

	Type <b>SI5048</b>	Serial Number <b>125600XXXX</b>	T1
<b>A</b>	<b>DC</b> Maximum system voltage	<b>63 V =*</b>	<b>AC</b> Nominal output voltage
			<b>230 V ~*</b>
<b>B</b>	<b>DC</b> Range of operating voltage	<b>41...63V =*</b>	<b>AC</b> Operating voltage range
			<b>202...253V ~*</b>
<b>C</b>	<b>DC</b> Nominal output voltage	<b>48 V =*</b>	<b>AC</b> Nominal output Frequency
			<b>50 Hz*</b>
<b>D</b>	<b>DC</b> Charging output voltage operation range	<b>41...63V =*</b>	<b>AC</b> Operating frequency range
			<b>45...65 Hz*</b>
<b>E</b>	<b>DC</b> Maximum operating current	<b>200 A =</b>	<b>AC</b> Maximum continuous output current
			<b>21,7 A ~</b>
<b>F</b>	Operating temperature range	<b>-25...+50 °C</b>	<b>AC</b> Maximum input current (pass thru)
			<b>56 A ~</b>
<b>G</b>	Degree of protection	<b>IP40</b>	<b>AC</b> Maximum output fault current
			<b>100 A ~</b>
<b>H</b>	Manufactured	<b>3Q/2006</b>	<b>AC</b> Maximum continuous output power
			<b>5000 W/25 °C</b> <b>4000 W/45 °C</b>

\* Value adjustable

For more detailed data refer to installation & operating instruction



I  
K  
L  
M  
N  
O  
P  
Q



## 3 Safety Instructions

### 3.1 Important Notes Regarding Operation

Please follow all operating and safety instructions in this manual. If these instructions are ignored, a significant danger of injury or death arises and damage to the device, system or plant may also result. Carefully read the safety instructions **before** installing and commissioning the device. Ensure that the safety instructions and handbook are stored in an easily accessible location.

**Be sure to observe all applicable regional standards and guidelines.**



**The Sunny Island 5048 may only be installed or opened by qualified personnel (electricians).**



**Never attempt to repair the device yourself. Unprofessional repair work can be dangerous. Please consult your dealer or the SMA Technologie AG if a fault occurs.**



**Danger of Destruction of the Device!**

**When installing pay attention that only the same type of Sunny Island 5048 is used. Never install 230 V and 120 V types in parallel with respect to the different voltage levels.**



**The operating consumption of the Sunny Island 5048 discharges the batteries, in standby mode this load is about 4 W and in idle mode it is about 25 W. You should take note of this when you wish to install the Sunny Island 5048**



- **but do not wish to use it immediately or**
- **for a long time in the year.**

**In these cases, you should set the Sunny Island 5048 to Stop mode (see section 9.3 "Switching Off" (Page 63)) and disconnect it from the batteries via the DC circuit breaker.**

## 3.2 Potential Hazards

Like any other power converter, the Sunny Island 5048 is an electrical device that presents certain hazards when operated.



**Life-threatening voltages and currents exist within the Sunny Island 5048. Complete protection against accidental contact is only provided when the following points are followed according to the manual:**

- the device has been fitted correctly
- the device has been properly grounded
- all connections to the device are made correctly
- the cover of the housing is subsequently securely closed

**Failure to observe the advice can lead to serious injury or death and can also damage the device.**



**Before performing any maintenance or installation work on the Sunny Island 5048, you must make absolutely sure that all devices built in or connected to the system are completely isolated from all voltage sources (batteries, (stand-alone grid, generator). Ensure that the system cannot be accidentally switched on again. Proceed in the order given below:**

- Switch off all consumer appliances.
- Press and hold the "ENTER" key until the "Hold key to stop" message appears.
- Press and hold the "ENTER" key until the Sunny Island 5048 stops and the "STANDBY-To start press <ENTER>" message appears.
- Switch off the Sunny Island 5048 using the DC circuit breaker and also disconnect the device from the batteries (e.g. using the optional SI-BattCase load disconnecting switch).
- Then disconnect the Sunny Island 5048 from the grid/generator and island grid (AC1 und AC2).
- Make sure that the Sunny Island 5048 has been disconnected from all voltage sources.
- Wait at least five minutes to let the capacitors discharge and allow the voltage inside the device to drop to a safe level. The capacitors need approx. half an hour for completely discharging. A short-circuit on the DC side has to be avoided by all means.
- Open the housing cover to ensure that the device is not under voltage.

The Sunny Island 5048 can start up on its own. When working on the stand-alone grid, ensure that ALL sources of AC and DC power in the system have been switched off (see above).



When touching the device, please note that some housing components of the Sunny Island 5048 heat up during operation. Temperatures may exceed 60°C. This represents a risk of burns.



This device has NOT been developed to supply life-sustaining medical devices. The Sunny Island 5048 may not be used in installations where a power outage could result in personal injury.



This device is suitable only for installation in enclosed spaces. Therefore, do not expose it to moisture, rain or direct sunshine (IP category 40).



The Sunny Island 5048 has been designed for use at elevations up to 3000 m above sea level. Please contact **SMA** Technologie AG before using the device at elevations above 3000 m.



At a height of 2000 m and more above sea level a power loss of 0.5 % / 100 m can be assumed!





## 4 Mounting the Device

Take note of the required installation conditions specified in the sections below **before** mounting, installing and commissioning the Sunny Island 5048.

### 4.1 Preparation

#### 4.1.1 Lifting/Moving

The Sunny Island 5048 weighs 63 kg. Ensure that at least three people are available for installing the device. Always wear personal protective equipment (protective clothing, gloves, safety boots) to avoid the danger of injuries.



*The black ventilation flaps on the right and left side on the upper part of the Sunny Island 5048 can be removed for transport with respect to the fact that comfortable **handles** are located under these flaps. The ventilation flaps are not mounted when delivered, they are inserted after installation (they snap in place).*



#### 4.1.2 Unpacking

Before installing the Sunny Island 5048 make sure that all parts are included in the delivery.

- Carefully check the packaging and the Sunny Island 5048 for any signs of damage.
- Ensure that all parts are included in the delivery (see section 2.4 "Scope of Delivery" (Page 17)).
- Enter the type and serial number of the device into the "Guarantee and Warranty Conditions" form.
- Keep the documents in a location where they will be easy to find later.

*Remove the type that covers both the outer and inner holes for the cable feed-through. It prevents contaminants from entering the housing during transport.*



If something is missing or the Sunny Island 5048 has been damaged during shipment, contact immediately **SMA** Technologie AG. Further information is provided in section .24 "Contact" (Page 181).

*Keep the packaging in case you need to return the battery inverter or its accessories.*



### 4.1.3 Minimum Clearance

Air enters the Sunny Island 5048 through the underside of the housing and then flows through the device before exiting through the air grills on top of the housing.

When installing the device, a minimum clearance of 15 cm at the sides and 10 cm above the housing must be provided to ensure adequate ventilation of the Sunny Island 5048.

All external cables are connected through the underside of the housing. This requires a minimum clearance of at least 30 cm.

Operation of the device and reading the display is much easier when the Sunny Island 5048 is installed with the display at eye-level with at least 50 cm clearance in front.

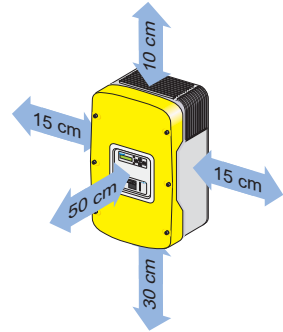

*When installing the Sunny Island 5048 in smaller rooms, make sure that adequate ventilation is available. The device produces heat when operating that must be removed.*



*Several Sunny Island 5048 inverters can be installed on top of each other without any problem, since the active OptiCool ventilation system dissipates the heat. The integrated fans are controlled in a temperature-dependent manner.*

### 4.1.4 Wall Mounting



**Do not install the Sunny Island 5048**

- on flammable construction materials,
- in areas where highly inflammable materials are stored,
- in potentially explosive areas!



**Because of possible condensation the Sunny Island 5048 may only be operated hanging vertically and not horizontally!**

The Sunny Island 5048 weighs 63 kg. Please take this weight into account when choosing the installation site and method of installation.

Protect the Sunny Island 5048 from direct sunlight. High temperatures lead to lower performance of the battery inverter.

The ambient temperature must not be outside the 25 °C to +50 °C range.



To make the job easier, we recommend using the supplied wall bracket to mount the Sunny Island 5048 and using a spirit level to ensure correct alignment. Secure the wall bracket with three screws (diameter of 8 mm).

The figure below shows in detail the distances of the holes to be drilled for mounting of the wall mounting bracket as well as the minimum clearance between two or several Sunny Island 5048 mounted. The two outer screws keep the Sunny Island 5048 attached to the wall.

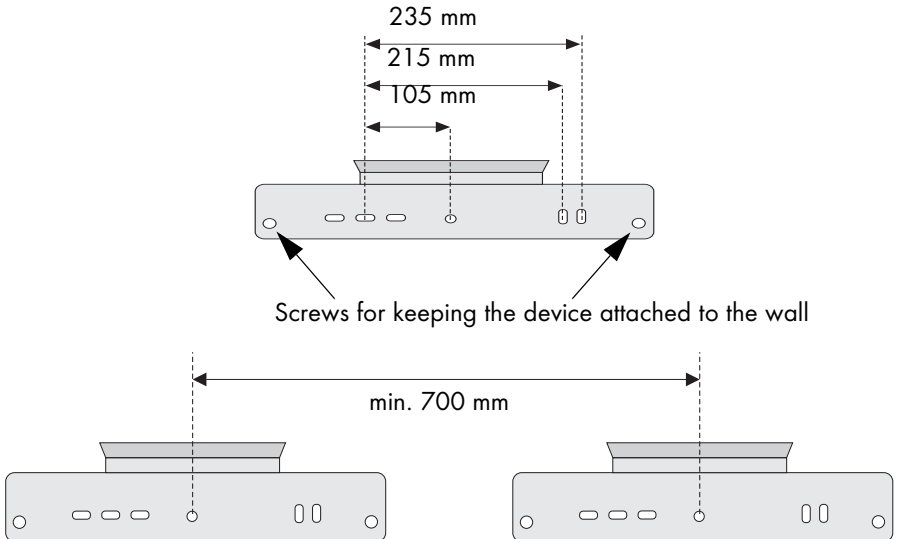
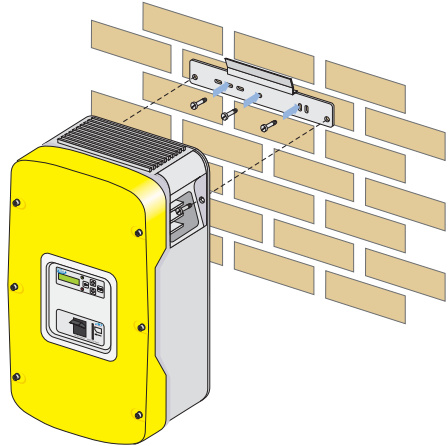

Keep to the order below when installing the Sunny Island 5048:

- Fit the wall bracket (1). In order to mark the positions for the drill holes, you can use the wall bracket as a drilling template.
- Now hook the Sunny Island 5048 onto the wall bracket at its mounting plate so that it cannot be moved sideways.

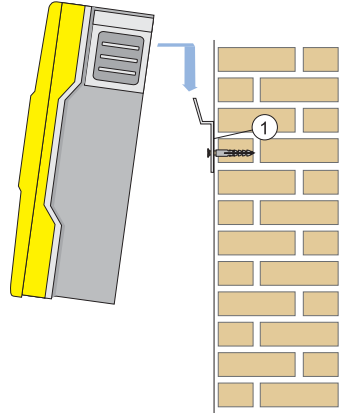

- Secure the Sunny Island 5048 against being raised by screwing on the wall bracket using the supplied bolts.

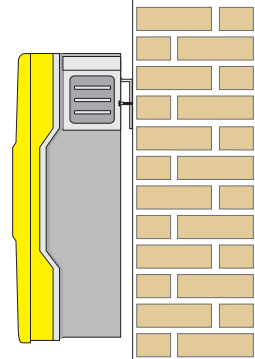

- Insert the ventilation grills on the right and left side on the upper part of the device (they snap in place).
- Make sure that the Sunny Island 5048 is positioned securely on the bracket.

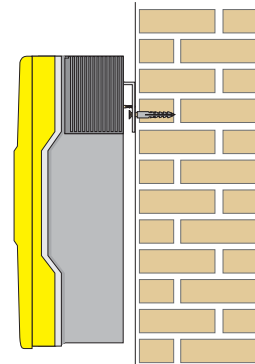

## 5 Opening and Closing

The housing of the Sunny Island 5048 has a removable cover. Remove this cover only when installing the device or for required maintenance or repair work.

**The Sunny Island 5048 may only be installed or opened by suitably qualified personnel (electricians).**



**Switch off the Sunny Island 5048 and disconnect all voltage sources (batteries, (stand-alone) grid, generator) (see section 9.2 "Stopping" (Page 62) and 9.3 "Switching Off" (Page 63)).**

**Wait five minutes.**

**Ensure that the system cannot be accidentally switched on again.**

### 5.1 Opening the Device

Proceed as follows:

1. Loosen the six hexagon socket screws on the front side of the Sunny Island 5048 in order to remove the cover.
2. Remove the six hexagon socket screws.
3. Carefully and evenly pull the housing cover until it comes free from the housing.
4. Store the plate in a safe place while mounting, installing or repairing the device.

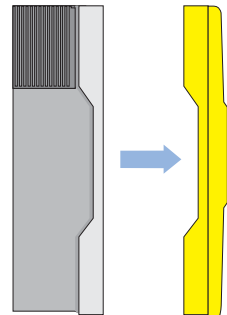

## 5.2 Closing the Device



When closing the Sunny Island 5048, make sure that the tooth lock washers are under the six hexagon socket screws. They secure the ground connection of the cover.

Before installing the housing cover of the Sunny Island 5048, ensure that all cables are properly laid and that all tools have been removed from within the housing (see section 6 "Electrical Connection" (Page 31)).

1. Starting from the front, place the cover evenly on the housing.
2. Fasten the housing cover to the Sunny Island 5048 with the six hexagon socket screws. Tighten the screws evenly and firmly.

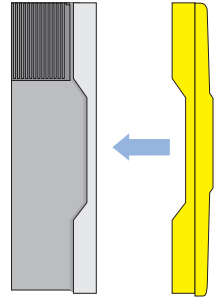

## 6 Electrical Connection

The electrical installation of the Sunny Island 5048 must be made by suitably qualified personnel only (qualified electrician). Before beginning to install your Sunny Island 5048, identify any potential hazards and take any necessary precautions (see section 3 "Safety Instructions" (Page 21)).



If the device is connected incorrectly, a significant danger of injury or death arises and damage to the device, system or plant may also result.



All cables are fed through the feed-throughs on the bottom side of the device (see following figure) and connected to the appropriate connection terminals inside the Sunny Island 5048.

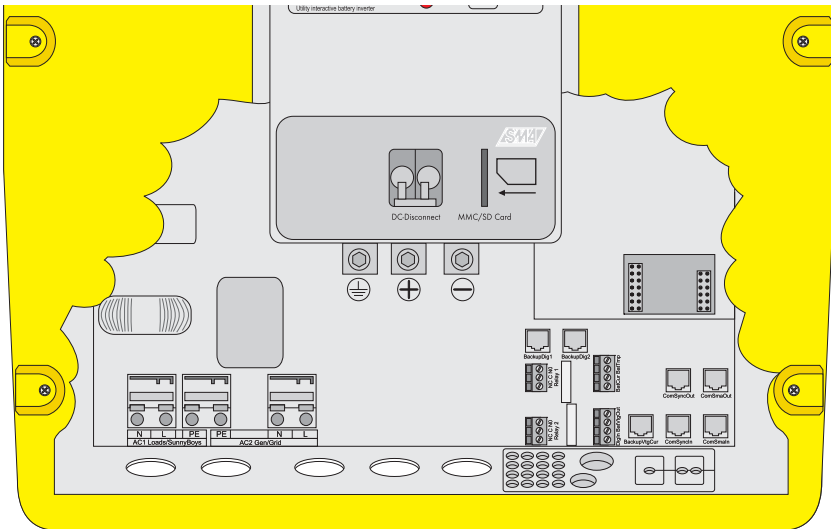

Use the metric-thread cable screw connections provided to fasten the cables inside the housing of the Sunny Island 5048 according to the appropriate standards. The metric-thread cable screw connections guarantee a dust-free and waterproof installation of the cables in the housing and also provide strain relief for the cable connection. Close all unused openings in the housing using the appropriate dummy plugs.

You can obtain an overview of the different components and connection areas of the Sunny Island 5048 by referring to the figure in 2.2 "At a Glance" (Page 15).

Detailed installation descriptions of the connections are provided in the following sections:

- Grounding (section 6.1)
- DC connection (section 6.2)
- AC connection (section 6.3)
- Battery temperature sensor (section 6.4.1)
- Battery current sensor (section 6.4.2)
- Communication multi-device connection (section 6.4.3)
- Multi-function relays 1 and 2 (section 6.4.4)
- External communication (section 6.5)

## 6.1 Grounding



*In stand-alone configurations, the (protective) ground of the Sunny Island 5048 and its individual components must be wired as TN grid. All valid standards and guidelines must be taken into account!*



**Before commissioning the Sunny Island 5048 it has to be properly externally grounded according to the relevant regulations.**

**To allow different types of grounding, the N connection of the Sunny Island 5048 is NOT connected to PE at the factory. However, since a connection between N and PE is required for correct operation, this must be done outside of the device.**

**Due to filter measures in the device, increased leakage currents against PE can occur during operation. For this reason, a "fixed connection" of ground must be implemented according to EN 50178. Ground the device with a copper conductor (at least 10 mm<sup>2</sup> cross-section), or with two separate copper conductors with a cross-section of at least 4 mm<sup>2</sup>, each.**



*External grounding of the negative pole of the batteries is possible, because the batteries and the grid side are galvanically isolated within the Sunny Island 5048. In this case, make sure that the high currents that may occur under fault conditions can be adequately diverted.*

*If a connection is required, this must be made by an installer externally.*

The DC grounding conductors must be connected to the terminal labeled as "Grounding". Installation of the grounding conductors is done in five steps:



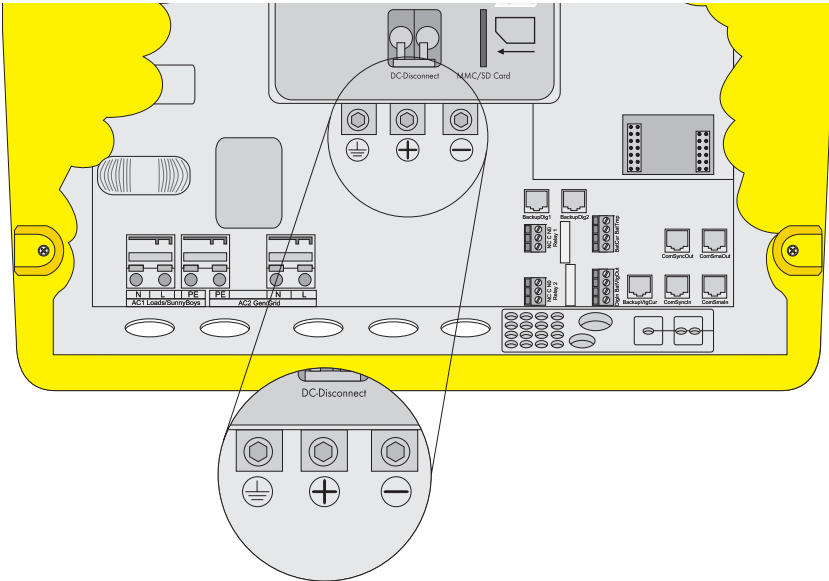

1. Loosen the cable screw connection on the device.
2. Pull the cable screw connection over the grounding conductor.
3. Remove the protective insulation from the conductor and fit a suitable ring cable lug to the exposed end of the conductor.
4. Install the cable screw connection with the adapter M32/M25 (included in delivery) in the cable second cable feed-through on the right.
  - Insert the metric-thread cable screw connection into the feed-through opening.
  - Screw the counter-nut onto the cable screw connection thread inside the housing and tighten it.
5. Insert the conductor with the ring cable lug into the ground connection terminal and tighten the screw firmly (torque 4.0 Nm to 5.7 Nm).

### Calculating the Required Grounding Conductor Cross-section

SMA Technologie AG cannot calculate generally valid values for the required cross-section of the grounding conductor for external grounding of the battery. The conductor dimensions depend on the type and size of the battery connected, the external fuse (DC side) and the material used in the grounding conductor.

*Exact calculation of the grounding conductor cross-section must take account of the regionally applicable standards and guidelines (e.g. DIN VDE 0100 Part 540).*



The required cross-section of a (copper) grounding conductor can be calculated using the following formula. Trigger times, e.g. for the integrated DC circuit breaker, of about 25 ms are typical for short circuit currents between 2000 A and 10,000 A.

$$S = \frac{\sqrt{I_{sc}^2 * t}}{143}$$

$t$  = disconnection time in seconds  
 $I_{sc}$  = max. battery current (short circuit) in Ampere  
 $S$  = cross section of the conductor in mm<sup>2</sup>

A grounding conductor with a cross-section of 16 mm<sup>2</sup> is thus adequate for short circuit currents up to 10,000 A.

## 6.2 DC Connection

### 6.2.1 Safety Precautions/Conditions

Connect a suitable battery to the DC side (see section 22 "Technical Data" (Page 175)). DC must be connected observing all valid regulations (e.g. DIN VDE0510, Rules for Accumulators and Battery Systems).



**All safety and maintenance instructions provided by the battery manufacturer must be heeded.**



**Use appropriate (insulated) tools for installation and wiring of the batteries (danger of short circuits and arcing).**



**When connecting the battery, ensure that the cable has sufficient cross-section and that the connections have the correct polarity.**



*The battery cables should be as short as possible. Long cables and an insufficient cable diameter reduce system efficiency and overload capability. Do not lay the battery feed cables under plaster or in armored plastic pipes. Large currents flow through the battery cables so that they can become very warm.*

## 6.2.2 Cable Protection

In addition to the DC circuit breakers within the Sunny Island 5048, install a separate fuse as close as possible to your batteries. Install a suitable fuse plug for the fuse according to the maximum specified DC current (e.g. NH1 at 250 A).

**If no cable protection exists, then the DC cables must be protected against ground faults and short circuits. The internal DC fuse of the Sunny Island 5048 is designed to interrupt currents of up to 10 kA.**



**For short circuit currents greater than 10.00 A an additional thermal fuse is absolutely essential ("SI-BattCase.01-250").**

## 6.2.3 Connection

**Only connect the external fuse/battery cables to the battery when all other installation work is finished.**



One "DC -" and one "DC +" are available in the Sunny Island 5048 (max.70 mm<sup>2</sup>) for connecting the battery.

Install the DC connections in the following sequence:

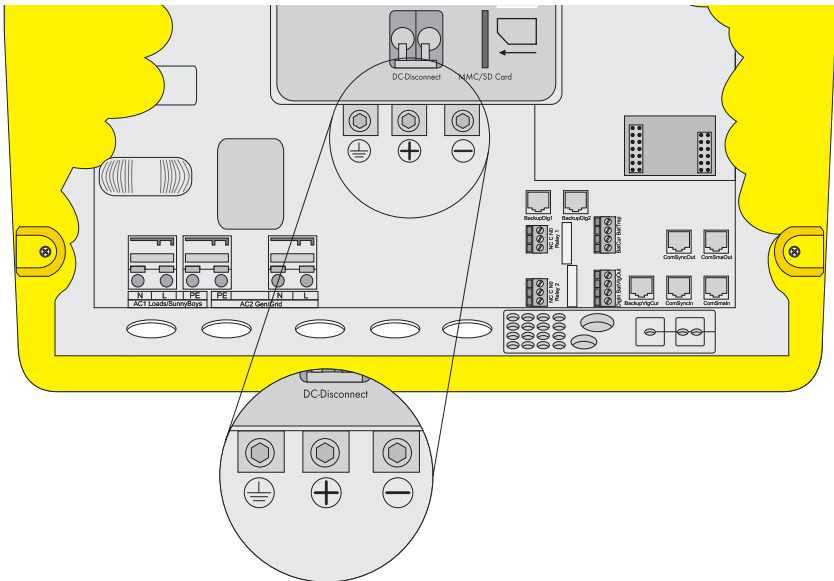

1. Loosen the cable screw connections at the device.

2. Pull the cable screw connections over the conductors.
3. Remove the protective insulation from every conductor and fit a suitable ring cable lug to the exposed end of the conductor.
4. Install the M25 cable screw connection (included in delivery) for "DC –" and "DC +" in the cable feed-throughs.
  - Insert the metric-thread cable screw connection into the opening in the feed-through.
  - Screw the counter-nut onto the cable screw connection thread inside the housing and tighten it firmly.
5. Insert the "DC –" conductor with the ring cable lug into the "DC –" connection terminal and tighten the screw firmly (torque 4.0 Nm to 5.7 Nm).
6. Insert the "DC +" conductor with the ring cable lug into the "DC –" connection terminal and tighten the screw firmly (torque 4.0 Nm to 5.7 Nm).



*No other components should be connected to the cables connecting the batteries with the DC connection of the Sunny Island 5048. Connection of other components should be done using separate cables leading directly to the batteries.*

## 6.3 AC Connection

### 6.3.1 Cable Protection

Use a sub-distribution unit in order to connect the Sunny Island 5048 to the stand-alone grid and external sources possibly available.



*The sub-distribution unit must be equipped with appropriate circuit breakers. Be sure to observe all the applicable regional standards and guidelines.*



*The maximum permissible current that may flow through the AC input of the Sunny Island 5048 is 56 A.*



*The Sunny Island 5048 has no all-pole isolation: The neutral conductor (N conductor) is looped through the device, i.e. the N connection terminals of AC1 and AC2 are connected inside the device.*

## 6.3.2 AC1 (Loads/Sunny Boys)

The stand-alone grid sub-distribution (e.g. loads, PV inverter (Sunny Boy), wind turbine (Windy-Boy)) is connected to the AC1 output of the Sunny Island 5048. If you wish to provide separate protection for an individual load circuit, then use a maximum 16 A, B-type circuit breaker. In the case of a short circuit, the Sunny Island 5048 can still trigger these types of automatic breakers:

*In case larger fuses are used or fuses that blow slower the Sunny Island 5048 cannot trip these. In these cases be sure to install a residual current breaker (RCD) in order to avoid dangerous body currents.*

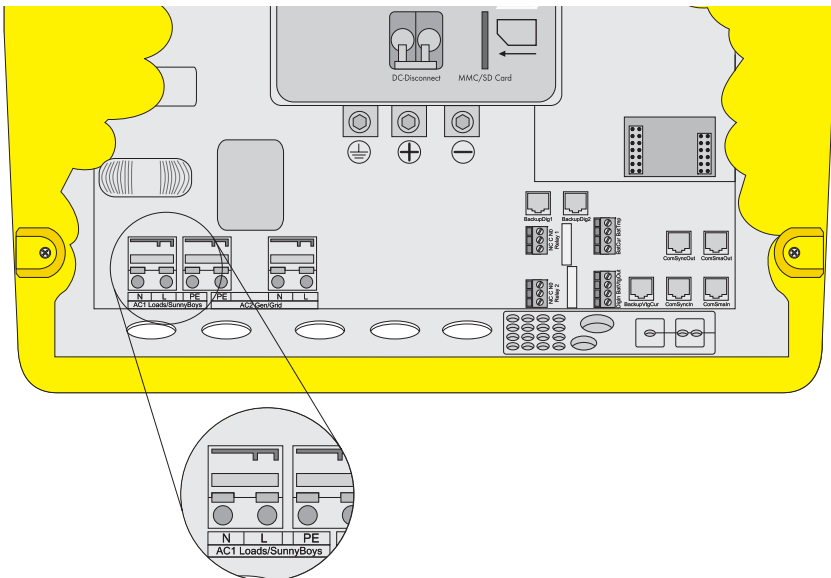

1. Pull the cable screw connection over the three-pole conductor and plug the conductor into the opening of the Sunny Island 5048.
2. Install the M25 metric-thread cable screw connection (included in delivery) in the "AC1 - Loads/Sunny Boys" cable feed-through.
  - Insert the cable screw connection into the opening in the feed-through.
  - Screw the counter-nut onto the cable screw connection thread inside the housing and tighten it firmly.
3. Remove the protective insulation from the three conductors.
4. Install the three PE, N and L wires at AC1: Insert the appropriate wire in the order mentioned into the appropriate PE, N or L "AC1 (Loads/Sunny Boys)" spring-type terminal.



**Connection in a parallel 1-phase system:**

Connect all parallel single-phase Sunny Island 5048 with the same cable cross-sections and cable lengths.



**Connection in a 3-phase system:**

Always install the master at phase L1, slave 1 at L2 and slave 2 at L3. This installation results in a right-hand rotary field.



If a phase fails within a three-phase grid, the cluster continues to run. In order to protect your loads, you may require phase monitoring or a motor overload switch.

### 6.3.3 AC2 (Generator/Grid)

The sub-distribution of the generator/public grid is connected to the output AC2 of the Sunny Island 5048. Wire AC2 in the following sequence:

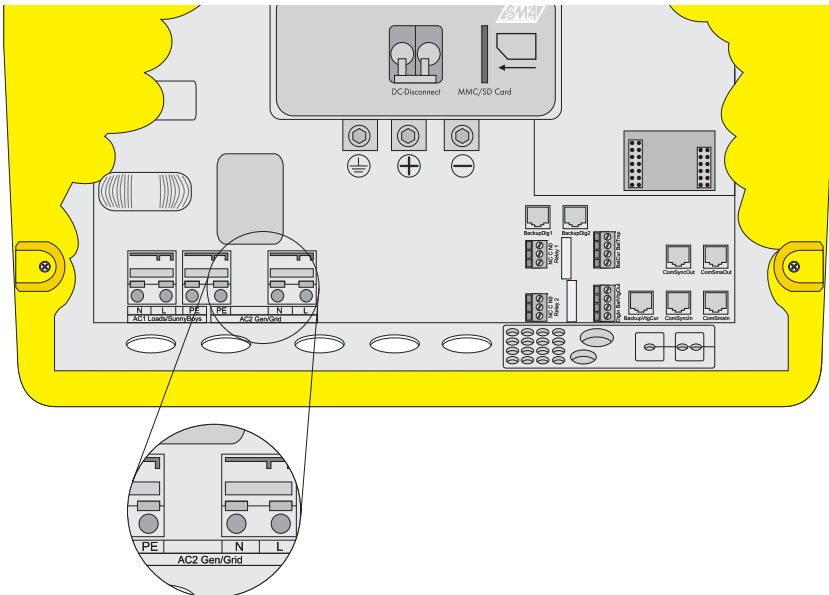

1. Pull the cable screw connection over the three-pole conductor and plug the conductor into the opening of the Sunny Island 5048.
2. Install the M25 metric-thread cable screw connection (included in delivery) in the "AC2 - Generator/Grid" cable feed-through.

- Insert the cable screw connection into the opening in the feed-through.
  - Screw the counter-nut onto the cable screw connection thread inside the housing and tighten it firmly.
3. Remove the protective insulation from the three conductors.
  4. Install the three PE, N and L wires at AC2: Insert the appropriate wire in the order mentioned into the appropriate PE, N or L "AC2 (Generator/Grid)" spring-type terminal.

**Parallel 1-phase system**

*In case of parallel 1-phase systems also connect the generator or the grid to all Slaves on AC2. The cable cross-sections and cable lengths used must be identical.*

**3-phase system**

*Always install the phase L1 on the master, L2 on slave 1 and L3 on slave 2.*



*The system does not monitor additional fuses. Check any additional fuses regularly!*



## 6.4 Additional Connections

For installing the connections described below, feed the cables through the specified holes in the rubber terminal block. Plugs for sealing the RJ45 communication cable for internal and external communication are provided in the rubber terminal block when delivered. Combining plugs allows to establish 0 to 4 feed-throughs (2 plugs without a feed-through, 1 with 1 feed-through and 2 with 2 feed-throughs). Remove them in order to connect the communication cable.

### 6.4.1 Battery Temperature Sensor

The battery temperature sensor measures the temperature of the connected battery. This is necessary since the optimum charging voltage for a battery largely depends on the temperature. Further information is provided in section 13.4 "Charge Control" (Page 96).



*A battery temperature sensor must be connected for operating the Sunny Island 5048 (included in delivery).*

*In case of a failure of the temperature sensor (short circuit, damaged cable) the Sunny Island 5048 operates in a safe setting which results in insufficient charge sequences of the battery. A warning is displayed, the damaged temperature sensor should be replaced immediately.*



**Only use the battery temperature sensor provided with the delivery.  
Do not drill any holes in the battery to mount the sensor.**



*Every Sunny Island 5048 is delivered with a battery temperature sensor enclosed.  
Only one battery temperature sensor connected to the respective master is required for a cluster.*

When connecting the battery temperature sensor proceed as follows:



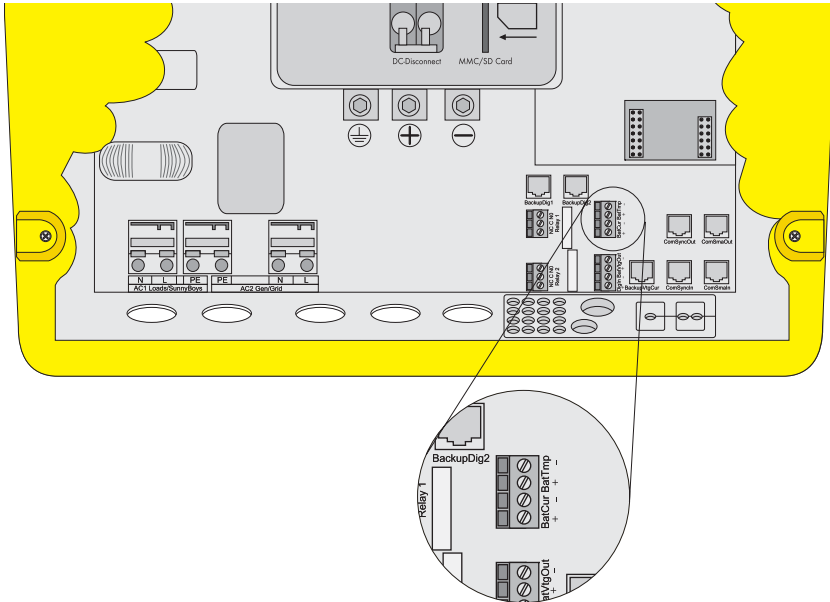

1. Pierce a hole in the rubber terminal area at the appropriate position.
2. Starting from the outside, feed the cable with the cable end sleeves through the hole.
3. Insert one wire each with the cable end sleeve into the "BatTmp" connection terminal of the 4-pole terminal included in delivery and tighten the terminal screws firmly.

*The polarity of the two wires is irrelevant for the functioning of the battery temperature sensor.*



4. Insert the 4-pole terminal into the "BatTmp" socket.

*Fasten the battery temperature sensor to the outside of one of the battery cells. Choose a position between two cells or at least in the middle of the battery bank, since the batteries generate the most heat in this region during operation.*



## 6.4.2 Battery Current Sensor

In addition to the internal measurement, the Sunny Island 5048 provides the possibility to measure the battery current via a shunt.

The battery current sensor is obligatory in case that DC generators and DC consumers shall be connected. Only one battery current sensor connected to the respective master is required for a cluster.



When connecting the battery current sensor proceed as follows:

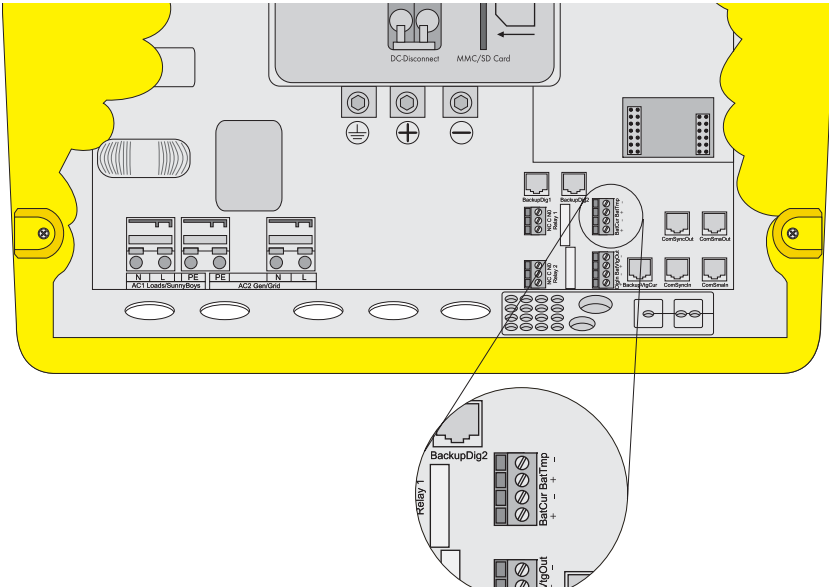

1. Pierce a hole in the rubber terminal area at the appropriate position.
2. Starting from the outside, feed the cable with the cable end sleeves through the hole.



The battery current sensor must be looped around the negative pole of the battery. The side of the shunt that is connected to the Sunny Island 5048 must be connected to the "BatCur+" connection terminal.

If the battery current sensor is connected as described above,

- positive battery current means that the battery is discharging (current from the battery)
- negative battery current means that the battery is charging (current into the battery)

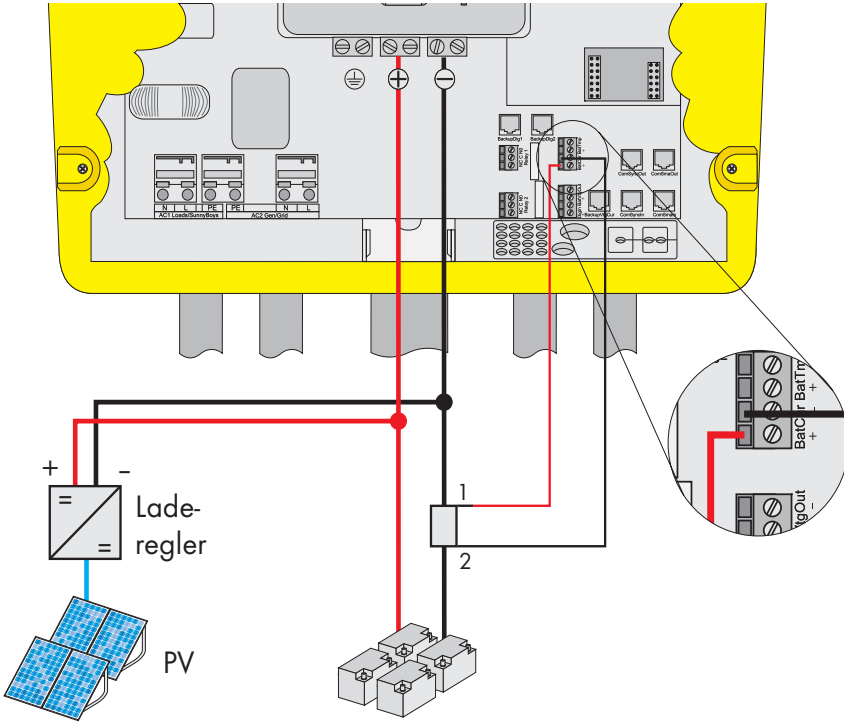

Charge controller and PV in the illustration above are only examples!



3. Insert one wire, each, with the cable end sleeve into the "BatCur" connection terminal of the 4-pole terminal included in delivery and tighten the terminal screws firmly.
4. Insert the 4-pole terminal into the "BatCur" socket.

Make sure to use intrinsically safe cables to connect the battery current sensor. "Intrinsically safe" means here that the cable is double-insulated and that the wire melts but the insulation remains intact in the event of a short circuit. In addition, the cable is not combustible. In order to avoid measuring errors, make sure to use twisted cables.



When connecting a battery current sensor to the Sunny Island 5048 the device-internal offset must be set. This is only possible when you are in the installer level and the Sunny Island 5048 is in standby mode.

Proceed as follows:

- Connect a short-circuit bridge (e. g. a piece of wire) to the "BatCur+" and "BatCur-" terminals instead of your battery current sensor.
- Use the "225.01 BatCurSnsTyp" parameter in order to set which type (None/50mV/60mV) you will use. After a sensor type has been set (50mV/60mV) other parameters (02, 03 and 04 in the menu "225# Battery Current Sensor) will be activated.
- Using the "225.02 BatCurGain60" and/or "225.03 BatCurGain50" parameter set the maximum current value of the battery current sensor used (e. g. 400A/60mV).
- Close and start the Sunny Island 5048 as described in the manual.
- Change to "225.04 BatCurAutoCal" and set "Start". The Sunny Island 5048 conducts an automatic calibration.
- Check the offset failure with the "120.06 TotBatCur" parameter. It should be (approximately) zero.
- Open the Sunny Island 5048. Remove the short-circuit bridge connected to the "BatCur+" and "BatCur-" terminals. Connect the battery current sensor instead of the short-circuit bridge.

### 6.4.3 Communication for Multi-Device Connection

Several Sunny Island 5048 can be connected in parallel or in a 3-phase system in order to increase the overall power. The devices communicate with each other via an RJ45 communication cable.

*The RJ45 communication cable is a usual UTP cable (Twisted Pair).*



*Each Sunny Island 5048 is delivered with a black RJ45 communication cable included.*



*It is required in order to establish an (internal) communication between several Sunny Island 5048. If you operate only one Sunny Island 5048 in the cluster the cable is not required.*

*Make sure that you have selected a multi-phase/parallel configuration according to the Quick Configuration Guide (see section 8 "(First) Commissioning" (Page 57)).*



Connect the communication cable as follows.

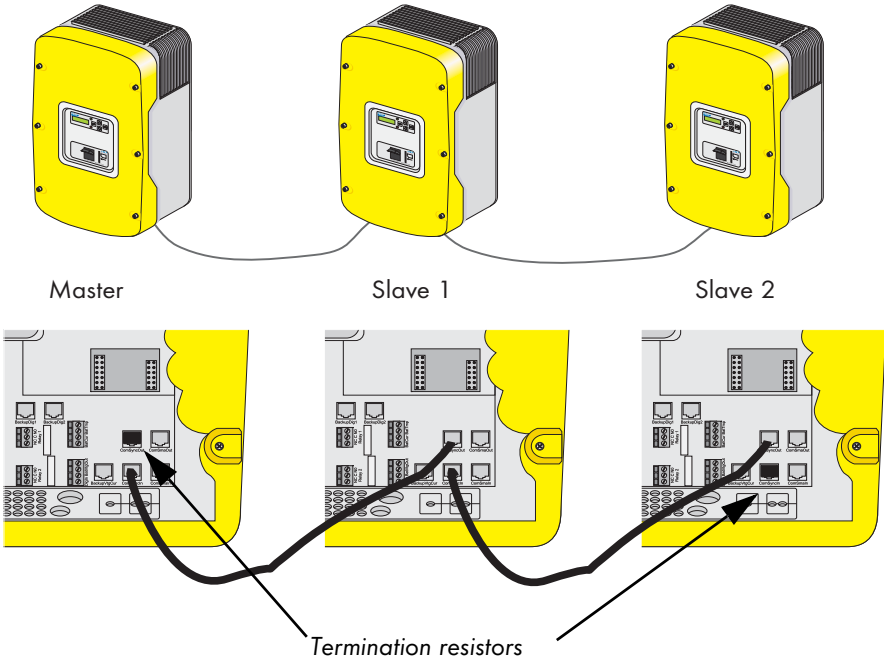

1. Remove the left one of the two plugs in the rubber terminal area.
2. Starting from the outside, feed the RJ45 cable through the hole.
3. Plug the RJ45 connector into the lower socket, the terminator connector remains in the upper socket.
4. The cable is plugged into the upper socket in the next Sunny Island 5048. Any other additional cable would be inserted into the lower socket and lead to the next Sunny Island 5048 (in the upper socket). Insert the terminator plug into the lower socket if there is no further Sunny Island 5048.
5. Wrap the rubber plug (with one or two feed-throughs according to number of cables) around the cable.
6. Reinsert the plug into the opening provided in the rubber terminal block.

## 6.4.4 Multi-function Relays 1 and 2

The Sunny Island 5048 lets you control internal and external processes. The device is equipped with two multi-function relays, that you can configure with menu 241# by using the parameters Rly1Op and Rly2Op (see section 15 "Relay" (Page 125).

*The relays have both open and close functionality.*

*All relay functions are designed to close, i.e. the contact is closed in case the relay is activated. The exception "Error" results from the fact that the relay opens when activated. This means that the relay is normally activated and opens the contact. Only in case of a failure it is deactivated and closes the contact (and thus e. g. activates a warning light).*

*You can only assign one function to the relay. In case of a cluster, the relays of the slaves are configured by the master.*

When connecting the relays proceed as follows:

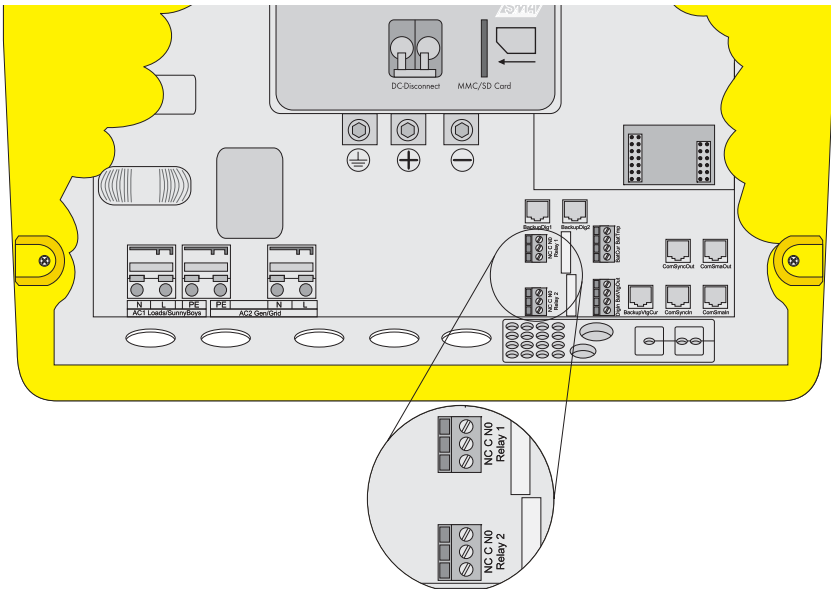

1. Pierce a hole in the rubber terminal area at the appropriate position.
2. Starting from the outside, feed the cable with the cable end sleeves through the hole.

3. Insert the wires with the cable end sleeve into the "Relay 1" or "Relay 2" connection terminal of the 3-pole terminal included in delivery and tighten the terminal screws firmly. The pins are defined as explained in the following:
  - NC: Normally closed (closed when idle)
  - C: Contact (operation contact)
  - NO: Normally opened (opened in standby)
4. Insert the 4-pole terminal into the appropriate socket.

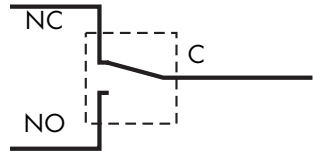

For logical reasons, the functions load shedding and generator request should be connected to the master, since, in case of a failure, the slave waits for acknowledgement while the master continues to operate and at least limited operation is possible.



*Information on the switching capacity of the relays is provided in section 22 "Technical Data" (Page 175).*

## Load Shedding

The Sunny Island 5048 can automatically switch off loads to protect the batteries from deep discharge. To do this, an external (AC or DC) power contactor must be installed between the Sunny Island 5048 and the loads (see also section 21.1 "Accessories (Optional)" (Page 173)).



**Installation of the load shedding system is strongly recommended in systems with extensive AC-side coupling of solar power or wind power. This is the only way to achieve safe operation of the system, even in cases of low energy generation or very high consumption.**

**Disconnect only the loads, never disconnect the generators (e. g. Sunny Boys)!**

## Generator Start

The Sunny Island 5048 can control generators which can be started/stopped using a single contact and generators requiring more than one contact (together with the optional generator manager (GenMan)).



This is done by the two freely programmable relay integrated in the Sunny Island 5048 (according to programming in the menu 241#, parameter Rly1Op and Rly2Op), see also section 15 "Relay" (Page 125).



The "AutoGn" function is pre-configured for Relay1 and the AutoLodSoc function for Relay2.

The first figure in section 2.1 "Properties" (Page 11) shows the principal connection.

## 6.4.5 BatVtgOut Power Supply

The battery voltage is conducted to the outside at these terminals. It is fused at both poles by PTC thermistors (max. 0.75 A) and can fluctuate depending on the battery status. This connection can, for example, be used to supply a DC contactor for load shedding.

Install the power supply as follows.

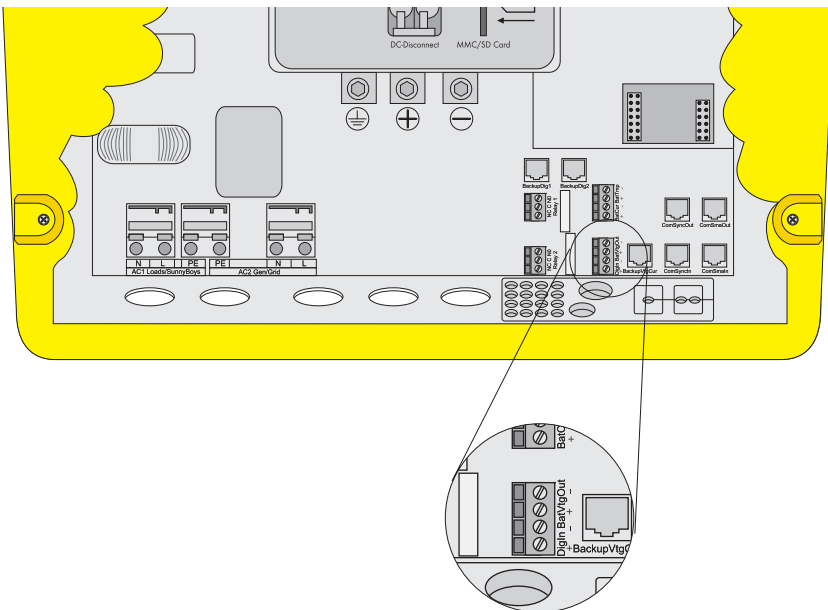

1. Pierce a hole in the rubber terminal area at the appropriate position.
2. Starting from the outside, feed the cable with the cable end sleeves through the hole.
3. Insert one wire each with the cable end sleeve into the "BatVtgOut" connection terminal of the 4-pole terminal included in delivery and tighten the terminal screws firmly.

4. Insert the 4-pole terminal into the "BatVtgOut" socket.

### 6.4.6 Digital Input DigIn

These terminals are used as digital inputs, e. g. the "Ready for operation" feedback contact for the GenMan (GenRn) is connected.



*In case you connect a GenMan operate the system with the generator and utility in parallel be sure to use the relay in the mater device in order to activate the according functions.*

Install the digital input as follows.

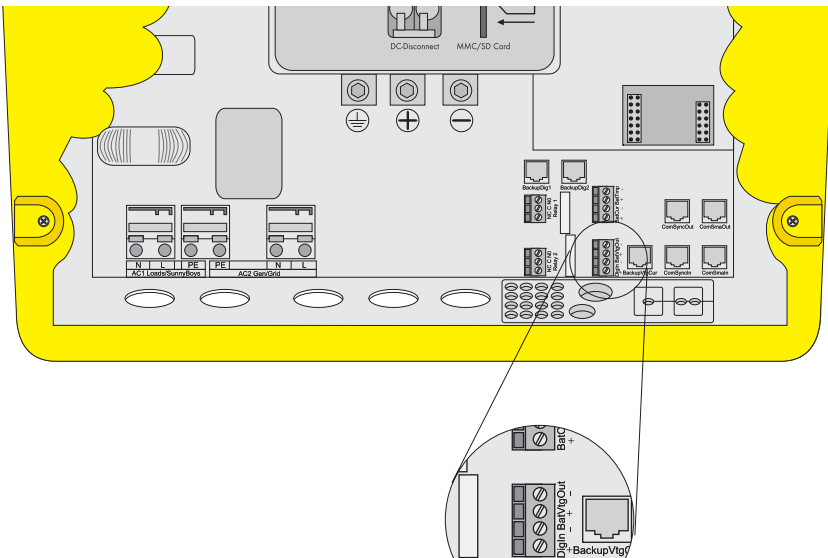

1. Pierce a hole in the rubber terminal area at the appropriate position.
2. Starting from the outside, feed the cable with the cable end sleeves through the hole.
3. Insert one wire, each, with the cable end sleeve into the "DigIn" connection terminal of the 4-pole terminal included in delivery and tighten the terminal screws firmly.
4. Insert the 4-pole terminal into the "DigIn" socket.



*For further information on connecting and operating the GenMan see the respective product documentation.*

## 6.5 Interface for External Communication

**Installation or replacement of the communication interface is only to be carried out by a trained electrician.**



The communication interface is used to communicate with SMA communication devices (e. g. Sunny WebBox) or a PC with appropriate software (e.g. Sunny Data). Depending on the selected communication interface, up to 50 inverters can be detected. Detailed information on this topic can be found in the communication device manual, the software, or on the Internet at [www.SMA.de](http://www.SMA.de).

The following communication interfaces can be integrated into the Sunny Island 5048:

- RS232
- RS485

*Piggy-backs are only required on the master device (Single Point of Operation).*



*Communication via Powerline/Powerline modem is not possible in island grids.*



The detailed wiring diagram for the individual communication interfaces can be found in the communication device manual. This wiring diagram includes the following information:

- Details on the required cable type
- Which of the inverter's connections are used
- Whether or not the communications cables must be terminated
- Whether the protective conductor needs to be connected to the cable shield

The next pages will describe the following:

- The housing feed-throughs for the communication interface
- The permitted cable route in the Sunny Island 5048
- The location of the screw terminals for connection of communication cables
- The location of the interface port

## 6.5.1 Connection of the Interface



**When opening the Sunny Island 5048, follow all the safety instructions as described in section 3.2 "Potential Hazards" (Page 22).**



*Electrostatic discharges are an acute danger to the Sunny Island 5048 and to the communication interface. Ground yourself by touching PE before removing the communication interface from the packaging, and before touching any components within the Sunny Island 5048.*



*Read the communication device manual before beginning installation work. Further wiring details can be found there.*

1. Remove the right one of the two plugs in the rubber terminal area.
2. Starting from the outside, thread the cable through the cable feed-through (A).
3. Plug the cable into the upper socket.
4. Put the plug around the cable.
5. Reinsert the plug into the opening provided in the rubber terminal block (A).
6. Lay the cables in the area (B), as shown in the following figure.
7. The 3 pins that you are supposed to use are specified in the operating manual for the communication device. The following table shows the assignment of the specified pins to the pins in the RJ45 socket.

Pin communication device (Sub-D 9-pin)	RS232	RS 485	RJ45 Socket
2	RXD	A (Data-)	1
3	TXD	B (Data+)	3
5	GND	GND	2

8. Terminating the Sunny Island 5048 at RS485. The RS485 data bus of the Sunny Island 5048 is terminated with a plug. This plug is shipped with your Sunny Island 5048. Remove this plug only when you intend to connect a further Sunny Island 5048 or a communication device.



*A red slide switch (C) allowing to change from RS485 to RS232 communication is positioned on the board above the RJ45 plug. Default setting is RS485 (position down).*

9. Plug the communication interface into the board (D).

10. Close the Sunny Island 5048 as described in section 5.2 "Closing the Device" (Page 30).

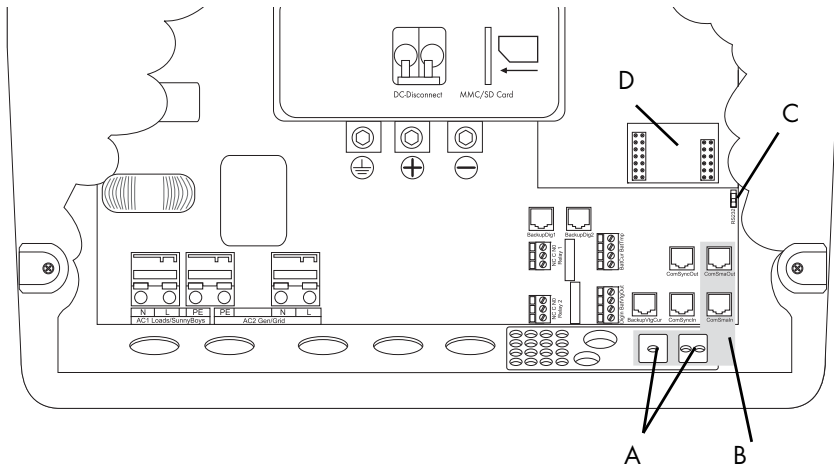

- A Housing feed-throughs in the base of the Sunny Island 5048
- B Cable route (gray surface)
- C Slide switch RS232 communication
- D Interface port

## 6.5.2 Data Transmission Rate

The Sunny Island 5048 can communicate with external devices at a range of different data transmission rates (1200 to 19200bps). The "250.06 ComBaud" parameter must be set appropriately for this.

*If Sunny Boys are connected to the communication bus, the baud rate must be set to 1200 bps (factory setting). For all other devices refer to the manufacturer's specifications.*



The Sunny Island 5048 uses the SMA-Net protocol for communication.

A detailed wiring diagram for the communication interfaces for the entire communications structure of your system can be found in the manual for the communication device you have chosen.



# 7 Control Elements

It is recommended that you make yourself familiar with the operation of the Sunny Island 5048 before you install it. The individual control elements can be seen in the figure below.

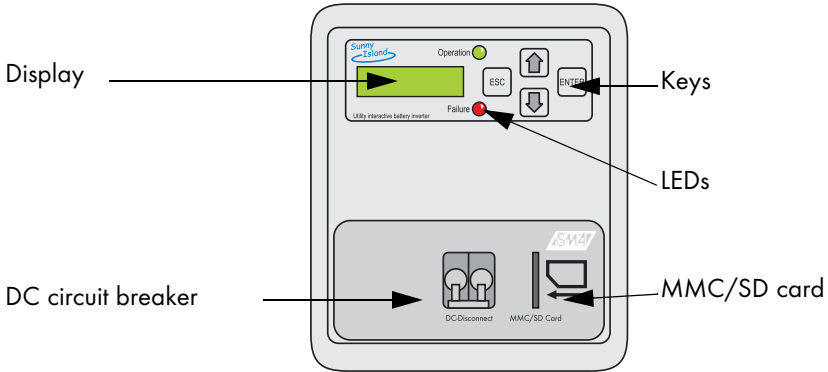

## 7.1 Display Messages

The display of the Sunny Island 5048 consists of two lines with 16 characters each. For details, refer to section 10.6 "Display Messages (Overview)" (Page 75).

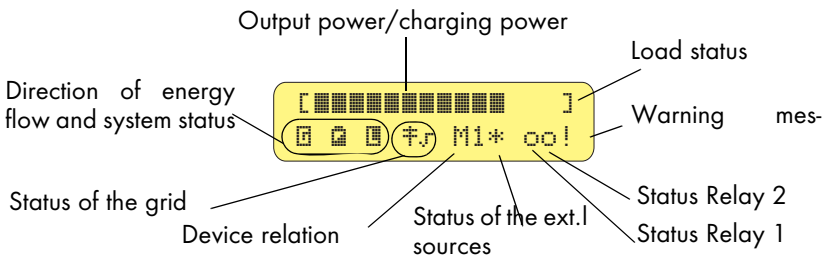





## 7.2 DC Circuit Breaker

The DC circuit breaker is used to switch on/off and to disconnect the Sunny Island 5048 on the DC side. For details, see section 9 "Switching On and Off" (Page 61).

## 7.3 Keys

The following table explains the key functions of the Sunny Island 5048:

Key	Functions
	<ul style="list-style-type: none"> <li>cancels the selected function</li> <li>answers NO</li> <li>navigates one menu level higher</li> </ul>
	<ul style="list-style-type: none"> <li>navigates up one list element</li> <li>increases data value</li> </ul>
	<ul style="list-style-type: none"> <li>navigates down one list element</li> <li>decreases data value</li> </ul>
	<ul style="list-style-type: none"> <li>selects a function</li> <li>selects a value</li> <li>confirms a change</li> <li>answers YES</li> <li>navigates one menu level lower</li> <li>starts device (when pressing longer)</li> <li>stops device (when pressing longer)</li> </ul>

## 7.4 Explanation of the Light-emitting Diodes (LEDs)

One red and one green light emitting diode (LED) is available on the front panel of the Sunny Island 5048, the function is described in the following table:

Green LED	Red LED	Operating mode
–	–	standby or off (no inverter operation)
ON	–	operation
–	ON	disturbance or failure
ON	ON	initialization

## 7.5 MMC/SD Card

The Sunny Island 5048 provides an MMC/SD card for firmware updates and as service interface. For details, refer to section 11 "Saving Data on an MMC/SD Card" (Page 81).



## 8 (First) Commissioning

### 8.1 Requirements

Before starting the commissioning process, ensure that all electrical connections have the correct polarity and make sure that everything is connected according to the instructions in section 6 "Electrical Connection" (Page 31).



Always use the MMC/SD card for saving data and events. In case of a failure SMA Technologie AG can thus quickly help you.



The Quick Configuration Guide (QCG) allows you to quickly install and commission your Sunny Island 5048. Select the system that "fits" best, the display then shows special requests that lets you explicitly modify according parameters of the respective system.

### 8.2 Starting the Quick Configuration Guide (QCG)

When starting the QCG, useful parameter values are set by default!



The QCG is automatically activated when the device is started for the **first** time.

1. Switch on the Sunny Island 5048 by switching the DC circuit breaker to the "ON" position.
2. The Sunny Island 5048 initiates the startup phase. Wait for the following displays to finish.

SIBFSBOOT V 1.00

SMA SMA SMA SMA

SMA SMA SMA SMA

SI5048

@SMA 2006

When starting the Sunny Island 5048 for the first time, the QCG is automatically activated. Continue reading under point 6. Otherwise, follow the listing below.



3. "To init system hold <Enter>" is displayed after the start-up phase.
 

**To init system  
hold <Enter>**
  
4. Press and hold <Enter> until the Sunny Island 5048 beeps three times.
5. You are now in the Quick Configuration Guide (QCG). You can select:
 

**01#StartMenu  
New System     ↵**

  - **"Start System"** (in case you are in the QCG by mistake and only want to restart)
  - **"New System"** (in case you want to commission a new system or make changes of the plant configuration)
  - **"New Battery"** (in case you want to change the main battery settings but to keep the system configuration)
  - **"Emerg Charge"** (in case you want to charge a deeply discharged battery, see section 20.9 "Troubleshooting" (Page 166))
  
6. The following parameters must be set for **"New System"**:
  - Device type: Master, Slave1, Slave2, Slave3
  - System configuration (selection see "Overview of System Configurations:" (Page 59)), presetting is "1phase 1SI"
  - Voltage/frequency type (230V\_50Hz, 220V\_60Hz), presetting is "230V\_50Hz"
  - Date
  - Time
  - Battery type (VRLA,FLA,NiCd), presetting is "VRLA"
  - Nominal battery voltage (44 to 48 V in 2-V steps for FLA and VRLA, 43.2 V to 48 V in 1.2-V steps for NiCd), presetting is "48.0 V"
  - Nominal battery capacity (100 to 10000 Ah), presetting is "100 Ah"
  - External power supply unit (PvOnly, Gen, Grid, GenmGrid)
  - Maximum generator current (0 to 224 A), presetting is "16 A"
  - Generator interface (Manual, GenMan, Autostart), presetting is "Manual"
  - Maximum grid current (0 to 224 A), presetting is "16 A"

The following parameters must be set for **"New Battery"**:

  - Battery type (VRLA,FLA,NiCd), presetting is "VRLA"
  - Nominal battery capacity (100 to 10000 Ah), presetting is "100 Ah"
  - Nominal battery voltage (44 to 48 V), presetting is "48.0 V"

## Overview of System Configurations:

Displayed Text	Meaning
1phase 1SI	1-phase system, 1 Sunny Island 5048
1phase 2SI	1-phase system, 2 Sunny Island 5048
1phase 3SI	1-phases system, 3 Sunny Island 5048
1phase 4SI	1-phase system, 4 Sunny Island 5048
Three 3SI	3-phase system, 3 Sunny Island 5048

In case of a system with more than one Sunny Island 5048, it is required to run the QCG on the slave(s) **before** starting the master device ("INIT MASTER OK START?" is shown in the display). The device type is set. Do not start the master device beforehand!



The option "New Battery" only resets specific battery relevant parameters. The overall system settings are not affected.



7. After the parameters indicated below have been entered the following message is displayed on the master:

```
INIT MASTER OK
START?      ↵
```

8. Press the <ENTER> key for confirmation. The following message is shown in the display.

```
STNDBY:To Start
INV hold <ENTER>
```

9. Press and hold the <ENTER> key. A beep is sent, the Sunny Island 5048 starts and is in operation.

In case only one Sunny Island 5048 is used in your system, the device type is set to "Master" and is not displayed.



If the device displays an error message contrary to expectations, this error must be fixed before the device can be put into operation. Use the information in section 20 "Troubleshooting/Problem Solving" (Page 157).





Details concerning the parameters are available in section 19 "Parameter Lists" (Page 133).

Note that you must first enter the installer password (see section 10.5 "Entering the Installer Password" (Page 74)) and that the device must be in standby mode (see section 9.2 "Stopping" (Page 62)) before some parameters can be changed.



For detailed parameter lists for your system contact the Sunny Island Hotline by email [SunnyIsland.hotline@SMA.de](mailto:SunnyIsland.hotline@SMA.de) or at (+49) 561 95 22 - 39.

The following information will help our employees in generating a parameter list for your system. Have this information available when you call:

- Type of inverter (Sunny Island 5048, see type plate)
- Type of voltage/frequency
- Serial number (see type plate or parameter "331.03 SN")
- Firmware version (see parameter "331.02 FwVer")
- Error message shown on the display
- Battery type
- Nominal battery capacity
- Nominal battery voltage
- Communication products used
- Type and size of additional energy sources (generators, PV systems, PV inverters)
- If a generator exists:
  - Generator type
  - Generator capacity
  - Max. generator current
  - Generator interface

# 9 Switching On and Off

## 9.1 Switching On/Starting

This step assumes that the Sunny Island 5048 has been checked for

- correct electric connections,
- voltages and polarities



and has already previously been put into operation by a qualified electrician.

1. Switch on the Sunny Island 5048 by switching the DC circuit breaker to the "ON" position.
2. The Sunny Island 5048 initiates the startup phase. Wait for the following displays to finish.

```
SIBFSBOOT V 1.00
```

```
SMA SMA SMA SMA
SMA SMA SMA SMA
```

```
SI5048
@SMA 2006
```

"To init system hold <Enter>" " is displayed after the startup phase.

```
To init system
hold <Enter>
```

3. If you want to open the QCG press and hold <Enter> until the Sunny Island 5048 beeps three times. The following display appears (for the further procedure see section 8.2 "Starting the Quick Configuration Guide (QCG)" (Page 57)).
4. If you do **not** press the <ENTER> key within 5 seconds the Sunny Island 5048 skips the QCG and the following display appears.

```
01#StartMenu
New System ↵
```

```
STNDBY:To Start
INV hold <ENTER>
```

Start the slaves, **before** starting the master device.



- The following message is displayed on the slaves after they have been started.

```
STNDBY:To Start
INV hold <ENTER>
```

- Press and hold the <ENTER> key, the remaining time is shown as bar on the display.

```
Hold to start...
■■■■■■■■■■
```

- The following display appears (until the master is started).

```
Ready
Wait for Master
```



*Even if the "250.01 AutoStr" parameter is set, the Sunny Island 5048 must be manually started once, each time the DC circuit breaker is started.*

- Press the <ENTER> key on the master. A beep is sent, the Sunny Island 5048 starts and is in operation. The green (upper) LED is illuminated.



*If the device displays an error message contrary to expectations, this error must be fixed before the device can be put into operation. Use the information in section 20 "Troubleshooting/Problem Solving" (Page 157).*

## 9.2 Stopping

Proceed as follows to set the Sunny Island 5048 in standby mode:



**Note that all connected loads are no longer provided with electrical energy once you have stopped the Sunny Island 5048.**

- Switch off all loads, as far as this is possible.
- Press the <ENTER> key in order to stop the Sunny Island 5048. The following display appears.

```
Hold to stop...
■■■■■■■■■■■■■■■■■■■■
```

- Press and hold the <ENTER> key, the remaining time is shown as bar on the display.

```
Hold to stop...
■■■■■■■■■■
```

- The Sunny Island 5048 has been stopped and the following display appears.

```
STNDBY:To Start
INV hold <ENTER>
```

**Note that even in standby mode there is still voltage present in the device (DC, AC1, AC2).**



*In standby mode the Sunny Island 5048 still requires about 4 W of power from the batteries.*



## 9.3 Switching Off

To switch off the Sunny Island 5048, proceed as follows:

1. Set the Sunny Island 5048 to standby mode (see section 9.2 „Stopping“ (page 62)).
2. Switch the DC circuit breaker of the Sunny Island 5048 to the "OFF" position.

*Deactivating the system with this procedure ensures that no data of the internal data acquisition is lost.*



*You must wait at least 30 seconds before reactivating the device, otherwise proper operation of the Sunny Island 5048 cannot be guaranteed.*



## 9.4 Disconnecting the Device from Voltage Sources

1. Switch off the Sunny Island 5048 (see section 9.3 „Switching Off“ (page 63)).
2. Disconnect the Sunny Island 5048 from the batteries.
3. Disconnect the Sunny Island 5048 from all voltage sources (remove all voltages from AC1 and AC2 and disconnect).
4. Make sure that the Sunny Island 5048 has been disconnected from all voltage sources.
5. Wait at least five minutes to let the capacitors discharge and allow the voltage inside the device to drop to a safe level.
6. The Sunny Island 5048 is now completely free of voltage and it can be opened.

## 9.5 Restarting the System after Automatic Shutdown



**A complete shutdown indicates that components of the stand-alone grid have failed or are not working correctly due to incorrect parameter settings. Check the components of the stand-alone system for possible failures, both before and after restarting the system, to avoid future complete shutdowns.**

To restart the Sunny Island 5048 after it has been switched off due to batteries that are too deeply discharged, proceed as follows:

1. Switch off the DC circuit breaker.



**You must wait at least one minute to allow the capacitors to completely discharge before switching the DC circuit breaker on again.**

2. After waiting one minute switch on the Sunny Island 5048 by switching the DC circuit breaker to the "ON" position.



*If, in rare cases, it is not possible to restart after one minute, wait a little longer and retry. A possible cause can be component tolerances.*

3. Proceed as described in 9.1 "Switching On/Starting" (Page 61).



*Once the system has been reactivated, it is important that the batteries are charged. If an autostart generator exists in the stand-alone grid, the Sunny Island 5048 will start the generator after a few minutes.*

4. Monitor the starting of the generator and check if the connection of the Sunny Island 5048 changes to charge mode.
5. Check that all other energy generators in your system are also working correctly.



*If the Sunny Island 5048 enters the battery preserve mode immediately after restarting (see section 13.5 "Battery Preservation Mode" (Page 100)), disconnect all consumers from the AC output (AC1 and AC2).*

*The loads can be reconnected once the Sunny Island 5048 enters the charge mode. A precondition for this is that a generator capable of providing the required power is connected*

*For more information refer to section 20.10 "Procedure During Emergency Charge Mode" (Page 169).*



**Installation of the load shedding system is strongly recommended in systems with extensive AC-side coupling of solar power or wind power. This is the only way to achieve safe operation of the system, even in cases of low energy generation or very high consumption.**



**Disconnect only the loads, never disconnect the generators (e. g. Sunny Boys)!**

**Also refer to "Load Shedding" in section 6.4.4 "Multi-function Relays 1 and 2" (Page 47).**



# 10 Operation

The main menu consists of a "Home Screen" and the main menu entries, which split up into the different menu levels. The "Home Screen" displays operating states, e. g. the current operating mode, power, etc. (see section 10.6 "Display Messages (Overview)" (Page 75)).

The menu consists of a main menu and up to two additional levels (further information is available in section 10.1 "Menu Structure" (Page 68)).

Use the up/down arrow keys in order to navigate through the menu levels. The cyclic arrangement allows to scroll forwards as well as backwards, which lets you reach the desired menu quickly.

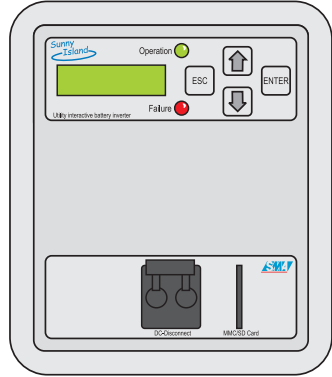

In order to reach the menu "7", go backwards from "1" over "9" instead of going six steps forwards.



When the desired menu is reached press the <ENTER> key in order to activate it. Use the <ESC> key to exit the menu and navigate one menu level up.

*Menu entries can be skipped. This depends on the password level. All parameters only available for the installer are skipped in the user level. The menu numbers are static, i.e. they do not change when one or several menu entries are skipped.*



*In case no key is pressed for 5 minutes the system automatically returns to the "Home Screen".*



*The background illumination is automatically deactivated after a short time of inactivity. Pressing one of the four cursor keys reactivates the background illumination. Pressing a cursor key with a deactivated background illumination has no effect except for the activation of the illumination.*



*The beeper is activated by default. Set parameter "270.04 BeepEna" to "Off" in order to deactivate it.*



Slave devices must wait for the commands from the mater device. In this time the following message is shown in the display.

```
Ready
Wait for Master
```

The Sunny Island 5048 uses the **"Single Point of Operation"** concept. In case of a system with more than one device all entries are made on the master. The complete system is configured, events, warnings and failures are confirmed and, if required, the firmware is updated (see section 11.6 "Firmware Update" (Page 86)) in the QCG (see section 8 "(First) Commissioning" (Page 57)).

**Exception:** When starting the device for the first time, you must set the slave devices as slave in the QCG and everything else is performed at the master.



Single Point of Operation also means that all data, including the slave data, must be saved on the MMC/SC card of the Master device.



Messages can always be displayed during operation, they have priority over the display of the "Home Screen".

## 10.1 Menu Structure



**Configuration and changes to system parameters may only be performed by suitably qualified personnel (electricians).**

The menu structure is divided into two levels:

- User Level
- Installer Level

The menus allowing system parameters to be changed can only be reached after entering the installer password (see section 10.5 "Entering the Installer Password" (Page 74)). These menu parameters can be used to monitor and control the Sunny Island 5048 in normal daily operation.

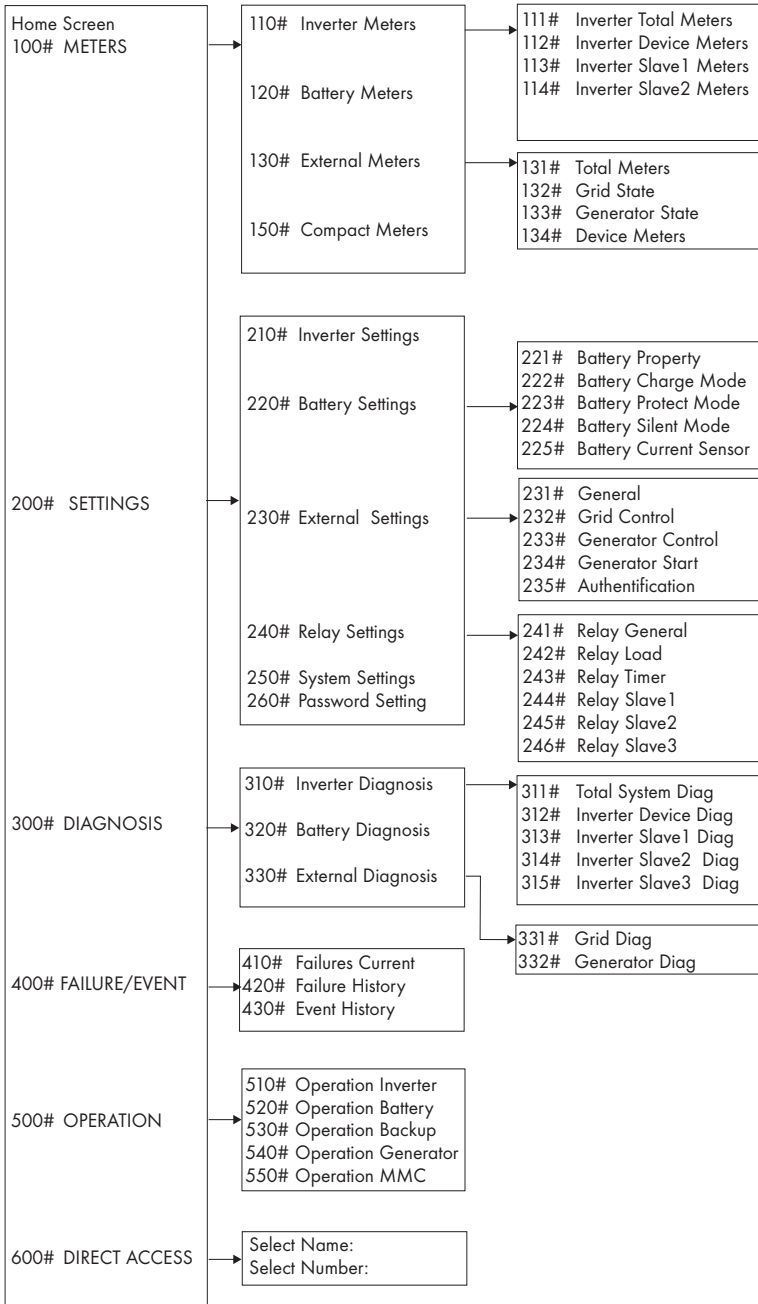

The menu structure is further divided into five different main menus with appropriate sub-menus.

**Display values (Meters):** The main menu "100# Meters" displays the most important display values in the first submenu:

- Sunny Island 5048 ("#110 Inverter Meters"),
- Battery ("#120 Battery Meters"),
- External sources ("#130 External Meters"),
- Compact displays ("#150 Compact Meters").

The second level consists of further submenus or single parameters (e.g. "#120.02 BatVtg" parameter).

**Settings:** Under the main menu "#200 Settings" different submenus allowing various system parameters to be viewed and changed are available.

- Sunny Island 5048 ("#210 Inverter Settings"),
- Battery ("#220 Battery Settings"),
- External sources ("#230 External Settings"),
- Relay ("#240 Relay Settings"),
- System ("#250 System Settings"),
- Password entry ("#260 Passwort Setting").

**Diagnosis:** Under the main menu "#300-Diagnosis" several submenus with the respective parameters are available.

- Device data ("#310 Inverter Diagnosis")
- Battery data ("#320 Battery Diagnosis")
- System data External sources ("#330 External Diagnosis")

**Lists (History):** Under the main menu "#400 History" several submenus with the respective lists are available:

- Current failures ("#410 Failures Current")
- Warnings and failures ("#420 Failure History")
- Events ("#430 Event History")

**Functions in operation:** Under the main menu "#500 Operation" several submenus with the respective parameters are available:

- Inverter ("#510 Operation Inverter"),
- Battery ("#520 Operation Battery"),
- External sources ("#530 Operation External"),
- Generator ("#540 Operation Generator"),
- MMC/SD card ("#550 Operation MMC").

**Direct Access:** Under the menu "600# Direct Access" settings and display values can be directly accessed.

## 10.2 Changing Parameters

The "up/down" keys let you move through the selected menu (see illustration in section 10.1 "Menu Structure" (Page 68)) in order to see or change a parameter. As soon as the desired parameter appears in the display, you can read the current parameter value.

An arrow  $\leftarrow$  next to the value indicates that the parameter can be changed.

If you press the <ENTER> key, the arrow begins to blink and you can use the "arrow up/down" keys in order to change the current parameter value.

*The rate of change (speed) increases the longer you keep the arrow key pressed.*



As soon as the desired value appears in the display, press the <ENTER> key to save the new value.

Select Y(es) or N(o) with the "arrow up/down" keys in order to accept the new value or reflect the change.

Finally press "<ENTER>" again in order to finish the process and continue with other modifications.

*Note that some parameters can only be changed in standby mode (see section 9.2 "Stopping" (Page 62)). The parameters which are affected by this are listed in the tables in section 19.2 "Adjustable System Parameters" (Page 139) and 19.5 "Function in Operation" (Page 155).*



In case of parameters which may only be changed in standby mode or require a different password, the Sunny Island 5048 will indicate this.

Display	Meaning
No permission to change the value	Incorrect password, you cannot make any changes in the menus. This is explained in section 10.5 "Entering the Installer Password" (Page 74).
Stop device to change the value	This parameter can only be changed in standby mode. Stop the Sunny Island 5048 in order to change the parameter (see section 9.2 "Stopping" (Page 62)).

### 10.3 Direct Access

Under the menu "600# Direct Access" it is possible to directly access selected parameters via the name or all parameters via the number.

Under the submenu "Select Name" the following function can be directly accessed:

- ManChrgSel: manual starting of equalization charge (see section 13.4.3 "Equalization Charge" (Page 99))
- GnManStr: manual starting of the generator (see section 14.1.4 "Manual Generator Operation" (Page 108))

Under the menu "Select Number" each parameter can be directly accessed by entering the parameter number.



You can e. g. select the "222.01 BatChrgCur-Max" parameter via the menu 600# in order to set the maximum battery charging current.

Direct access must be entered as five-digit number, e. g. 24101. The first three digits indicate the menu number and the last two digits the parameter number.

After the parameter has been successfully set exit the setup. By pressing the <ESC> key you return to Direct Access and can make additional changes.

### 10.4 Compact Meters

The Sunny Island 5048 shows max. four values in this special menu. This menu is especially to be used by the installer during the commissioning. Seven different compact meters are available.



The different displays of the compact meters can be scrolled with the up and down keys . The cyclic display is available here.

The displays are always shown from top left to bottom right.

#### Bat1 (Battery Values 1)

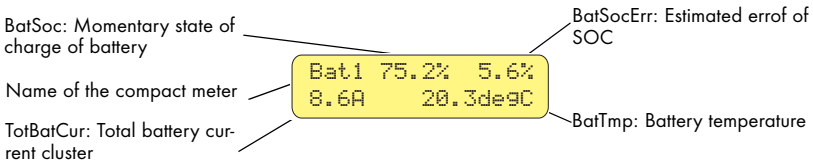



### Bat2 (Battery Values 2)

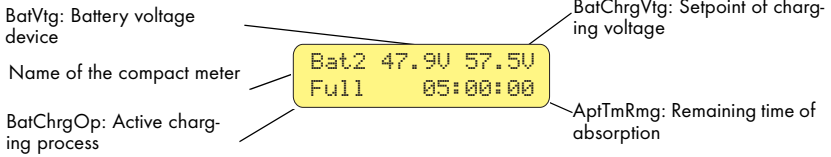

### Inv (AC Values of Inverter)

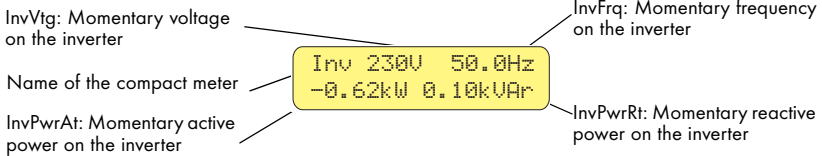

### InvTot (Total AC Values of Inverter)

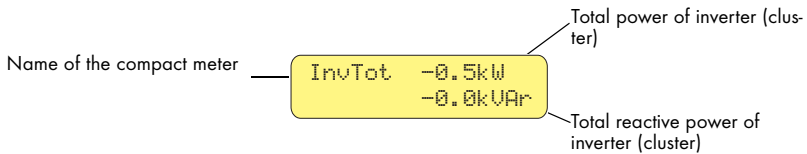

### Ext (AC Values of External Source)

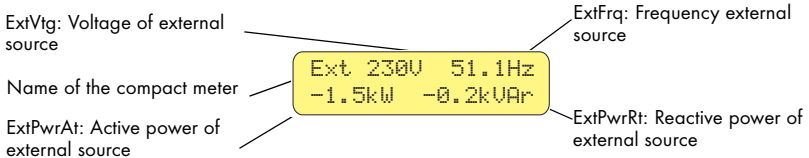

### ExtTot (Total AC Values of External Source)

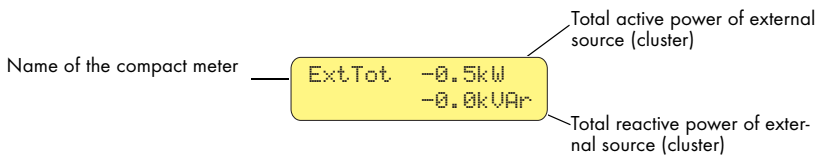

## OpStt (Inverter and Generator Status)

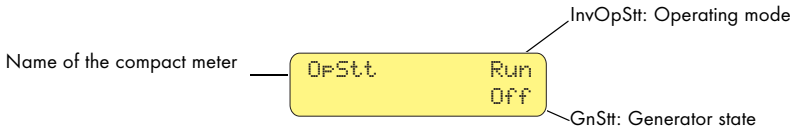

## 10.5 Entering the Installer Password



All parameters of the Sunny Island 5048 that have effect on the safety of the off-grid system are protected by the installer password.

These parameters may only be changed by suitably qualified personnel (electricians).



Do not provide the following information for calculation and entry of the installer password to unauthorized persons. Illegal provision of this information to other persons will lead to invalidation of all guarantee provisions of SMA Technologie AG.



*In case of the Sunny Island 5048 the password can be entered when the system is in standby mode or in normal operation.*

The password required for access to all "Installer Level" parameters (see figure in section 10.1 "Menu Structure" (Page 68)) depends on the operating-hours counter.

Proceed as follows to calculate and enter the installer password:

1. You are in "Home Screen". Keep pressing the "arrow down" key until you reach the "200# Settings". Press the <ENTER> key.
2. Press the "up" key (for the cyclic display). The menu "260# Password Setting" is opened. Press the <ENTER> key.
3. You are now in the menu "260# Password Setting".

200# Settings

260 Password  
Setting

PW:\*\*\*# Level[0]  
OnTmh 123456 h

- Press the <ENTER> key. You can now enter the password by pressing the arrow up/down keys. The password is the sum of the digits of the operation hours (OnTmh), in the example it is  $1 + 2 + 3 + 4 + 5 + 6 = 21$ .
- Finally press <ENTER> in order to confirm the password entry. You are now in the installer level (1).
- Exit the menu by pressing the <ESC> key.

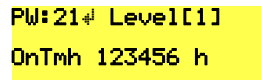
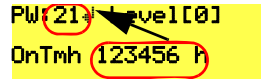

If the password is invalid, the Sunny Island 5048 does **not** switch to the installer level. In this case, recalculate and re-enter the installer password as described in this section.



The installer level is reset to the user level in case that

- the Sunny Island 5048 is switched off and on again (see section 9 „Switching On and Off“ (page 61)),
- certain parameters are entered (e.g. the "250.01 Auto-Str" parameter) that cause a restart,
- a wrong password is entered
- no keys are pressed for a period of five minutes.

## 10.6 Display Messages (Overview)

The display consists of two lines with 16 characters, each. The first line shows the menu number and the menu name or the parameter name. The menu name is additionally described in the bottom line - if applicable (e. g. parameter value).

The following message is shown in the "Home Screen":

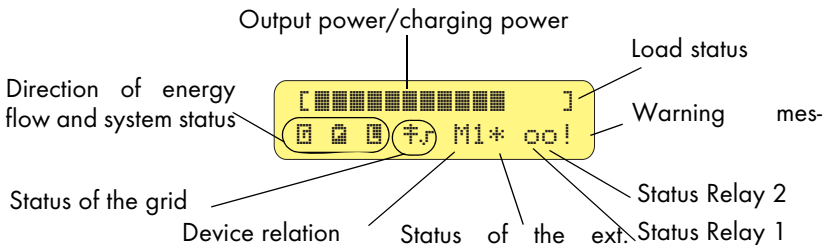

The bar display in the upper line shows the total output or charging power.

On the very right a character shows the load status: "]" indicates nominal power, if the nominal load is exceeded the character changes to ">".

The direction of energy flow and the system status are shown on the left of the bottom line. The symbols stand for the generator side ("Generator/Grid"), the "Battery" and the load side ("Loads/Sunny Boys"). The arrows between the symbols indicate the direction of the energy flow.

The symbol  $\#$  stands for a power pole. The symbol on the right side indicates if the public grid is present ( $\#$ ) or down ( $\times$ ).

The device assignment is shown (master or slave, e.g. M1 or S1)

Next to this the status of the external sources is indicated, where the symbols have the following meaning:

- \* The generator voltage and frequency are within the defined limit:
- "?" Generator voltage and/or frequency are outside of the defined limits. The Sunny Island 5048 will not connect the generator to the stand-alone grid while this situation exists.
- ! The maximum permissible generator reverse power has been exceeded, the Sunny Island 5048 has disconnected the generator from the stand-alone grid.

The following characters indicate why the generator was requested:

- B**(attery) The generator has been requested as a result of the battery state of charge.
- L**(oad) = The generator has been requested as a result of a load dependent request.
- S**(tart) The generator is requested by the operator manually setting the generator request in the Sunny Island 5048 from "Auto" to "Start". The generator is then NO LONGER controlled automatically or switched off by the Sunny Island 5048.
- T**(ime) The generator was started for one hour using the "Run 1h" setting in the Sunny Island 5048. Once this time has passed, the Sunny Island 5048 automatically switches off the generator.



*The generator status and the reason for the request are shown (alternating) under "Generator-Status" in the display.*



*If (e.g.) the display changes every 3 seconds from "\*" to "B", this means that the generator voltage and frequency lie within the specified limits and that the generator was requested as a result of the battery state of charge.*



*If the generator has been manually set to "Stop", no generator status information is shown in the display. The field remains empty.*

The displays for the two relays are shown in the bottom line (filled circle = activated / blank circle = deactivated).

The line ends with a display of warnings (!). This symbol is flashing until the warning has been viewed in the menu "410# Failures Current" or "420# Failure History".

In case of failures the device changes to standby mode and displays the failure. The failure must be fixed and confirmed. After this the Sunny Island 5048 can be restarted.

The Sunny Island 5048 also shows the following values one after the other in the upper line of the "Home Screen" (in 3 second intervals parameter name and parameter value):

- Bar display for output and charging power (the direction of energy flow is displayed by arrows in the bottom line)
- Total power of inverter (cluster)
- Active power of external source (total of all phases)
- Momentary state of charge of battery (SOC)
- Counter (always one of five possible, according to priority)
  - Remaining time of absorption
  - Remaining time of warming up of generator
  - Remaining time of Generator-Run 1 h
  - Remaining time of Timer 1
  - Remaining time of Timer 2
- Active charging process

The display of the bottom line remains as described above.

*The values shown in the display are cyclically displayed depending on the situation. I.E. in case no generator is present, no generator values are shown.*



*The slave devices only show the bar display for output and charging power and the device assignment in the bottom line (e. g. S1 for slave 1) as well as the status of external sources, if applicable (\*, for the description see above).*



## 10.7 Parameter Display

Parameters are shown on the Sunny Island 5048 as follows:

The upper line first indicates the parameter number, then a separator (hash mark), followed by the parameter name. The bottom line shows the value with the respective unit and the modification mark on the very right side (enter arrow).

```
02#Apt.TmBoost
120 min      ↵
```



*The menu numbers are not displayed in case you change to a parameter/value list.*



*The following syntax for menus and parameters apply to the entire document.*

*A menu is marked by a hash mark, menu number and menu names (120# Battery Meters).*

*A parameter is marked by a hash mark, menu number, dot and parameter number (120.02 BatVtg).*

## 10.8 Display of Events

The Sunny Island 5048 can display a list of events:

The upper line shows the consecutive number (quantity) of the event, the display of date and time changes in 2-second intervals. The bottom line shows the event number.

```
001 11:55:01
E108 -----
```

## 10.9 Display of Warnings and Failures

The Sunny Island 5048 can display a list of failures and warnings:

The upper line shows the consecutive number (quantity) of the failure, the display of date and time changes in 2-second intervals. The bottom line shows the failure number and the name of the failure.

```
001 11:55:01 C
F212 Warning
```

"!" on the right of the upper line indicates when the warning and/or failure has occurred.

"C" on the right of the upper line indicates when the warning and/or failure has been acknowledged or cleared.

*By pressing the hot key "ESC and up-key" " the failure list is displayed (420# Failure History).*







## 11 Saving Data on an MMC/SD Card

The Sunny Island 5048 can store firmware, parameters and measured data on a Multimedia-Card (MMC/SD card), that must be FAT-16-formatted and may have a max. size of 2 GB (possible storage sizes are 32/64/128/256/512 MB and 1GB and 2 GB). File names are stored in 8.3 format, files with any other names are ignored.

A valid 8.3 format is for example "M1LOG.DAT".

8.3 is the "previous" MS-DOS format with a file name of max. 8 digits before and 3 digits after the dot.



**SMA Technologie AG recommends to use MMC/SD cards manufactured by Transcend.**

*If you use a storage card by another manufacturer check if it is a FAT-16-formatted card. If required, format the card. Be aware that data stored on the card will be lost.*



After you have inserted the MMC/SD card into the slot of your PC, you can search for the respective drive in the Explorer (under WINDOWS). The following data is saved on this drive (here: E:):

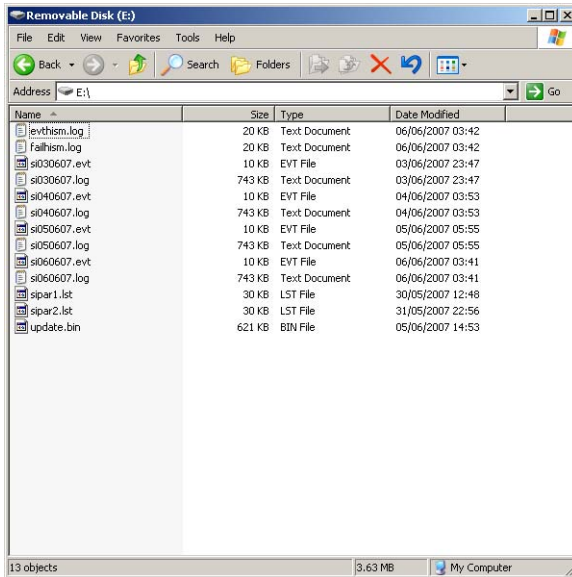

The files saved on the MMC/SD card have the following meaning:

File name	Meaning
evthism.log (evthisN.log for SlaveN)	Event history of the device, saved with parameter "550.01 CardFunc", selection StoEvtHis
failthism.log (failthisN.log for SlaveN)	Failure history of the device, saved with parameter "550.01 CardFunc", selection StoFailHis
si030607.evt	Event/failure history of the day (format ddmmyy)
si030607.log	Data recording of the day (format ddmmyy)
sipar1.lst	Parameter list of the device, generated with parameter "510.02 ParaSto", selection Set1
sipar2.lst	Parameter list of the device, generated with parameter "510.02 ParaSto", selection Set2
update.bin	Software for the device



*The file "BOOTEX.LOG" is not necessarily saved on the card, it is generated according to the operating system used (e. g. WindowsXP or Windows2000).*

The data saved on the MMC/SD card can be processed with usual spreadsheet programs.

The first 14 lines of the file are for information (file header), the next two lines are column headings. The following data is separated by semicolon, decimal places are displayed by a dot, the date format is dd.mm.yyyy, the time format is hh:mm.



*For further information on processing log data see the instructions of the software used.*

The firmware of the Sunny Island 5048 expects device specific data in the root directory of the MMC/SD card. This data consists of a new firmware, parameters and measurement data. Data that does not belong in the root directory is ignored.

*Always use the MMC/SD card for saving data and events. In case of a failure **SMA Technologie AG** can thus quickly help you.*



The Sunny Island 5048 uses the MMC/SD card in order to store and load device parameters.

In addition, the Sunny Island 5048 supports the acquisition of measurement data on the MMC/SD card. It saves this data in a special file. Among other things the file consists of header, time stamp, date and data type. There are three different types of log data:

- Measurement data (cyclically saved)
- Events and failures (only saved when occurring)

The Sunny Island 5048 supports measurement data storage with data of the fields:

- Battery
- Inverter
- System
- External source and
- Loads

## 11.1 Inserting the Card

*In order to avoid problems with electrostatic charging, you must ground yourself before inserting or removing the MMC/SD card at the housing of the Sunny Island 5048.*



Insert the MMC/SD card with the sloping corner at the bottom into the slot of the Sunny Island 5048 (see illustration).

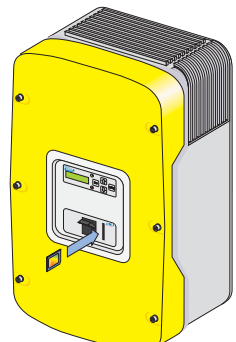

After inserting the MMC/SD card in the Sunny Island 5048, a message is displayed prohibiting the removal of the card:

**Do not remove  
MMC/SD card ...**

Initialization of the MMC-/SD card requires a few minutes. During this time, no entries can be made via the keys and three dots appear the bottom line of the display.

In case the process has been successfully completed the following is shown in the display:

**MMC operatin  
finished**

In case of a failure the following display appears:

MMC operatin  
failed

## 11.2 Removing the Card

In order to ensure that all log data is saved when switching off the device, write all unsaved data from the buffer to the MMC/SD card using the "550.01 CardFunc" parameter and selecting "ForceWrite".



*When removing the MMC/SD card without activating the "550.01 CardFunc" parameter the data is lost for max. 15 minutes.*

## 11.3 Loading and Saving Parameters

The "510.02 ParaSto" parameter lets you save the current settings of the parameters, saved parameters can be retrieved with the "510.08 ParaLod" parameter.



*If the system is working optimally, it is a good idea to save these settings. This is especially useful if you try out new settings and then wish to reset the inverter back to the previous settings.*

When saving the parameters you have the following possibilities:

- Set1 (save parameter set 1)
- Set2 (save parameter set 2)

When loading the parameters you have the following possibilities:

- Set1 (load parameter set 1)
- Set2 (load parameter set 2)
- Factory (load factory settings (reset))



*The write protection function of SD cards (plastic sliding clip on the left side) is not supported by the Sunny Island 5048. You should take note of this when writing data to your card.*

## 11.4 Writing Log Data

It is possible to activate writing of log data to your MMC/SD card (activated by default) via the "550.02 DatLogEna" parameter.

If the Sunny Island 5048 writes data to the MMC/SD card, removing the card is prohibited and the message below is displayed:

Do not remove  
MMC/SD card ...

## 11.5 Status Messages

It is possible to request the status of your MMC/SD card via the parameter "312.07 CardSt#":

Display	Meaning
<b>Off</b>	Your MMC/SD card is deactivated.
<b>Operational</b>	Your MMC/SD card is activated.
<b>Out of Space</b>	The storage space of your MMC/SD card has been exceeded.
<b>Bad File Sys</b>	Your MMC/SD card has an invalid file format.
<b>InCOMP</b>	Your MMC/SD card is incompatible.
<b>Parameter</b>	The Sunny Island 5048 loads parameters from the MMC/SD card.
<b>ParameterFailed</b>	Loading parameters from your MMC/SD card failed.

For help on troubleshooting see section 20.9 "Troubleshooting" (Page 166).



## 11.6 Firmware Update

The firmware of the Sunny Island 5048 can be updated with the MMC/SD card. When the Sunny Island 5048 is started or the MMC/SD card is inserted, the Sunny Island 5048 checks if according update files are stored on the MMC/SD card. In case it detects such update files it conducts an update when the Sunny Island 5048 is in standby.



*Always save the latest firmware version on the MMC/SD card, it is empty (blank) when delivered.*

Set the master device to standby.

Insert the MMC/SD card into the master device.

The messages below are displayed while the master does the update:

Update 1/2

Update 2/2



*After the update has been successfully completed a reset is enforced in order that the changes become effective.*

After the reset the master device remains in standby.

Start the master manually by pressing and holding the <ENTER> key.

In systems with several Sunny Island 5048 the firmware update is only done on the master. In case the master detects that a slave has a different firmware version when starting from standby mode, it transfers its firmware to the slave and therefore ensures that all Sunny Island 5048 within a system run with the same firmware version.



*When a slave with a different firmware version is connected, the master interrupts operation, performs a cluster update and restarts together with the slaves.*

While the master updates the slave(s), the slave(s) display(s) the same message as the master.

Update 1/2

Update 2/2

The following message is displayed on the master:

```
Updating Slaves
```

After the firmware has been updated the parameters are downloaded to the slave devices.

Wait until all slave processes are completed and the following display appears on the Slave devices:

```
Ready
```

```
Wait for Master
```

*Individual parameters and settings are not lost by the firmware update.*







# 12 Additional Functions

## 12.1 Load Shedding

The Sunny Island 5048 can automatically switch off loads to protect the batteries from deep discharge. To do this, an external (AC or DC) power contactor must be installed between the Sunny Island 5048 and the loads (see also section 21.1 "Accessories (Optional)" (Page 173)).

**Installation of the load shedding system is strongly recommended in systems with extensive AC-side coupling of solar power or wind power. This is the only way to achieve safe operation of the system, even in cases of low energy generation or very high consumption.**



**Disconnect only the loads, never disconnect the generators (e. g. Sunny Boys)!**

The time periods  $t1$  and  $t2$  are defined with the parameters "242.05 Lod1Tm1Str" and "242.06 Lod1Tm2Str". The start time for  $t1$  (and the end of  $t2$ ) is defined with "Lod1Tm1Str" and the start time for  $t2$  (and the end of  $t1$ ) is defined with "Lod1Tm2Str". If  $Lod1Tm1Str = Lod1Tm2Str$ , only  $t1$  is active.

The time intervals  $t1$  and  $t2$  are assigned charge states for startup and stop with the "242.01 Lod1SocTm1Str", "242.02 Lod1SocTm1Stp", "242.03 Lod1SocTm2Str" and "242.04 Lod1SocTm2Stp" parameters. "Lod1SocTm1Str" defines the battery state of charge at which the load shedding function is activated during the  $t1$  time and "Lod1SocTm1Stp" defines the state of charge at which the load shedding function is deactivated during  $t1$ . The "Lod1SocTm2Str" and "Lod1SocTm2Stp" are analogously specified during the time  $t2$ .

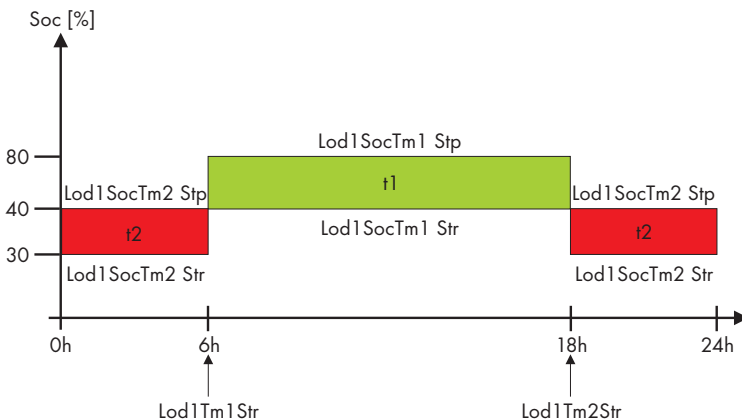

The graphic shows an example for the settings that minimize the load shedding function at night. From 6:00 am to 10:00 pm the load shedding is activated for a charge state (SOC) of 40 %, during nighttime (from 10:00 pm to 6:00 am) the charge state of the battery is allowed to go down to 30 % before the load shedding is activated.

The load shedding function can be assigned two times. In the above mentioned parameters the part "Lod1" resembles the first assigned function, the part "Lod2" resembles a second, identical function. These two battery state dependant load shedding functions allow a step by step load shedding where different load groups with different SOC values can be defined with different priorities.

## 12.2 Sleep Mode

Using the "270.07 SleepEna" parameter set to "Enable" allows the sleep mode to be activated in 1-phase grids, which the master uses to switch off the slaves when the power value allows this.



*The values for connection and disconnection in the Sunny Island 5048 are already set at the factory (optimized in terms of efficiency).*



*The sleep mode cannot be used in grid-coupled operation but only in stand-alone mode.*

## 12.3 Time-controlled Operation

The Sunny Island 5048 can be operated time-controlled using a timer function (like a clock timer) and supplies power at the planned time.

For this, this function must be activated by using the "510.03 InvTmOpEna" parameter. The start date is specified with the "510.04 InvTmOpStrDt" and the start time with the "510.05 InvTmOpStrTm" parameter. The "510.06 InvTmOpRnDur" parameter is used to define the running time and with the "510.07 InvTmOpCyc" it can be set whether the function is performed once, daily or weekly until or from the specified time (date and time).

## 12.4 Overload and Short Circuit Behavior

The Sunny Island 5048 can be temporarily operated under overload conditions. It can also provide short-circuit currents.

In case of overload the Sunny Island 5048 supplies an output of 6500 W for 30 minutes and can supply 7200 W for 5 minutes. The device can even supply 8400 W of output power for one minute.

In the event of a short circuit, the Sunny Island 5048 provides current of max. 100 A (for 100 ms). This is sufficient to trigger commercial 16 A B-type circuit breakers.

## 12.5 Device Failure and Autostart

The Sunny Island 5048 is automatically deactivated in case of a critical failure and indicates this failure in the display. In case the autostart function is activated ("250.01 AutoStr" parameter) the Sunny Island 5048 can automatically confirm the failure and restart on its own. If the failure persists the Sunny Island 5048 cannot be started.

*If the autostart counter has counted down to 0, the Sunny Island 5048 waits for 10 minutes before attempting to automatically restart.*



*Messages can always be displayed during operation, they have priority over the display of the "Home Screen".*



## 12.6 Automatic Frequency Adjustment

Clocks that depend on the stability of the grid frequency for their accuracy, become increasingly inaccurate when subjected to constant frequency deviations. Frequency fluctuations, i.e. deviations from the nominal frequency often occur in (e.g.) stand-alone grids that work with a diesel generator.

The "Automatic Frequency Adjustment (AFRA)" function of the Sunny Island 5048 (also referred to as tertiary control) allows the use of grid-coupled clocks in these types of stand-alone systems. It is activated with the "250.11 TertClE-na" parameter (activated by default).

The difference in time is approximately compensated on average.

*The internal clock in the Sunny Island 5048 is quartz-controlled and is thus correct (within the tolerance limits). The adjustment refers to externally connected clocks which depend on the grid frequency.*





## 13 Battery Management

The battery management of the Sunny Island 5048 supports the following three battery types ("221.01 BatTyp" parameter):

- FLA** **Flooded Lead Acid:** Closed lead acid batteries with liquid electrolyte in all usual versions available on the market (grid-type plates, tubular plates, small, large, etc.)
- VRLA** **Valve Regulated Lead Acid:** Closed lead acid batteries with immobilized electrolyte in gel or AGM (**A**bsorbent **G**las **M**ate Separator) in all standard designs available on the market (grid plates, tubular plates, small, large, AGM, gel, etc.)
- NiCd** **Nickel-Cadmium:** Pocket-type plate or fiber plate closed nickel cadmium batteries

The battery capacity ("221.02 NomBatCpy") parameter is to be entered as the nominal capacity for a ten hour discharge (C10). If this is not available from the battery manufacturer's data sheet, this can be calculated from the data for different discharge times (120h, 100h, 20h, 5h, 1h) in the following manner:

C10	C120/1.28	C10	C10
C10	C100/1.25	C10	C5/0.88
C10	C20/1.09	C10	C1/0.61

The Sunny Island 5048 is designed and preset for a nominal battery voltage ("221.03 BatVtgNom" parameter) of 48 V (24 cells of 2 V, each) in case of lead acid batteries (FLA and VRLA) and 45.6 V (38 cells of 1.2 V, each) in case of nickel/cadmium batteries.

*If individual battery cells fail during the operating lifetime of several years, the nominal voltage can be set in the range from 42 V to 48 V. It is thus possible to remove up to three individual cells and to continue operation of the system.*



### 13.1 Battery Temperature

The Sunny Island 5048 continuously monitors the battery temperature using the battery temperature sensor included in delivery. In case of 5 °C below the maximum permissible temperature ("221.04 BatTmpMax" parameter) a warning message is displayed. If the temperature falls below -10 °C in case of lead acid batteries and -20 °C in case of NiCd batteries a warning is displayed.

The battery temperature is considered when calculating the charging voltage (see section 13.4 "Charge Control" (Page 96)).



*In case the battery temperature sensor is not connected or a short circuit or defective cable in the sensor is detected, a warning message is generated; however, the Sunny Island 5048 continues operation with a preset battery temperature of 40 °C. This can result in insufficient charging of the battery in the long run.*

## 13.2 Start Options

If the battery of a system is exchanged or single cells are removed from the battery bank, the battery management must be restarted and reconfigured via the "Quick Configuration Guide QCG" (see section 8.2 "Starting the Quick Configuration Guide (QCG)" (Page 57)).

## 13.3 Charge State/SOC and SOH

The Sunny Island 5048 has a very precise internal state of charge calculation (display value "120.01 BatSoc"). The procedure for calculating the state of charge is based on balancing the ampere hours. This means that all currents flowing in and out of the battery are accumulated and referred to the nominal capacity. In order to consider failures caused by self-discharge and charging losses due to gassing, these losses are already internally excluded. Unlike in case of other procedures, a fixed charging factor does not have to be set.



**If you intend to connect other loads or generators to the battery, where the currents are not detected by the Sunny Island 5048, an external battery current sensor must be connected to make sure that the state of charge is correctly acquired. In addition, the external battery current sensor improves the accuracy of the state of charge (SOC) and state of health (SOH) acquisition.**

After full charge has been reached, the charge state value is reset to 90 %, 95 % or 100 %, depending on the state of charge of the battery. If default settings are not changed, a state of charge of 90 % after boost charge, 95 % after full charge and 100 % after equalization charge is reached.

Since full charge states are only rarely achieved in specific off-grid applications, the used procedure can use the battery voltage during constant discharge phases with low discharge currents in order to re-calibrate the charge state. In most applications, these phases are achieved at night. Because of this regular recalibration the procedure used has a high level of long-term reliability, compared to the ampere hour balancing method.

Both the ampere hour balancing method and the re-calibration procedure via the voltage automatically adjust to the connected battery by-and-by (approx. 4 to 8 weeks). Since many of the battery types available on the market vary in their behavior, values cannot be specified. The best option is to adjust the respective battery according to the procedures described above.

The estimated failure of the state of charge (display value "120.11 BatSocErr") will continuously provide you with information on the accuracy of the battery state of charge currently calculated. With an increasingly improved adjustment to the actual battery the average failure will be reduced.

Only when the battery is new, the usable capacity corresponds to the capacity specified by the battery manufacturer. As the battery ages and as a result of frequent insufficient charging, the battery's useable capacity may decrease considerably on a permanent or only a temporary basis. The battery's state of health (display value "320.01 Soh") is a percentage measurement for the currently useable capacity relative to the nominal capacity. 100 % means that the entire nominal capacity can be used. 50 % means that only half of the original nominal battery capacity can be used. A self-adapting method, which takes approx. between 4 and 8 weeks to output good and exact values, is also used to calculate the battery's state of health.

The current capacity for the Sunny Island 5048 is automatically adjusted downwards for temperatures  $< 20\text{ }^{\circ}\text{C}$ , since the useable capacity of batteries is drastically reduced at temperatures below the nominal temperature. In case of lead acid batteries, the nominal capacity is adjusted by a fixed factor of  $-1\text{ } \%/^{\circ}\text{C}$ . In case of NiCd batteries a factor of  $-0.75\text{ } \%/^{\circ}\text{C}$  is used.

### 13.4 Charge Control

The Sunny Island 5048 performs charge control in three phases, using the IVOV process. When operated with the public grid, the device has an optional fourth phase, the silent mode.

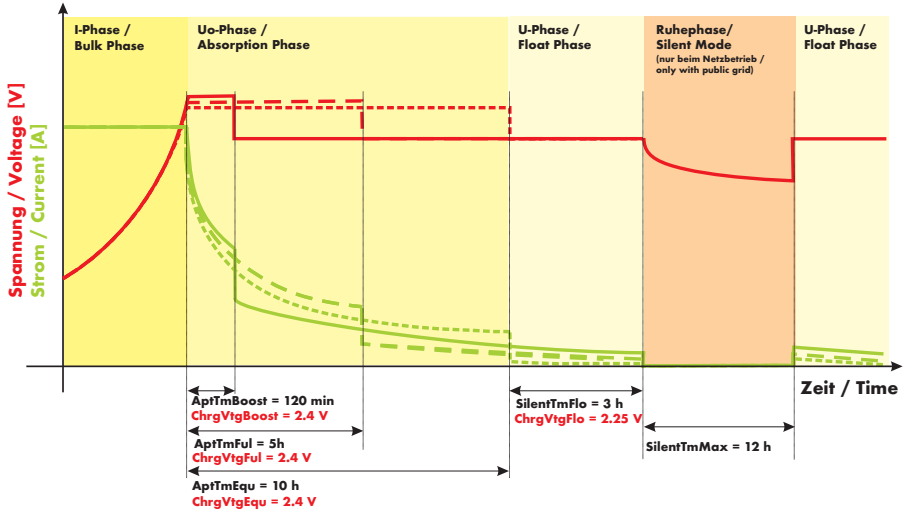

The I stands for the bulk phase (I phase). In this phase, the charging is only limited by the defined maximum battery current ("222.01 BatChrgCurMax" parameter), the nominal generator current ("233.03 GnCurNom" parameter), the nominal grid current ("232.03 GdCurNom" parameter) or the maximum AC charging current of the Sunny Island 5048 ("210.02 InvChrgCurMax"). The respective value reached at first is the limiting value. During this phase the battery voltage increases as the battery is charged.

Once the battery voltage has reached the value defined for the second phase  $V_o$  (parameter "222.07 – 222.09", ChrgVtgBoost or ChrgVtgFul or ChrgVtgEqu), the constant voltage charging (absorption phase) begins. In this phase, the battery voltage is maintained at a constant level, resulting in a continually decreasing battery current. The Sunny Island 5048 remains in this phase for the period of time defined for this phase (parameters "222.01 – 222.03", AptTmBoost or AptTmFul or AptTmEqu). The Sunny Island 5048 automatically selects one of three possible charging methods (boost, full, equalizing) which are described in detail in section 13.4.1 to 13.4.3 for this charging phase. The remaining charging time (display value "120.04 AptTmRmg") of this time and the current processes (display value "120.05 BatChrgOp") are displayed.

The following figure shows the relation and the process diagram of the charging phases and charging process.



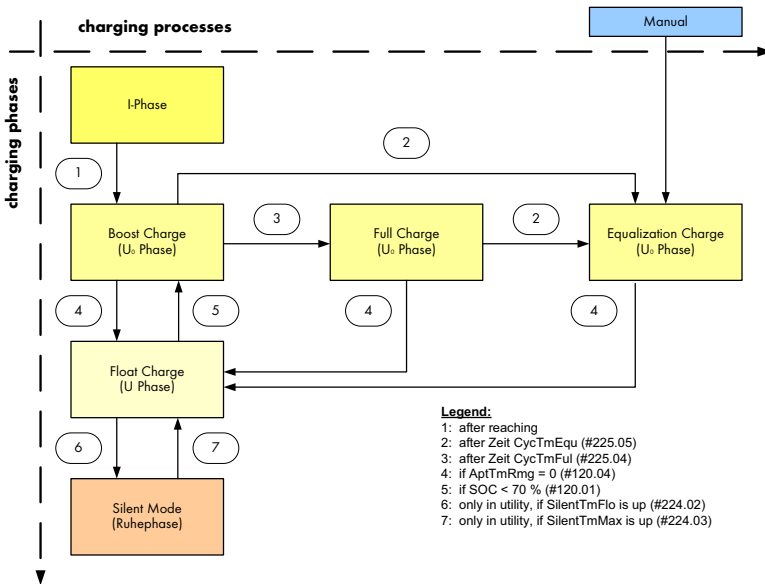

Once this constant current phase is finished, the Sunny Island 5048 enters the float charge which again provides constant current charging but at a largely reduced charging voltage ("222.10 ChrgVtgFlo" parameter). The purpose of the float charge is to keep the batteries in a fully charged state without causing premature aging through overcharging. The Sunny Island 5048 remains in this phase until either more than 30 % of the nominal capacity has been used (all discharges are added up) or the state of charge is below 70 %. From float charge the Sunny Island 5048 can also change to silent mode if connected to the public grid (see section 13.4.5 "Silent Mode" (Page 100)).

The charging voltage is not changed by leaps but slowly by approx. 0.5 mV/cell\*s when changing from the constant current phase to float charge. The same happens when the setpoint is changed manually.



The charging capability of batteries is highly dependent on the battery temperature. For temperatures < 20°C, the charging voltage must be slightly increased, and for temperatures > 20°C it must be slightly decreased. This is necessary to reliably prevent overcharging and insufficient charging at all battery temperatures. For this reason, the Sunny Island 5048 is equipped with automatic temperature compensation of the charging voltage. The charging voltage is adjusted by 4 mV/°C and cell in case of VLA and

FRLA batteries as well as by  $0 \text{ mV}/^{\circ}\text{C}$  and cell in case of NiCd batteries. The value of the temperature compensation can be adjusted with the "222.11 BatTmpCps" parameter.

### 13.4.1 Boost Charge

The boost charge is the most common charging process of the Sunny Island 5048. The boost charge ensures a high generator capacity through a high charging voltage over a short period of time. With liquid FLA lead acid batteries, this charge process should be used for gassing and thus compensating the electrolytes. The boost charge process can charge the battery between approx. 85 % and 90 %.

### 13.4.2 Full Charge

The Sunny Island 5048 initiates a full charge every 14 days ("222.05 CycTmFull" parameter) or every eight nominal charging throughputs, with the aim of reaching a battery state of charge of at least 95 % and removing any negative effects caused by insufficient charging. A regular full charging every two to four weeks can double the battery service life in off-grid systems.



*If the Sunny Island 5048 changes to full charge after a specific time of boost charging has elapsed, the entire time of boost charge elapsed is considered for the full charge.*



*If more than 1 % of the battery's nominal capacity is discharged during a full charge, 50 % of the time elapsed is considered for the next constant voltage phase.*



*In case an external charger or charge controller is connected to the battery and the criteria for a full charge are fulfilled due to external charging, the Sunny Island 5048 treats this as if it had performed the full charge itself.*



*Any parallel procedures causing the generator to stop during the full charging process are not taken into account until the charging process is completed.*

### 13.4.3 Equalization Charge

A battery bank consists of many series-connected individual battery cells which all behave slightly differently. Over time, this results in different charge levels in the individual cells. This can lead to premature failure, initially of individual cells, and finally to failure of the entire bank.

The Sunny Island 5048 can automatically perform an equalization charge every 180 days ("222.06 CycTmEqu" parameter) or every 30 nominal charging throughputs. During this process, it performs controlled overcharging of the battery bank to ensure that even the weaker cells are fully recharged. The Equalization charging extends the battery service life by up to 50 %. The automatic equalization charging function can also be deactivated ("222.12 AutoEquChrgEna" parameter, activated by default) or manually started ("520.01 ManChrgSel" parameter).

*If the Sunny Island 5048 changes to equalization charge after a specific time of boost charging or full charging has elapsed, these times are completely considered for the equalization charge.*



*If more than 1 % of the battery's nominal capacity is discharged during an equalization charge, 50 % of the time elapsed is considered for the next constant voltage phase.*

*In case an external charger or charge controller is connected to the battery and the criteria for an equalization charge are fulfilled due to external charging, the Sunny Island 5048 treats this as if it had performed the equalization charge itself.*

### 13.4.4 Manual Equalization Charge

An equalization charge can be manually triggered for the Sunny Island 5048 at any time using the "520.01 ManChrgSel" parameter. The equalization charge is activated once the manual equalization charge has been manually confirmed. If a generator is connected to the system, it is automatically started and stopped once the equalization charge is completed.

*An equalization charge should be performed at least once a year. After a long period of time without charging, e. g. in case of systems which are only operated seasonally, manual equalization charges are required at the end or at the beginning of the season.*



### 13.4.5 Silent Mode

In addition to the float charge, the silent mode can be used ("224.01 SilentEna" parameter) when operating with the public grid. The main purpose of the silent mode is that in utility backup systems, where the Sunny Island 5048 is predominantly in float charge, energy can be saved by switching from charge mode to standby mode.

The silent mode is activated after the time set for float charge ("224.02 SilentTmFlo" parameter) has expired. The Sunny Island 5048 is in silent mode for a fixed time ("224.03 SilentTmMax" parameter) or until the battery voltage per cell is lower than the voltage set ("222.10 ChrgVtgFlo" parameter) by 0.14 V. This ensures that the battery is always fully charged, even in silent mode. If a grid dropout is detected during silent mode, the Sunny Island 5048 provides a stand-alone grid within a few milliseconds. The loads are supplied with power almost without interruption.

### 13.5 Battery Preservation Mode

The Sunny Island 5048 has a sophisticated battery preservation mode. The battery preservation mode prevents the battery from being deeply discharged as far as possible when the energy supply is low and thus prevents a total system failure as well as damage to the battery.

The battery preservation mode has three levels which are activated via the state of charge (when the charge drops below the respective limit, "223.05 BatPro1Soc", "223.06 BatPro2Soc" and "223.07 BatPro3Soc" parameter):

**Level 1:** The first level is used to switch the inverter into standby mode in times when the energy is not absolutely required (e. g. at night). The start time is defined with the "223.01 BatPro1TmStr" and the stop time with the "223.02 BatPro1TmStp" parameter.

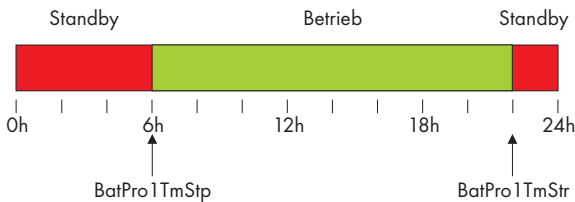

**Level 2:** The second level of the battery preservation mode ensures that the inverter is regularly started every two hours within the time frame when energy is expected to be supplied and attempts to charge the battery from the AC side. In case of PV systems this time is during the day. The start time is defined with the "223.03 BatPro2TmStr" parameter and the stop time with the "223.04 BatPro2TmStp" parameter.

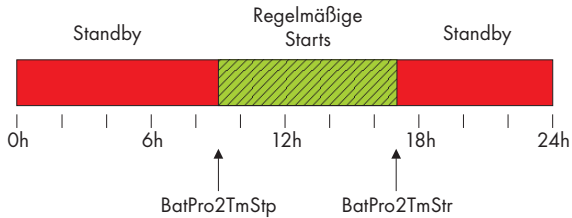

**Level 3:** The third level ensures that the battery is protected from deep discharge and thus protected against damage. The inverter is completely switched off. For starting the inverter, see section 9.5 "Restarting the System after Automatic Shutdown" (Page 64).

In case of all three levels the inverter is only stopped if no battery charging current flows within 5 minutes (limit is charging current of 3 A).

The limits for all three levels can be set independently of each other. It is thus possible to skip individual levels.

If the `BatPro1Soc` parameter < `BatPro2Soc`, level 1 is skipped and only level 2 is conducted.



In case of level 1 and 2 a hysteresis of 5 % of the state of charge is provided for exiting these states.

The battery preservation mode is quit if an external voltage is applied to AC2. However, this function is no longer activated in case the Sunny Island 5048 has completely switched off in level 3.

The battery preservation mode can be quit by manually starting the Sunny Island 5048. In case that a charging current is detected within 5 minutes (s. a.) the Sunny Island 5048 continues to be operated, otherwise, it is disconnected again.

*In inverter mode, the Sunny Island 5048 charges the battery with 25 W. If the device is in stanby mode, only the on-board power supply requiring approx. 4 W is supplied. It is therefore possible to save 21 W.*



*Using the conditions described in level 1 of the battery preservation mode for conversion purposes and assuming an operation time from 6 a. m. to 10 p. m. this results in 336 Wh/day which corresponds to 7 Ah at 48 V, and thus 210 Ah per month (30 days).*

## 13.6 Battery Diagnostics

Many values providing information on the battery's operational behavior in the past are displayed in the menu "320# Battery Diagnosis". These values are useful for checking the efficiency of the set parameters and identifying the typical operating conditions of the battery (see section 19.3 "Diagnostics" (Page 150)).



## 14 Connecting External Sources

The Sunny Island 5048 supports the integration of external energy sources. The integration of a generator and the integration of the public grid is distinguished.

Both the generator as well as the public grid are integrated via the AC2 connection of the Sunny Island 5048. A 1- and a three-phase connection is possible. In case of 1-phase operation the transfer relays are operated in parallel. It is therefore possible to use a respectively larger current which allows a generator or grid connections with a higher capacity.

*When installing parallel 1-phase systems, the connection cables for AC1 and AC2 of all Sunny Island 5048 must have the same cable cross-sections and cable lengths.*



The parameter settings and display values distinguish between generator- and grid-relevant settings and values as well as common settings and values (EXT) for grid and generator. The Sunny Island 5048 has separate parameters for grid and generator. It is therefore possible to use both operating modes without additional adjustments.

### 14.1 Generator

Depending on the battery state of charge or the consumer power, the Sunny Island 5048 can start and stop a generator. Different limits and times are considered (see limits and power flow controller)

#### 14.1.1 Connecting Generator Connections in Parallel

In case of Sunny Island 5048 connected in parallel which are operated on the same phase and within the same cluster, the internal transfer relay is activated simultaneously. It is thus possible to multiply the generator current and therefore to connect a larger generator or a higher grid current.

The maximum value of the current depends on the number of transfer relays and thus the number of Sunny Islands connected in parallel. A current of max. 56 A can be assumed for each Sunny Island 5048, which would mean, in case of four Sunny Island 5048 connected in parallel, a maximum generator current of four times 56 A, i. e. 224 A.

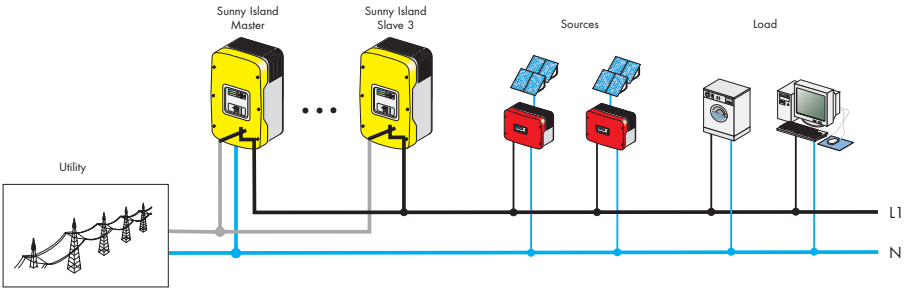

### 14.1.2 Generator Start Options

The Sunny Island 5048 supports the following options for the generator start which can be set in standby mode with the "233.07 GnStrMod" parameter:

- Manual
- Autostart
- GenMan

#### Manual (Manual Generator Start)

This setting is for generators that do not have an electrical remote starting option and are started using cable winches, cranks, among others.

The Sunny Island 5048 has no possibility to start the generator. It solely monitors the generator input (AC2). In case the SI5048 detects that the voltage and frequency of the generator is within the defined limits (see 14.1.6 "Limits and Power Adjustment" (Page 114)), it is synchronized and connected after a certain warm-up time.

The following illustration shows the principal operation of a generator that cannot be started remotely:

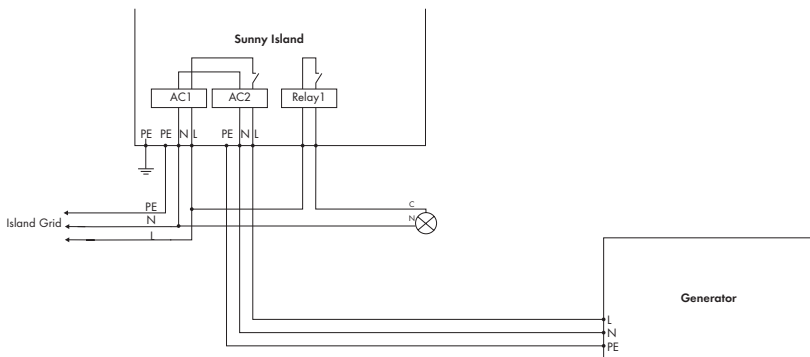



The generator is always deactivated manually. The Sunny Island 5048 automatically switches to operation without generator.

*The GnReq signal (see 15 "Relay" (Page 125)) is used for signaling the generator request and can also be used as signaling contact. In case the generator is no longer required the signal is deactivated.*



*In case this request occurs when the generator is running the signal is suppressed until the generator has externally been stopped and the stop time has expired (30 seconds).*

*A disconnecter should be positioned between the Sunny Island 5048 and the generator. In case the generator shall be stopped, the generator is manually disconnected via the disconnecter and then stopped. Actuation of the generator when switching off is thus prevented.*



## Autostart

This option allows to integrate so-called autostart generators. These have an internal controller that controls the start procedure.

The Sunny Island 5048 requests the generator via the GnReq signal. In case voltage and frequency are within the defined limits (see 14.1.6 "Limits and Power Adjustment" (Page 114)), it is synchronized and connected after the warm-up time.

The Sunny Island 5048 keeps the request signal active until a disconnection has occurred and a preset post run period was completed.

*Autostart generators can have an internal after-run which is activated after the request has been disabled. The after-run period can thus be accordingly longer.*



*With some generators the voltage is only switched to the output when the internal warm-up phase is completed. The time of the generator activation sequence is thus internally monitored.*



*Time for connection = 10 minutes in case of GenMan and/or  $2 \times "233.10 \text{ Gn-CoolTm}" + 2 \text{ minutes}$  for manual and autostart.*

The following figure shows the generator types that can be automatically started in principle:

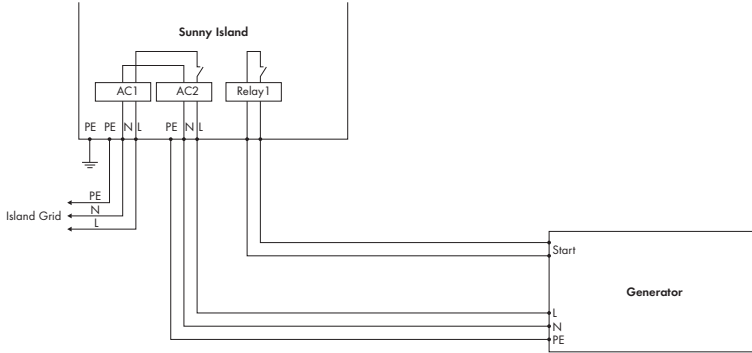

In case the generator is manually started in this operating mode, the Sunny Island 5048 detects the running generator and connects it after warming up. If the generator is externally stopped, this is detected, the generator is disconnected and the stand-alone grid is continued to be supplied.



*In case a generator request is required during the period of time where the generator was started externally, the GnReq signal is disabled until the generator is externally stopped again and the stop time has expired.*

## GenMan

If a GenMan (generator manager) (SMA order number: "SI-GenMan-...") is integrated in the the system, it is responsible for direct generator control. It is connected between the Sunny Island 5048 and the generator. The GenMan is responsible for controlling the generator (warm-up time, cooling off time and autostart).

The Sunny Island 5048 requests the generator from the GenMan via the GnReq signal and keeps the signal active as long as the generator is required. The GenMan indicates if the generator is ready with the GENRDY signal via DigIn. After this, the Sunny Island 5048 can synchronize and connect. In case the generator is not required anymore, the Sunny Island 5048 disconnects and deactivates the GnReq signal.

The following figure shows the generator start with the generator control "GenMan" in principle:

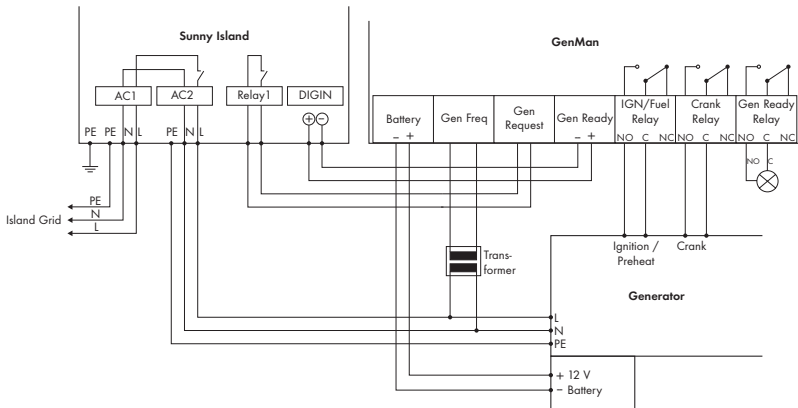

The Sunny Island 5048 is notified of the manual start by the GENRDY signal at the GenMan. It synchronizes and connects it.

In case the generator is manually started externally at the GenMan-Box, the Sunny Island 5048 blocks the GnReq signal:

- Manual stop and start at the Sunny Island 5048 (operation via display and keyboard) are ignored.
- Internal requests (e.g. via battery state of charge) are ignored as well.

*In case the generator was manually started at the GenMan it must also be stopped there.*



The Sunny Island 5048 disconnects the generator after the GENRDY signal has been withdrawn by the GenMan.

*A manual start directly at the generator is not permitted (see GenMan manual).*



### 14.1.3 Generator Operation

The Sunny Island 5048 allows automatic operation (depending on state of charge or load) (see section 14.1.5 "Automatic Generator Operation" (Page 110)). In addition, manual operation is also possible.

### 14.1.4 Manual Generator Operation

The manual operating modes are activated for the generator management via the "540.01 GnManStr" parameter. The following operating modes are distinguished:

- Auto:** In case of this operating mode, the generator is automatically started due to the settings. This includes the start via the state of charge or the consumer power or by request for a manual equalization charge ("520.01 ManChrgSel" = Start).
- Stop:** Manual stop of the generator if manually started. The current generator request is canceled - immediate disconnection from generator and change to lock state. Once the lock time has finished the generator switches to automatic operation.
- Start:** Manual Generator Start: Generator is running "endlessly" until Stop
- Run1h:** Operation for one hour. After lock time has expired change back to Auto.



**In case the generator has been manually started (start), it is required to be manually stopped (stop).**

Equalization charge can be manually started using the "520.01 ManChrgSel" parameter. The battery management (see section 13 "Battery Management" (Page 93)) is thus set into the equalization charge state and requests the generator. This request persists until equalization charge has been completed.

The following sequence charts provide an overview of the start/stop behavior of the Sunny Island 5048 in case of automatic generator operation:

### Generator Interface 233.07 GnSrtMod Manual; Start at the Generator

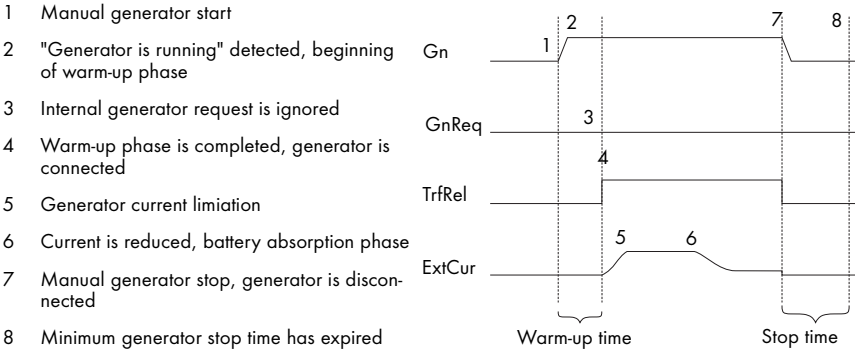

### Generator Interface 233.07 GnSrtMod Autostart; Start at the Generator

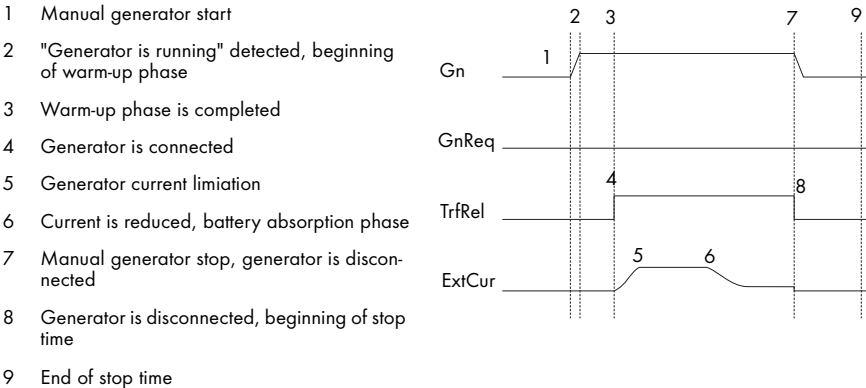

## Generator Interface 233.07 GnSrtMod GenMan; Start at the Genera-tor

- 1 Generator start at GenMan
- 2 Beginning of GenMan generator warm-up phase
- 3 Generator warm-up time
- 4 GenMan sends ready for connection signal
- 5 Sunny Island 5048 connects generator
- 6 Current limitation
- 7 Current is reduced, battery absorption phase
- 8 Gen-Man sends generator stop signal (man Auto!)
- 9 Sunny Island 5048 disconnects generator
- 10 Post-run period completed, generator stop
- 11 Stop time has expired

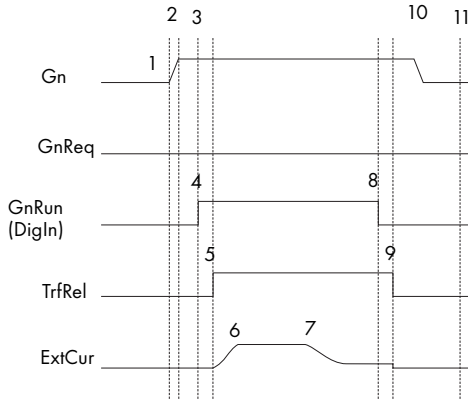

### 14.1.5 Automatic Generator Operation

In automatic operating mode ("241.01 GnAutoEna" parameter), the Sunny Island 5048 defines via the settings (depending on battery state of charge and/or load), when the generator will start and how long it will be running. The automatic operating mode is enabled via GnAutoEna = On. If GnAutoEna = Off the automatic operating mode is deactivated.

In addition, the user can manually start and stop the generator.

#### State-of-charge dependent start



**Manual settings on the Sunny Island 5048 have a higher priority than automatic operating mode. If the Sunny Island 5048 is manually stopped while the automatic operating mode is activated the Sunny Island 5048 changes to operating mode stop/lock.**

**If the generator autostart is activated and the conditions for automatic operation are met, the Sunny Island 5048 changes back into the start operating mode after lock time (or manual acknowledgment via "540.02 GnAck" parameter).**

The time periods t1 and t2 are defined with the parameters "234.07 GnTm1Str" and "234.08 GnTm2Str". The start time for t1 (and the end of r2) is defined with "GnTm1Str" and the start time for t2 (end of t1) is defined with "GnTm2Str".

If  $GnTm1Str = GnTm2Str$ , only  $t1$  is active!



The time intervals  $t1$  and  $t2$  are assigned charge states for start-up and stop with the "234.03  $GnSocTm1Str$ ", "234.04  $GnSocTm1Stp$ ", "234.05  $GnSocTm2Str$ " and "234.06  $GnSocTm2Stp$ " parameters.  $GnSocTm1Str$  defines the battery state of charge at which the generator is started during the  $t1$  time and  $GnSocTm1Stp$  defines the state of charge at which the generator is switched off during  $t1$ . The  $GnSocTm2Str$  and  $GnSocTm2Stp$  are analogously specified during the time  $t2$ .

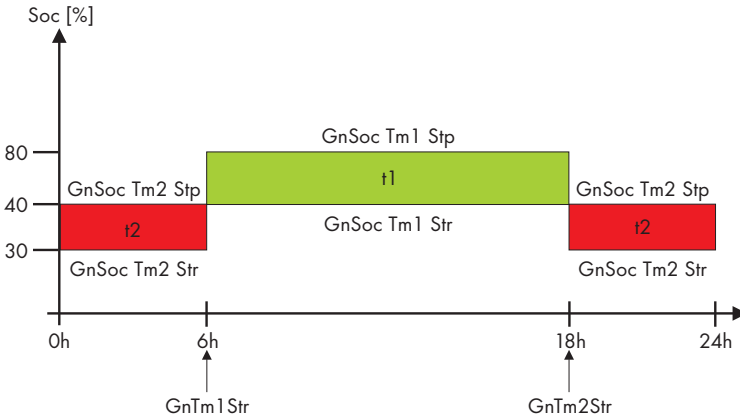

The graphic shows an example of the settings in case the generator is not to operate at night. The generator is started at a state of charge of 40 % from 6 a. m. to 10 p. m. However, the battery may be discharged to 30 % at night (from 10 p. m. to 6 a. m.) before the diesel generator is started.



If the float charging process (see section 13.4 "Charge Control" (Page 96)) is activated before the disconnection limit ( $GnSocTm1Stp$  and/or  $GnSocTm2Stp$ ) has been achieved, the generator request is revoked. In case full or equalization charge is active, the generator is only stopped after this charge will be completed instead of after "234.04  $GnSocTm1Stp$ " or „234.06  $GnSocTm2Stp$ " have been completed.



## Load-dependent Start

The generator can be requested for supporting reasons in case of increased power consumption. This function can be activated or deactivated (default) via the "234.09 GnPwrEna" parameter. The function is only active if the "234.01 GnAutoEna" is set to On.

The load limit for the request and stop of the generator is configured via the "234.10 GnPwrStr" and "234.11 GnPwrStp" parameters. The averaging time for the calculation of consumer power average value can be set with the "234.12 GnP-wrAvgTm" parameter. It can thus be prevented that temporary consumption peaks of some seconds result in a power-dependent generator start.

In case the generator has been started load-dependently the generator runs for the generator minimum runtime. If the averaged power is below the disconnection limit the generator is stopped again.



*Only the total consumer power of all phases are considered. Single phases within a multi-phase system are not monitored.*

*The consumer power is determined by the inverter power ("111.01 TotInvPwrAt") and generator power ("131.01 TotExtPwrAt").*

The following sequence charts provide an overview of the start/stop behavior of the Sunny Island 5048 in case of automatic generator operation:

### Generator Interface 233.07 GnSrtMod Manual; Request by Sunny Island 5048

- 1 Generator requested by Sunny Island 5048
- 2 Manual generator start
- 3 "Generator operation" detected, beginning of warm-up phase
- 4 Warm-up phase is completed, generator is connected
- 5 Generator current limitation
- 6 Minimum run time has expired
- 7 Current is reduced, battery absorption phase
- 8 Charging process is completed, request signal is disabled
- 9 Manual stop of generator
- 10 Generator is disconnected
- 11 Stop time has expired

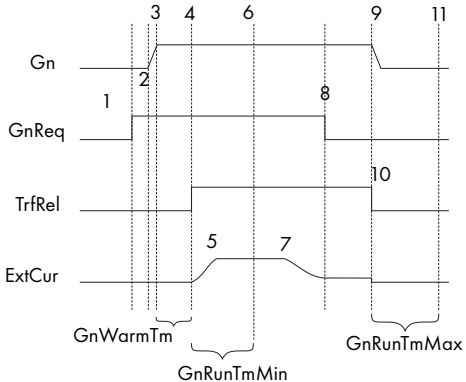



## Generator Interface 233.07 GnSrtMod Autostart; Request by Sunny Island 5048

- 1 Generator started by Sunny Island 5048
- 2 Generator Start
- 3 Beginning of warm-up time
- 4 Warm-up time has expired
- 5 Generator is connected
- 6 Current limitation
- 7 Minimum operating time has expired
- 8 Current is reduced, battery absorption phase
- 9 Charging process is completed, generator is disconnected
- 10 Post-run period is completed, generator is disconnected
- 11 Stop time has expired

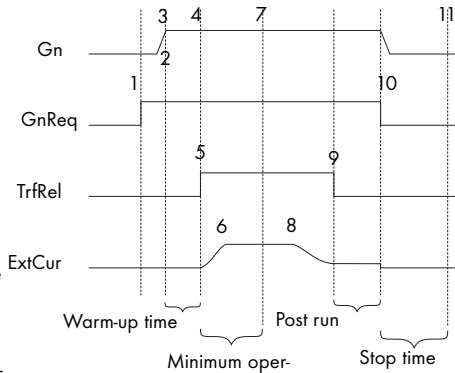

## Generator Interface 233.07 GnSrtMod GenMan; Request by Sunny Island 5048

- 1 Generator started by Sunny Island 5048 at GenMan
- 2 Generator start by GenMan
- 3 Beginning of GenMan warm-up time
- 4 GenMan warm-up time has expired, connection signaled by GenMan at the Sunny Island 5048
- 5 Sunny Island 5048 connects generator
- 6 Current limitation
- 7 Minimum run time (Sunny Island 5048) has expired
- 8 Current is reduced, battery absorption phase
- 9 Charging process is completed, generator is disconnected by Sunny Island 5048
- 10 Signal at GenMan
- 11 GenMan after-run time has expired, generator stopped
- 12 Stop time has expired

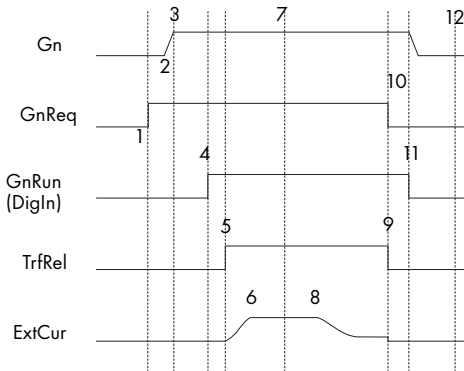



*Even in case of power-dependent generator start, warm-up, minimum and after-run periods are complied with.*

### 14.1.6 Limits and Power Adjustment

The voltage limits can be set using the "233.01 GnVtgMin" and "233.02 GnVtgMax" parameters and the frequency limits for generator operation can be set using the "233.05 GnFrqMin" and "233.06 GnFrqMax" parameters. If the values are beyond these limits the generator is disconnected. Slightly restricted limits apply to generator connection.



*The system voltage (AC) depends on the generator voltage when the generator is running.*

Voltage and frequency limits are monitored in phases. At least the phase on the master device must comply with the limits defined for connecting the generator. Slave devices individually connect or disconnect, where applicable, in case the limits are not complied with.



*If the master device disconnects the generator, all slave devices are disconnected as well.*



*If a slave device is disconnected from a generator (and the master continues to be connected to the generator), the slave device can reconnect once the voltage and frequency are within the valid range again. In this case, a time for monitoring is running. The slave is only reconnected after the detected voltage and frequency for the "233.12 GnWarmTm" are within the valid range.*

The Sunny Island 5048 charges the generator during each phase using the current specified in the "233.03 GnCurNom" parameter. The power that is not directly used by the loads flows into the battery for charging. The limits for the AC charging current limit ("210.02 InvChrgCurMax" parameter) on the Sunny Island 5048 and the DC charging current limit ("222.01 BatChrgCurMax" parameter) are active at the same time. Low values for this limit can be the reason why the generator current defined cannot be regulated. If the battery voltage reaches the charging voltage nominal value, it is also reduced (see section 13.4 "Charge Control" (Page 96)).

*A sensible value for the "233.03 GnCurNom" parameter is approximately 80% of the maximum generator current for each phase.*



If the "233.15 GnCtlMod" parameter is set to CurFrq, the generator is also limited at frequencies lower than the nominal frequency ("233.04 GnFrqNom" parameter). This function can be used if the full generator output is not always available and you want to prevent the generator from being overloaded. The default setting is only intended to control the nominal generator current.

If the current set using the "233.03 GnCurNom" parameter is not sufficient for powering the loads, the battery provides support ("real generator support").

The Sunny Island 5048 provides all the required reactive power.

## 14.1.7 Run Times

If the generator is started (or the Sunny Island 5048 detects an external generator start), the warm up phase starts. If, during this time, the voltage or frequency detected is not within the permissible range, the warm up time begins again. If the generator cannot be connected at the GenMan within twice the time of "233.12 GnWarmTm" + 2 or 10 minutes, the connection process is cancelled and a new attempt is made. After three attempts, the system changes to error state (Fail). Once the 5-minute error wait time has expired, a new attempt is made.

If the generator has been connected, the minimum run time begins ("233.08 GnOpTm-Min" parameter). The generator remains connected during this time, even if in the meantime the generator request is no longer pending.

If the minimum run time has expired and a request is no longer pending or the system detects that the set limits have not been maintained, the generator disconnects and enters the power down phase (Cool). If this power down phase is completed after the "233.10 GnCoolTm" time, the generator is stopped.

*The power down time ("233.10 GnCoolTm" parameter) defined on the Sunny Island 5048 should be set equal to or preferably above the power down time of the GenMan.*



If a generator fault (e.g. generator failure) is detected, the generator is also disconnected and then stopped immediately. In doing so, the power down time is skipped.

Once the stop time ("233.09 GnStpTmMin" parameter) has expired, the generator is ready for the next request.



*An internal generator request is disabled during the power down time and stop time or in error state.*

If a generator fault is detected several times and the number of autostarts ("234.02 GnAutoStr" parameter) has been exceeded, the system changes to the locked error state. This state remains active for the "233.11 GnErrStpTm" time. Once this time has expired, the generator is ready for another attempt.



*The recording of autostarts is only reset after the generator has been successfully connected and the minimum run time has expired or when the locked error state (FailLock) is disabled.*



*The error state as well as the locked error state can be cancelled by confirming the generator fault ("540.02 GnAck" parameter).*

The "140.03 GnRmgTm" process value is used to display the remaining time of the generator meter. Depending on the current request or the phase in which the generator state machine is, the following times are displayed:

- Remaining time of Run 1 h
- Remaining run time during the warm up time (Warm)
- Remaining minimum run time in operation (Run)
- Remaining run time during the power down time (Cool)
- Remaining stop time after the power down time has expired (Lock)
- Remaining time in the error state (Fail)
- Remaining time in the locked error state (FailLock)

### 14.1.8 Operation Together With Sunny Boys

If the battery is fully charged, the frequency limits the power output of the AC feed-in generators (Sunny Boys). If the generator is now manually started, for example, the frequency would be lowered, if required, as the Sunny Island 5048 synchronizes with the generator. The AC feed-in generators (Sunny Boys) would then feed additional energy into the system and possibly overload the batteries. In order to prevent this during such conditions, the stand-alone grid frequency is temporarily increased ("231.04 AcSrc-FrqDel" parameter), in line with the synchronization, until the AC feed-in generators (Sunny Boys) are disconnected from the stand-alone grid as a result of the grid limits being exceeded.

### 14.1.9 Stopping the Generator

If the Sunny Island 5048 (automatically or manually) has started the generator, it can be manually stopped at any time using the "540.01 GnManStr" parameter. This disconnects the generator (the minimum run time is not taken into account here) and the power down time (Cool) is skipped. Afterwards, the system enters the the stop time (Lock).

**If the generator start is performed directly at the GenMan or the generator, it can only be stopped there again. Triggering a stop here only disconnects the generator and the system enters the stop time (Lock).**



*Generators with the manual start option can generally only be started and stopped at the generator.*



*If the generator start is to be disabled after a manual stop, this must be performed by setting the "234.01 GnAutoEna" parameter to Off.*



### 14.1.10 Stopping the Sunny Island 5048

If the Sunny Island 5048 is stopped by the user, the generator is immediately disconnected. The generator is then stopped (generator request, GnReq, is disabled). The power down phase (Cool) is skipped and the system enters the stop time.

**If the generator is started directly at the generator management box or the generator, it can only be stopped there again. Stopping the Sunny Island 5048 here only disconnects the generator and the system enters the stop time (Lock).**



## 14.1.11 Failures

### Reverse Power

If the reverse power ("233.13 GnRvPwr" parameter) set for the "233.14 GnRvTm" time is exceeded, the generator is disconnected and stopped. The power down time (Cool) is skipped and the system enters the minimum stop time (Lock). After reverse power, connection is blocked for at least "231.03 ExtLkTm" or "233.09 GnStpTmMin".

### Generator Failure

If a generator failure is detected (failure on the master phase), the generator is disconnected immediately and a stop signal occurs on the generator. Afterwards, the system enters the minimum stop time (Lock).

### Generator Phase Failure

The failure of a phase (e.g. broken fuse) on a slave device is treated as a phase failure. The slave device then disconnects this phase. If the phase is detected as being available again, it is reconnected after the warm up time "233.12 GnWarmTm" has expired.

The phase failure on the master device is treated as a generator failure (see above).

### Slave Device Failure

If a slave device fails, the system continues to operate using both the remaining devices of the cluster as well as those on the generator.

## 14.2 Grid

The Sunny Island 5048 supports the operation of grid backup systems on the grid. Here, a distinction is made between two main states: either a main power grid and stand-alone grid are connected or a main power grid and stand-alone grid are disconnected. The operating mode of the inverter is derived from this. If the stand-alone grid is disconnected, the inverter is solely responsible for powering this stand-alone grid. If the grid is connected to the stand-alone grid, the stand-alone grid is powered from the main power grid. The voltage and frequency in the stand-alone grid and in the main power grid are identical.



*Under specific conditions, the system can also temporarily feed energy from the stand-alone grid into the main power grid in the GridCharge operating mode ("232.08 GdMod" parameter).*

### 14.2.1 Conditions

In order to operate on the grid, very strict limits (for voltage and frequency) must generally be maintained. This strict limits are not sensible for generator operation. The limits are therefore set separately for grid operation and the generator limits are not used.

The default settings for limits during grid operation comply with the following standards:

- For 230V\_50Hz: DIN VDE 0126-1-1 (not entirely)
- For 220V\_60Hz: UL1741



**The Sunny Island 5048 does not meet the VDE 0126-1-1 directive required in Germany and, for legal reasons, it must therefore be MSD-certified (e.g. by UfE GmbH) when operated while connected to the public grid.**



## 14.2.2 Starting up Sunny Island 5048

The Sunny Island 5048 always starts in stand-alone grid operation. Once the device is operating, it checks for the presence and availability (voltage and frequency) of the external grid.

## 14.2.3 Stand-Alone Grid Operation

The main power grid and stand-alone grid are disconnected and the inverter powers the stand-alone grid. The system waiting for the grid to reconnect is an indication of this state.

As long as the battery has a sufficient charge level, the loads are powered. In stand-alone operation, the AC feed-in generators (e.g. Sunny Boys) perform a charge operation, if required.

## 14.2.4 Grid Reconnection

In stand-alone operation, the inverter constantly checks whether the grid has been reconnected (see above). If the voltage and frequency of the main power grid are within the permissible range of the "232.07 GdVtgMin" and "232.01 GdVtgMax" parameters for the "232.02 GdVldTm" time and the frequency is within the permissible range of the "232.05 GdFrqMin" and "232.06 GdFrqMax" parameters (see also section 14.2.1 "Conditions" (Page 118)), the stand-alone grid is synchronized with the main power grid and then connected.

## 14.2.5 Grid Operation

In grid operation, the stand-alone grid and main power grid are connected. The inverter is simultaneously connected along with the stand-alone grid to the main power grid. In this case, the voltage and frequency in both grids are identical.

*All grid failures that occur during grid operation affect the stand-alone grid.*



In grid operation, the grid monitors whether the permissible limits for voltage and frequency (see Grid Reconnection) are maintained or whether the grid fails to assume powering the stand-alone grid. To do this, the main power grid is disconnected (grid backup operation).

The battery is generally charged or its charge is maintained on the grid.

### Charge Mode

Charge mode on the grid is indicated by energy flowing to the battery. The battery is charged until the respective charge process (Boost, Full, Equalize) has been completed and the system changes to float charge (Float).

### Silent Mode

In order to save energy, the silent mode can be activated using the "224.01 SilentEna" parameter along with the enable setting (default disable). In this case, the Sunny Island 5048 is set to standby mode if the charge has been completed and the battery was in float charge for some time (see section 13.4.5 "Silent Mode" (Page 100)).

The silent mode is quit regularly to recharge the battery.

### Grid Feeding

Whether energy is fed from the stand-alone grid into the main power grid is controlled using the "232.08 GdMod" parameter. If GridCharge (Default) is set, no energy is fed into the grid. If GridFeed is set, energy is fed into the grid.



*In order to allow electricity to be fed from the battery into the grid, the battery voltage in a charged battery (on the grid) must be increased by external DC chargers above the nominal charging voltage.*

AC feed-in generators on the stand-alone grid side (Sunny Boys) can feed their energy into the grid through the internal transfer relay of the Sunny Island 5048; for limitations, see section 14.2.8 "Limits and Power Adjustment" (Page 121).

## 14.2.6 Grid Failure

A grid fault is characterized by the voltage or frequency being outside of the permissible limits (see section 14.2.4 "Grid Reconnection" (Page 119)) or the main power grid being disconnected. In this case, the time limits are relevant: Smaller deviations are permitted for longer than large deviations (see section 14.2.1 "Conditions" (Page 118)).

In case of a grid fault/failure, the main power grid is disconnected and the inverter starts, if it is not already running (silent mode).

*A grid failure occurring while the Sunny Island 5048 is in silent mode can cause a temporary grid failure in the stand-alone grid.*



## 14.2.7 Failures



## Reverse Power

If the reverse power ("232.09 GdRvPwr" parameter) set for the "232.10 GdRvTm" time is exceeded, the grid is disconnected. After reverse power, connection is blocked for at least "232.07 GdVldTm".

## Grid Failure

If a grid failure is detected (failure on the master phase), the grid is disconnected immediately.

## Grid Phase Failure

The failure of a phase (e.g. broken fuse) on a slave device is treated as a phase failure. The slave device then disconnects this phase. If the phase is detected as being available again, it is reconnected.

The phase failure on the master device is treated as a grid failure (see above).

## Slave Device Failure

If a slave device fails, the system continues to operate using the remaining devices of the cluster.

## 14.2.8 Limits and Power Adjustment

The Sunny Island 5048 charges the generator during each phase using the current specified in the "233.03 GnCurNom" parameter. The power that is not directly used by the loads flows into the battery for charging. The limits for the AC charging current limit ("210.02 InvChrgCurMax" parameter) on the Sunny Island 5048 and the DC charging current limit ("222.01 BatChrgCurMax" parameter) are active at the same time. If the battery voltage reaches the charging voltage nominal value, it is also reduced (see section 13.4 "Charge Control" (Page 96)).

If the current set using the "232.03 GdCurNom" parameter is not sufficient for powering the loads, the battery provides support.

*When silent mode is activated, the generator cannot be supported!*



## 14.2.9 Operation Together With Sunny Boys

Since electricity is fed into the grid through the relay of the Sunny Island 5048, they must be prevented from overloading. For this reason, reverse power monitoring is used that, if required, establishes the connection to the main power grid if the reverse power limit is exceeded or an excessive load is applied to the relay.



**If the current flowing through the relay exceeds the maximum permissible current, the grid is disconnected (relay protection). The quantity of PV output installed in the stand-alone grid must not exceed the maximum quantity allowed by the AC input (see section 22 "Technical Data" (Page 175)).**

If the battery is fully charged, the frequency limits the power output of the AC feed-in generators (Sunny Boys) in the stand-alone grid. If the grid is now reconnected, the frequency would be lowered, if required, as the Sunny Island 5048 is synchronized with the grid. The AC feed-in generators (Sunny Boys) would then feed additional energy into the system and possibly overload the batteries. In order to prevent this during such conditions, the stand-alone grid frequency is temporarily increased ("231.04 AcSrc-FrqDel" parameter), in line with the synchronization, until the AC feed-in generators (Sunny Boys) are disconnected from the stand-alone grid as a result of the grid limits being exceeded.

## 14.3 Generator and Grid

In addition to the public grid, a generator can also be integrated into a backup system as a secondary protective measure. This is particularly useful in case of long-term grid failures, even if the battery size is no longer sufficient to bridge the failure after a period of time.

The standard solution in such cases is to use a transfer switch that can be purchased as a manual or an automatic switch. By using such a switch, a diesel generator is connected to the AC2 connection, to which the public grid is normally connected, as displayed in the figure below:

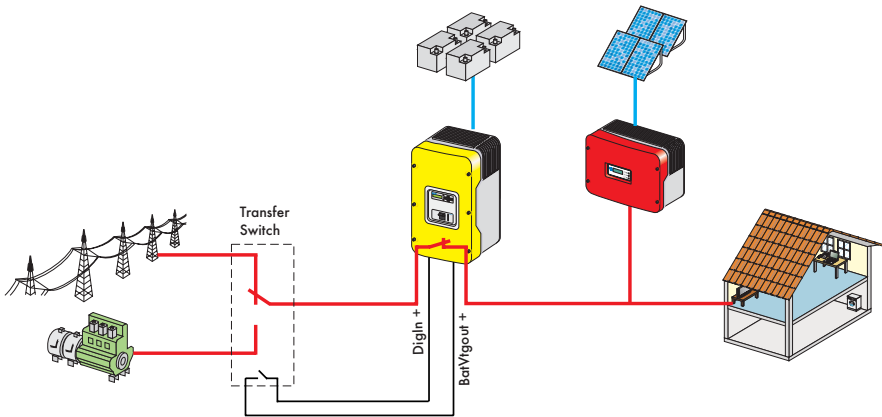

To use such a switch, proceed with the installation as follows:

1. Connect the negative pole of the DigIn connection on the Sunny Island 5048 to the negative pole of the BatVtgOut that is also located on the Sunny Island 5048.
2. Connect the positive pole of the DigIn connection to a NO connection of an auxiliary contact of the transfer switch.
3. Connect the positive pole of the BatVtgOut connection to the second contact of the same auxiliary contact on the transfer switch.

An auxiliary contact is used because the Sunny Island 5048 must “know” whether it is connected to the public grid or whether it must manage a diesel generator.

To enable such operation, the “GB+G” (GridBackup + Generator) selection is mandatory (see section 8.2 “Starting the Quick Configuration Guide (QCG)” (Page 57)).

*All the settings made for the generator and grid in the submenu also apply to the “GridBackup + Generator” selection.*





# 15 Relay

The Sunny Island 5048 lets you control internal and external processes. The device is equipped with two relays, that you can configure with the "241.01 Rly1Op" and "241.02 Rly2Op" parameters. Information on connecting the relays is provided in section 6.4.4 "Multi-function Relays 1 and 2" (Page 47). The different settings are explained in the following:

Function/ Settings	Meaning	Function Description
Off		Relay is permanently off (deactivated)
On		Relay is permanently on (e. g. test of relay function when commissioning)
AutoGn	Automatic generator request	Generator is automatically connected because of criteria set (see section 14.1.5 "Automatic Generator Operation" (Page 110)).
AutoLodExt	Automatic load shedding depending on an external source	Automatic connection/disconnection of loads Load is only connected in case the device is connected with external source (e. g. generator) or absorption phase is active
AutoLodSoc1	Auto LoadShedding Soc1	Automatic connection/disconnection of loads Load is only connected in case SOC limit 1 has passed a defined value
AutoLodSoc2	Auto LoadShedding Soc2	Automatic disconnection of loads Load is only connected in case SOC limit 2 has passed a defined value
Tm 1	Timer 1 (time-controlled switching of the relay1)	Programmable timer (clock timer) (one-time, daily, weekly) with starting time
Tm 2	Timer 2 (time-controlled switching of the relay2)	Programmable timer (clock timer) (one-time, daily, weekly) with starting time
Apt+Phs	Absorption phase active	Relay switching when battery charge is in absorption phase
GnRn	Generator active	Relay switching when generator is in operation and connected.
ExtVfOk	External voltage and frequency is OK	External voltage and frequency are in valid range for connection
GdOn	Public grid	Relay switching when public grid is present and connected.
Error	Failure	Sunny Island 5048 has failure, contact open in case of failure (relay deactivated)
Rn	Run	Sunny Island 5048 in operation, contact is closed (relay activated), when device is in inverter mode
BatFan	Battery Fan	Relay is used for automatic battery compartment ventilation (switching the fan)

Function/ Settings	Meaning	Function Description
AcidCir	Acid Circulation	Relay is used for automatic acid circulation (switching of electrolyte circulation pump)



*You can only assign one function to each relay. In case the devices are connected in parallel the relays of the slaves are configured by the master.*



*The relays have both open and close functionality.*

*Except for "Error" all relay functions are designed to close, i.e. the contact is closed in case the relay is activated. The exception "Error" results from the fact that the relay opens when activated. This means that the relay is normally activated and opens the contact. Only in case of a failure it is deactivated and closes the contact (and thus e. g. activates a warning light).*



*In case of failure the relays change to safe state, i. e. they are deactivated.*

## 16 Multicluster Operation

The connection and all parameters required for Multicluster operation with Sunny Island 5048 are described in a separate document.

# 17 Sunny Boy

The following section provides information for connecting and configuring the Sunny Boy inverter in stand-alone grid systems. You can use the following products with a Sunny Island 5048 at the time this documentation was printed:

- Sunny Boy inverters (for feeding in from PV systems):  
SB 700 / SB 1100 / SB 1100LV / SB 1700 / SB 2500 / SB 2800i / SB 3000 / SB 3300 / SB 3800 / SMC 5000 / SMC 5000A / SMC 6000 / SMC 6000A / SMC 6000TL / SMC 7000TL / SMC 8000TL
- Windy Boy inverters (for feeding in from wind turbines or hydropower systems):  
WB 1100 / WB 1700 / WB 2500 / WB 2800i / WB 3000 / WB 3300 / WB 3800 / WB 6000
- all Hydro-Boy inverters (for feeding in from fuel cell systems)

## 17.1 Connection to the Stand-alone Grid

**Ensure that the entire connection area of the Sunny Island 5048 is free of voltage before installing the Sunny Boy inverter. Please pay attention to section 3 "Safety Instructions" (Page 21).**



- Connect the Sunny Boy inverter to the grid in accordance with the Sunny Boy installation manual.
- Wire the AC sub-distribution unit to the AC1 output terminals of the Sunny Island 5048.

*A special configuration of the Sunny Island 5048 concerning the usage of Sunny Boy inverters is not necessary any more (this special configuration is known from the Sunny Island 3324/4248).*



- You must also set according parameters in the Sunny Boy to suit a stand-alone grid so that it works properly together with the Sunny Island 5048. The required values for these settings are described in the following section .

For a PV generator with an installed capacity of 5 kWp, combined with two Sunny Boy inverters (2500 W each), a battery capacity of at least 500 Ah is required.



*In case a system is in a so-called "islanding situation" (power of the Sunny Boys is exactly the load power required), the Sunny Boy is still active in the stand-alone grid until the respective load varies by more than 0.2 kW, even if the Sunny Island 5048 is disconnected.*



*Sunny Boys do not have an anti-islanding in the stand-alone grid!*

## 17.2 Setting the Stand-alone Grid Parameters

Controlled battery charging is required in a stand-alone grid. Sunny Boy inverters can reduce their feed-in power for this reason. This task is performed by a "Power adjustment via frequency" system (see section 17.3 "Frequency Shift Power Control (FSPC)" (Page 129)).

To activate this adjustment, you must configure the Sunny Boy as follows:



For changing the grid relevant parameters in the Sunny Boy inverter a special access code, the installer code, is required. Contact the Sunny Island Hotline at +49 561 95 22 399 or by email: [Sunny\\_Island.hotline@SMA.de](mailto:Sunny_Island.hotline@SMA.de) in order to obtain this personal code.



To set the parameters, a communication channel to the Sunny Boy is required. Install one of these three variants:

- PC/Laptop with the Sunny Data software and with service cable for data transfer (SMA order number: "USBPBS-11"-USB-Service-Interface)
- Sunny Boy Control
- Sunny WebBox

For further information on communication refer to section 6.5 "Interface for External Communication" (Page 51).

1. Establish communication with the Sunny Boy.
2. Go to the parameter settings.
3. Set the parameter "Default" to "Off-Grid" (stand-alone grid).



When ordering Sunny Boys for a stand-alone grid, they are already configured with stand-alone grid settings at the factory. Other changes are not required.

The "Off-Grid" parameter setting automatically sets the following Sunny Boy parameters to the following values:

No.	Parameter	Unit	Value
1	I-NiTest	mA	Off (MSD = 0)
2	Uac-Min	V	180
3	Uac-Max	V	260
4	Fac-delta- Lower range, where the Sunny Boy is active, based on $f_0$	Hz	+ 4.5 (starting from base frequency $f_0$ )



No.	Parameter	Unit	Value
5	Fac-max+ Upper range, where the Sunny Boy is active, based on $f_0$	Hz	+ 4.5 (starting from base frequency $f_0$ )
6	dFac-Max max. rate of change	Hz/s	4
7	Fac-start delta Frequency raise based on $f_0$ , where the power control via frequency begins.	Hz	+ 1 (starting from base frequency $f_0$ )
8	Fac-Limit delta Frequency raise based on $f_0$ , where the power control via frequency ends. The power of the Sunny Boy is 0 W.	Hz	2 (starting from base frequency $f_0$ )

This completes the stand-alone grid parameter settings for the Sunny Boy.

*If Sunny Boy inverters are operated together with Sunny Island 5048 inverters at a communication bus, the "250.06 ComBaud" parameter of the Sunny Island 5048 must be set to "1200" (default).*



*The Sunny Island 5048 only communicates via the SMA-Net protocol, Sunny-Net is not supported.*

## 17.3 Frequency Shift Power Control (FSPC)

This section describes how the power adjustment via frequency "Frequency Shift Power Control (FSPC)" functions.

If Sunny Boy inverters are connected to the AC side of the stand-alone grid, the Sunny Island 5048 must be able to limit their output power. This situation can occur when (e.g.) the batteries of the Sunny Island 5048 are fully charged and the (solar) power available from the PV generator exceeds the power required by the connected loads.

To prevent the excess energy from overcharging the batteries, the Sunny Island 5048 recognizes this situation and changes the frequency of the AC output. This frequency adjustment is analyzed by the Sunny Boy. As soon as the grid frequency increases beyond the value specified by "Fac-Start delta" the Sunny Boy limits its output power accordingly.

This function is shown in the following figure:

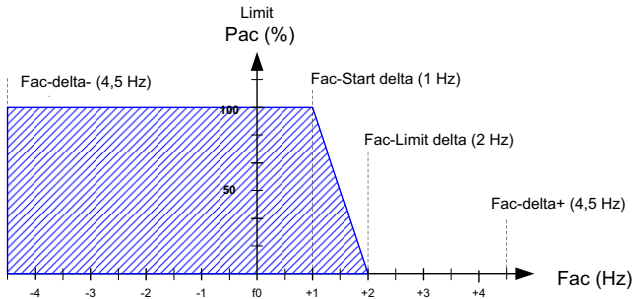

The terms in the figure have the following meaning:

- $f_0$  refers to the nominal frequency of the stand-alone grid
- Fac-delta- and Fac-delta+ refer to the max. range in which the Sunny Boy is active, based on  $f_0$
- Fac-start delta refers to the frequency rise based on  $f_0$ , where the power control via frequency begins.
- Fac-Limit delta the frequency rise based on  $f_0$ , where the power control via frequency ends. The power of the Sunny Boy is 0 W.

In case the value is below the Fac-delta limit and/or above the Fac-delta+ limit, the Sunny Boys are disconnected from the grid.

When FSPC is activated and the diesel generator is operating in the stand-alone grid, the diesel generator determines the frequency and the Sunny Boys react to changes in the generator frequency. Generators normally operate at 50Hz under load. For this reason, in most cases the Sunny Boys will deliver their entire power to the stand-alone grid, even when the generator is running.



*If the current battery voltage ( $V_{Bat}$ ) is higher than the nominal battery voltage ( $V_{Bat, nom}$ ) and is also to be synchronized with an external source (generator), the Sunny Island 5048 temporarily increases the frequency and disconnects the Sunny Boys using the frequency shutdown method (overfrequency). Afterwards, it synchronizes with the generator.*

## 18 Maintenance and Care

The Sunny Island 5048 has been constructed for low maintenance. Thus, the necessary work is limited to only a few points:

### 18.1 Housing

Check that the housing of the Sunny Island 5048 is mechanically sound. If damage (e.g. cracks, holes, missing covers) endangers the operating safety, the Sunny Island 5048 must be deactivated immediately.

Larger particles of dirt should be removed from the device with a soft brush, or similar object. Dust can be removed with a damp cloth. Solvents, abrasives or corrosive liquids must not be used.

### 18.2 Cleaning the Fans

The cleaning intervals depend on the ambient conditions. If the fans are covered with loose dust, you can clean them with the aid of a vacuum cleaner (recommended) or a soft brush/swab. Clean the fans only when at a standstill. If it is necessary to replace the fans, please contact your installer.

### 18.3 Display

It is best to clean the control elements with a soft, damp cloth. Solvents, abrasives or corrosive liquids must not be used.

**Take care not to accidentally press the membrane keys during cleaning. Clean the membrane keys only when the device is off.**



### 18.4 Functioning

Check regularly whether error messages are present. If an error message is displayed, for which you cannot identify any apparent cause, the stand-alone grid must be inspected by an installer. To ensure optimal operation, the operator should regularly check the entries in the error list of the Sunny Island 5048 at short intervals (monthly, or even weekly), especially during the first months after commissioning. This can help to discover hidden faults in the installation or errors in the configuration.

## 18.5 Battery



**A battery must be checked and maintained regularly. In this regard, observe the battery manufacturer's specifications.**

## 18.6 Disposal

Dispose of the Sunny Island 5048 at the end of its service life in accordance with the disposal regulations for electronic scrap which apply at the installation site at that time. Alternatively, send it back to **SMA Technologie AG** with shipping paid by sender, and labeled "FOR DISPOSAL" (see section 24 "Contact" (Page 181)).

# 19 Parameter Lists

The following diagram provides an overview of the menu structure.

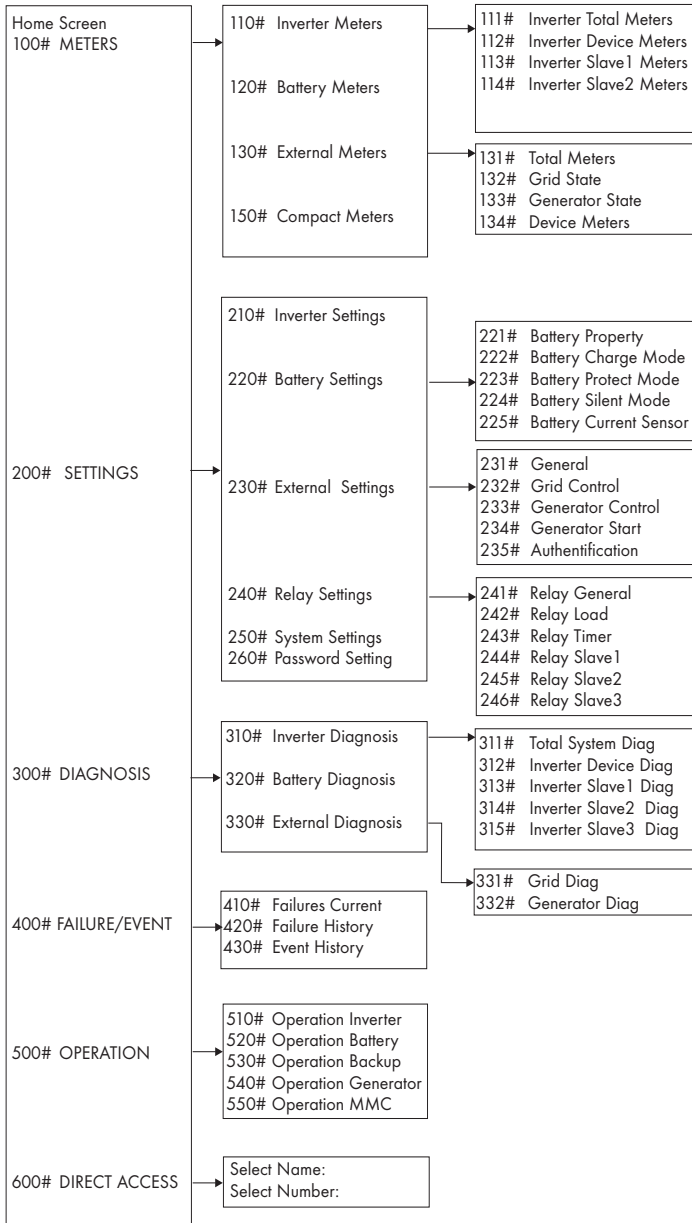

Only parameters in the menu branches "200-Settings" and "500-Operation" can be changed. All other values are only displayed in the display of the Sunny Island 5048. The cells with a grey background in the following tables show all menu items that can only be changed after entering the installer password.



*Depending on the system configuration set, single menu items can be missing. In case your system includes only one Sunny Island 5048 all menus relating to slaves are omitted.*



*Proceed carefully when setting parameters! Incorrect settings can lead to faulty operation of the inverter.*

*Take note of the original values of all parameters that you change.*



*The "510.02 ParaSto" allows all the current parameter settings to be saved on the MMC/SD card. This is especially useful if you wish to try out new settings.*



*Once the system is working optimally, i. e. the selected settings have proven effective, you should use the "510.02 ParaSto" parameter to save the stored values on the MMC/SD card.*

*Now new settings can be made. In case these settings shall be rejected, use the "510.08 ParaLod" parameter to restore the former state.*



*The parameter names used are based on the international IEC 61850-7-4 and 61400-25 Standards.*

## 19.1 Display Values

### 110# Inverter Meters

Menu No.	Parameter No.	Parameter Name	Range/Unit	Description
<b>111 Inverter Total Meters</b>				
111	01	TotInvPwrAt	kW	total active power of inverter (cluster)
111	02	TotInvCur	A	total inverter current (cluster)
111	03	TotInvPwrRt	kVAr	total reactive power of inverter (cluster)

Menu No.	Parameter No.	Parameter Name	Range/ Unit	Description
<b>112 Inverter Device Meters</b>				
112	01	InvOpStt	Standby Run EmCharge Error Startup KickOff	Operating mode = standby = operation = emergency charge = error = change standby -> operation = Sunny Boys are disconnected by frequency increase
112	02	runInvPwrAt	kW	active power on the inverter
112	03	InvVtg	V	voltage on the inverter
112	04	InvCur	A	inverter current
112	05	InvFrq	Hz	frequency on the inverter
112	06	InvPwrRt	kVAr	Reactive power on the inverter
112	07	Rly1Stt	Off On	state of relay 1
112	08	Rly2Stt	Off On	state of relay 2
<b>113 Inverter Slave1 Meters</b>				
113	01	InvOpSttSlv1	Standby Run EmCharge Error Startup KickOff	operating mode of slave1 = standby = operation = emergency charge = error = change standby -> operation = Sunny Boys are disconnected by frequency increase
113	02	InvPwrAtSlv1	kW	active power of inverter on slave 1
113	03	InvVtgSlv1	V	inverter voltage on slave 1
113	04	InvCurSlv1	A	inverter current on slave 1
113	05	InvPwrRtSlv1	kVAr	reactive power of inverter on slave 1
113	06	Rly1SttSlv1	Off On	state of relay 1 on slave 1
113	07	Rly2SttSlv1	Off On	state of relay 2 on slave 1
<b>114 Inverter Slave2 Meters</b>				
114	01	InvOpSttSlv2	Standby Run EmCharge Error Startup KickOff	Operating mode of slave2 = standby = operation = emergency charge = error = change standby -> operation = Sunny Boys are disconnected by frequency increase

Menu No.	Parameter No.	Parameter Name	Range/Unit	Description
114	02	InvPwrAtSlv2	kW	active power of inverter on slave2
114	03	InvVtgSlv2	V	inverter voltage on slave2
114	04	InvCurSlv2	A	inverter current on slave2
114	05	InvPwrRtSlv2	kVAr	reactive power of inverter on slave
114	06	Rly1SttSlv2	Off On	state of relay 1 on slave2
114	07	Rly2SttSlv2	Off On	state of relay 2 on slave2
<b>115 Inverter Slave3 Meters</b>				
115	01	InvOpSttSlv3	Standby Run EmCharge Error Startup KickOff	Operating mode of slave3 = standby = operation = emergency charge = error = change standby -> operation = Sunny Boys are disconnected by frequency increase
115	02	InvPwrAtSlv3	kW	active power of inverter on slave3
115	03	InvVtgSlv3	V	inverter voltage on slave3
115	04	InvCurSlv3	A	inverter current on slave3
115	05	InvPwrRtSlv3	kVAr	reactive power of inverter on slave3
115	06	Rly1SttSlv3	Off On	state of relay 1 on slave3
115	07	Rly2SttSlv3	Off On	state of relay 2 on slave3

## 120# Battery Meters

Menu No.	Parameter No.	Parameter Name	Range/Unit	Description
120	01	BatSoc	%	state of charge of battery (SOC)
120	02	BatVtg	V	battery voltage
120	03	BatChrgVtg	V	nominal value of charging voltage
120	04	ApfTmRmg	hhmmss	remaining absorption time (hhmmss)
120	05	BatChrgOp	Boost, Full, Equalize Float Silent	Active charging process = boost charge = full charge = equalization charge = maintenance charge = silent mode
120	06	TotBatCur	A	total battery current of cluster



Menu No.	Parameter No.	Parameter Name	Range/Unit	Description
120	07	BatTmp	degC	battery temperature
120	08	RmgTmFul	d	remaining time until next full charge
120	09	RmgTmEqu	d	remaining time until next equalizing charge
120	10	AptPhs	Off On	absorption phase is active
120	11	BatSocErr	%	estimated error of state of charge

## 130# External Meters

Menu No.	Parameter No.	Parameter Name	Range/Unit	Description
<b>131 Total Meters</b>				
131	01	TotExtPwrAt	kW	total active power of external source
131	02	TotExtCur	A	total current of external source
131	03	TotExtPwrRt	kVAr	total reactive power of external source
<b>132 Grid State</b>				
132	01	GdRmgTm	hhmmss	Restlaufzeit des Parameters GdValTm (Netz-Gut-Zeit) (hhmmss)
<b>133 Generator State</b>				
133	01	GnDmdSrc	None Bat Lod Tim Run1h, Start ExtSrcReq	source for generator request = no request = dependent on battery state of charge = load-dependent = time-controlled = for 1 hour = manually started = request of external source
133	02	GnStt	Off Ready Warm Connect Run Retry Disconnect Cool Lock Fail FailLock	generator state = disconnected = waiting for request (ready) = warming-up = connecting = operation = restart = disconnecting = cooling down = locked after operation = error = locked after erro
133	03	GnRmgTm	hhmmss	remaining operating time of generator (minimum operating time) (hhmmss)
133	04	GnRnStt	Off On	state generator response on master (Dig-In)

Menu No.	Parameter No.	Parameter Name	Range/Unit	Description
<b>134 Device Meters</b>				
134	01	ExtPwrAt	kW	active power of external source
134	02	ExtVtg	V	voltage of external source
134	03	ExtCur	A	current of external source
134	04	ExtFrq	Hz	frequency of external source
134	05	ExtPwrRt	kVAr	reactive power of external source
<b>135 Slave1 Meters</b>				
135	01	ExtPwrAtSlv1	kW	active power of external source on slave 1
135	02	ExtVtgSlv1	V	voltage of external source on slave 1
135	03	ExtCurSlv1	A	current of external source on slave 1
135	04	ExtPwrRtSlv1	kVAr	reactive power of external source on slave 1
<b>136 Slave2 Meters</b>				
136	01	ExtPwrAtSlv2	kW	active power of external source on slave2
136	02	ExtVtgSlv2	V	voltage of external source on slave2
136	03	ExtCurSlv2	A	current of external source on slave2
136	04	ExtPwrRtSlv2	kVAr	reactive power of external source on slave2
<b>137 Slave3 Meters</b>				
137	01	ExtPwrAtSlv3	kW	active power of external source on slave3
137	02	ExtVtgSlv3	V	voltage of external source on slave3
137	03	ExtCurSlv3	A	current of external source on slave3
137	04	ExtPwrRtSlv3	kVAr	reactive power of external source on slave3

For a detailed description of the "**150# Compact Meters**" menu see section 10.4 "Compact Meters" (Page 72).

## 19.2 Adjustable System Parameters

Parameters marked with **(Stby)** are to be changed only when the Sunny Island 5048 is in standby mode. Once the "ENTER" key is pressed, operating data values can immediately change to their new settings. Incorrect values for these parameters can probably not be corrected quickly enough to avoid potential damage to your system.



The cells with a grey background in the following tables show all menu items that can only be changed after entering the installer password.

All parameters can be set using a connected PC/laptop with the Sunny Data Control software, a Sunny WebBox or a Sunny Boy Control (see section 6.5 "Interface for External Communication" (Page 51)).

### 210# Inverter Settings

Menu No.	Parameter No.	Parameter Name	Range/ Unit	Value	Description
210	01	InvVtgNom	V	230	nominal inverter voltage 230 = 230V_50HZ 220 = 220V_60HZ depending on the setting in QCG
210	02	InvChrgCurMax	A	20	maximum AC charging current
210	03	InvFrqNom	Hz	50	nominal inverter frequency 50 = 230V_50HZ 60 = 220V_60HZ depending on the setting in QCG
210	04	InvVtgMin	V	202	minimum inverter voltage 202 = 230V_50HZ 194 = 220V_60HZ depending on the setting in QCG
210	05	InvVtgMax	V	253	maximum inverter voltage 253 = 230V_50HZ 242 = 220V_60HZ depending on the setting in QCG
210	06	InvFrqMin	Hz	45	minimum inverter voltage 45 = 230V_50HZ 55 = 220V_60HZ depending on the setting in QCG
210	07	InvFrqMax	Hz	55	maximum inverter voltage 55 = 230V_50HZ 65 = 220V_60HZ depending on the setting in QCG

**220# Battery Settings**

Menu No.	Parameter No.	Parameter Name	Range/ Unit	Default Value	Description
<b>221 Battery Property</b>					
221	01	BatTyp	VRLA FLA NiCd	VRLA	Battery type: = valve regulated lead acid = flooded lead acid = nickel cadmium can only be changed in QCG
221	02	BatCpyNom	Ah	100	nominal battery capacity (C10) can only be changed in QCG
221	03	BatVtgNom	V	48	nominal battery voltage 48 = VRLA 48 = FLA 45.6 = NiCd can only be changed in QCG
221	04	BatTmpMax	degC	40	maximum battery temperature
221	05	BatTmpStr	degC	35	battery restart temperature after stop due to overtemperature
<b>222 Battery Charge Mode</b>					
222	01	BatChrgCurMax	A	61	battery charging current limit (depending on nominal battery capacity, 61 % of nominal battery capacity (221.02)) depending on the setting in QCG
222	02	ApiTmBoost	min	120	absorption time for boost charge 120 = VRLA 90 = FLA 300 = NiCd depending on the setting in QCG
222	03	ApiTmFul	h	5	absorption time for full charge 5 = VRLA 5 = FLA 7 = NiCd depending on the setting in QCG
222	04	ApiTmEqu	h	10	absorption time for equalization charge 10 = VRLA 10 = FLA 10 = NiCd depending on the setting in QCG
222	05	CycTmFul	d	14	full charge cycle time
222	06	CycTmEqu	d	180	equalization charge cycle time

Menu No.	Parameter No.	Parameter Name	Range/ Unit	Default Value	Description
222	07	ChrgVtgBoost	V	2.4	Nominal value of cell voltage for boost charge 2.4 = VRLA 2.55 = FLA 1.65 = NiCd depending on the setting in QCG
222	08	ChrgVtgFul	V	2.4	nominal value of cell voltage for full charge 2.4 = VRLA 2.5 = FLA 1.65 = NiCd depending on the setting in QCG
222	09	ChrgVtgEqu	V	2.4	nominal value of cell voltage for equalization charge 2.4 = VRLA 2.5 = FLA 1.65 = NiCd depending on the setting in QCG
222	10	ChrgVtgFlo	V	2.25	nominal value of cell voltage for float charge 2.25 = VRLA 2.25 = FLA 1.55 = NiCd depending on the setting in QCG
222	11	BatTmpCps	mV/degC	4.0	battery temperature compensation 4.0 = VRLA 4.0 = FLA 0.0 = NiCd depending on the setting in QCG
222	12	AutoEquChrgEna	Disable Enable	Enable	activate automatic equalization charge
<b>223 Battery Protect Mode</b>					
223	01	BatPro1TmStr	hhmmss	220000	time for starting battery preserve mode level 1
223	02	BatPro1TmStp	hhmmss	060000	time for stopping battery preservation mode level 1
223	03	BatPro2TmStr	hhmmss	170000	Time for starting battery preservation mode level 2
223	04	BatPro2TmStp	hhmmss	090000	Time for stopping battery preserve mode level 2
223	05	BatPro1Soc	%	20	SOC limit for preservation mode level 1
223	06	BatPro2Soc	%	15	SOC limit for preservation mode level 2
223	07	BatPro3Soc	%	10	SOC limit for preservation mode level 3
<b>224 Battery Silent Mode</b>					

Menu No.	Parameter No.	Parameter Name	Range/ Unit	Default Value	Description
224	01	SilentEna	Disable Enable	Disable	allows silent mode on the grid
224	02	SilentTmFlo <b>(Stby)</b>	h	3	max. time for float charge until change to silent
224	03	SilentTmMax <b>(Stby)</b>	h	12	max. time for silent mode until change to float

Menu No.	Parameter No.	Parameter Name	Range/ Unit	Default Value	Description
<b>225 Battery Current Sensor</b>					
225	01	BatCurSnsTyp	None 60mV 50mV	None	current sensor type
225	02	BatCurGain60	A/60mV	100	external battery current sensor 60mV type
225	03	BatCurGain50	A/50mV	100	external battery current sensor 50mV type
225	04	BatCurAutoCal	Start		automatic calibration of the external battery current sensor

## 230# External Settings

Menu No.	Parameter No.	Parameter Name	Range/ Unit	Default Value	Description
<b>231 General</b>					
231	01	PvFeedTmStr	hhmmss	040000	start of PV feed-in
231	02	PvFeedTmStp	hhmmss	220000	stop of PV feed-in
231	03	ExtLkTm	min	20	locking time after reverse power and/or relay protection
231	04	AcSrcFrqDel	Hz	4.8	frequency increase for disconnecting AC feed-in generators
231	09	ExtSrc	PvOnly Gen Grid GenGrid	PvOnly	generator and grid operating mode = only PV = grid = external sources = grid and external sources
231	13	PvInst	Disable Enable	Disable	PV installed
231	14	TotPvPwr	kW	7.5	total PV power installed
231	15	ClstPwrNom	kW	5	nominal power of the cluster
<b>232 Grid Control</b>					
232	01	GdVtgMin *	V	184	minimum grid voltage 184 = 230V_50HZ 194 = 220V_60HZ depending on the setting in QCG
232	02	GdVtgMax *	V	264.5	maximum grid voltage 264.5 = 230V_50HZ 242 = 220V_60HZ depending on the setting in QCG
232	03	GdCurNom	A	16	nominal grid current

Menu No.	Parameter No.	Parameter Name	Range/ Unit	Default Value	Description
232	04	GdFrqNom	Hz	50	nominal frequency 50 = 230V_50HZ 60 = 220V_60HZ depending on the setting in QCG
232	05	GdFrqMin *	Hz	47.5	minimum grid frequency 47.5 = 230V_50HZ 59.3 = 220V_60HZ depending on the setting in QCG
232	06	GdFrqMax *	Hz	50.2	maximum grid frequency 50.2 = 230V_50HZ 60.5 = 220V_60HZ depending on the setting in QCG
232	07	GdVldTm	sec	30	minimum time required for grid (voltage and frequency) to be within permissible range for connection 30 = 230V_50HZ 300 = 220V_60HZ depending on the setting in QCG
232	08	GdMod	GridCharge GridFeed	GridCharge	grid interface
232	09	GdRvPwr	W	100	permissible grid reverse power (active power)
232	10	GdRvTm	sec	5	permissible time for grid reverse power
232	18	GdVtgIncProEna	Disable Enable	Disable	allows voltage rise protection
232	19	GdVtgIncPro	V	253	voltage rise protection limit 253 = 230V_50HZ 242 = 220V_60HZ depending on the setting in QCG
232	21	Country	Adjusted Other GER_VDE0 126_1_1 SP_RD1663		country selection
<b>233 Generator Control</b>					
233	01	GnVtgMin	V	172.5	minimum generator voltage
233	02	GnVtgMax	V	250	maximum generator voltage
233	03	GnCurNom	A	16	nominal generator current
233	04	GnFrqNom	Hz	50	nominal generator frequency (at nominal load) 50 = 230V_50HZ 60 = 220V_60HZ depending on the setting in QCG



Menu No.	Parameter No.	Parameter Name	Range/ Unit	Default Value	Description
233	05	GnFrqMin	Hz	44.64	minimum generator frequency 44.64 = 230V_50HZ 50 = 220V_60HZ depending on the setting in QCG
233	06	GnFrqMax	Hz	60	maximum generator frequency 60 = 230V_50HZ 70 = 220V_60HZ depending on the setting in QCG
233	07	GnStrMod	Manual Autostart GenMan	Autostart	generator interface
233	08	GnOpTmMin	min	15	minimum generator operating time
233	09	GnStpTmMin	min	15	minimum generator stop time
233	10	GnCoolTm	min	5	generator cooling-off time
233	11	GnErrStpTm	h	1	generator stop time for generator fault
233	12	GnWarmTm	sec	60	warm-up time(minimum time required for generator voltage and frequency to be within permissible range for connection)
233	13	GnRvPwr	W	100	permissible generator reverse power (active power)
233	14	GnRvTm	sec	30	permissible time for reverse power/reverse current
233	15	ExtCtlMod	Cur CurFrq	Cur	ext. (gen/grid) controller (current or frequency)
<b>234 Generator Start</b>					
234	01	GnAutoEna	Off On	On	activate generator autostart
234	02	GnAutoStr		3	number of autostarts
234	03	GnSocTm1Str	%	40	SOC limit for switching on generator for time 1
234	04	GnSocTm1Stp	%	80	SOC limit for switching off generator for time 1
234	05	GnSocTm2Str	%	40	SOC limit for switching on generator for time 2
234	06	GnSocTm2Stp	%	80	SOC limit for switching off generator for time 2
234	07	GnTm1Str	hhmmss	0	time 1 for generator request (begin time 1, end time 2)(hhmmss)
234	08	GnTm2Str	hhmmss	0	time 2 for generator request (begin time 2, end time 1)(hhmmss)

Menu No.	Parameter No.	Parameter Name	Range/ Unit	Default Value	Description
234	09	GnPwrEna	Off On	Off	activates generator request as a result of power
234	10	GnPwrStr	kW	4	activates generator as a result of power limit
234	11	GnPwrStp	kW	2	deactivates generator as a result of power limit
234	12	GnPwrAvgTm	sec	60	average time for power-related generator starts



Parameters designated with \* are safety-related grid monitoring parameters. To change the SMA grid guard parameters, you must enter your personal SMA grid guard password (Inst.-Code). Call the SMA hotline to obtain your personal SMA grid guard password.

## 240# Relay Settings

Menu No.	Parameter No.	Parameter Name	Range/ Unit	Default Value	Description
<b>241 Relay General</b>					
241	01	Rly1Op	Off On AutoGn  AutoLodExt  AutoLod1Soc AutoLod2Soc  Tmr1 Tmr2 AptPhs GnRn ExtVfOk  GdOn Error Warm Run BatFan AcidCir MSD 1 MSD 2	AutoGn	Function of relay 1 = switched off = switched on = automatic generator connection = automatic disconnection of loads, connection only if external sources are available = automatic connection/disconnection of loads due to SOC1 = automatic connection/disconnection of loads due to SOC2 = programmable timer 1 = programmable timer 1 = absorption phase is active = generator is running = ext. voltage and frequency in permissible range = ext. grid is connected = error = warm-up = operation = battery room fan = electrolyte pump (= currently has no function) (= currently has no function)
241	02	Rly2Op	see 241.01	AutoLodExt	Function of relay 2 for details see 241.01

Menu No.	Parameter No.	Parameter Name	Range/ Unit	Default Value	Description
<b>242 Relay Load</b>					
242	01	Lod1SocTm1Str	%	30	SOC limit for load shedding 1 start for t1
242	02	Lod1SocTm1Stp	%	50	SOC limit for load shedding 1 stop for t1
242	03	Lod1SocTm2Str	%	30	SOC limit for load shedding 1 start for t2
242	04	Lod1SocTm2Stp	%	50	SOC limit for load shedding 1 stop for t2
242	05	Lod1Tm1Str	hhmmss	0	load shedding 1 time 1 (beginning time 1, end time 2) (hhmmss)
242	06	Lod1Tm2Str	hhmmss	0	load shedding 1 time 2 (beginning time 2, end time 1) (hhmmss)
242	07	Lod2SocTm1Str	%	30	SOC limit for load shedding 2 start for t1
242	08	Lod2SocTm1Stp	%	50	SOC limit for load shedding 2 stop for t1
242	09	Lod2SocTm2Str	%	30	SOC limit for load shedding 2 start for t2
242	10	Lod2SocTm2Stp	%	50	SOC limit for load shedding 2 stop for t2
242	11	Lod2Tm1Str	hhmmss	0	load shedding 2 time1 (beginning time1, end time2) (hhmmss)
242	12	Lod2Tm2Str	hhmmss	0	load shedding 2 time2 (beginning time2, end time1) (hhmmss)
<b>243 Relay Timer</b>					
243	01	RlyTmr1StrDt	yyyymmdd	20060101	start date timer 1 (yyyymmdd)
243	02	RlyTmr1StrTm	hhmmss	0	start time for relay control timer 1 (hhmmss)
243	03	RlyTmr1Dur	hhmmss	0	run time for relay control timer 1 (hhmmss)
243	04	RlyTmr1Cyc	Single Dayly Weekly	Single	repeated cycle time for timer 1
243	05	RlyTmr2StrDt	yyyymmdd	20060101	start date timer 2 (yyyymmdd)
243	06	RlyTmr2StrTm	hhmmss	0	start time for relay control timer 2 (hhmmss)
243	07	RlyTmr2Dur	hhmmss	0	run time for relay control timer 2 (hhmmss)

Menu No.	Parameter No.	Parameter Name	Range/ Unit	Default Value	Description
243	08	RlyTmr2Cyc	Single Daily Weekly	Single	repeated cycle time for timer 2
<b>244 Relay Slave1</b>					
244	01	Rly1OpSlv1	see 241.01	AutoGn	function of relay 1 on slave1 for details see 241.01
244	02	Rly2OpSlv1	see 241.01	AutoLodExt	function of relay 2 on slave1 for details see 241.01
<b>245 Relay Slave2</b>					
245	01	Rly1OpSlv2	see 241.01	AutoGn	function of relay 1 on slave2 for details see 241.01
245	02	Rly2OpSlv2	see 241.01	AutoLodExt	function of relay 2 on slave2 for details see 241.01
<b>246 Relay Slave3</b>					
246	01	Rly1OpSlv3	see 241.01	AutoGn	function of relay 1 on slave3 for details see 241.01
246	02	Rly2OpSlv3	see 241.01	AutoLodExt	function of relay 2 on slave 3, for details see 241.01

## 250# System Settings

Menu No.	Parameter No.	Parameter Name	Range/ Unit	Default Value	Description
250	01	AutoStr (Stby)		3	autostart (0=autostart deactivated)
250	02	Dt	yyyymmdd		date (yyyymmdd)
250	03	Tm	hhmmss		time (hhmmss)
250	04	BeepEna	Off On	On	activates beeper
250	05	ClstCfg			cluster configuration depending on the setting in QCG (read-only)
250	06	ComBaud	1200 4800 9600 19200	1200	baud rate interface
250	07	ComTrf	Serial CAN	Serial	interface
250	08	ComPtl	SMA-Data CAN CAN-Open	SMA-Data	interface protocol
250	09	ComAdr			interface address

Menu No.	Parameter No.	Parameter Name	Range/Unit	Default Value	Description
250	10	SleepEna	Disable Enable	Enable	allows sleep mode
250	11	AfraEna	Disable Enable	Enable	activation of Automatic Frequency Adjustment (AFRA)

For a detailed description of the "**260 „Password Setting**" menu see section 10.5 "Entering the Installer Password" (Page 74).

## 19.3 Diagnostics

### 310# Inverter Diagnosis

Menu No.	Parameter No.	Parameter Name	Range/Unit	Description
<b>311 Total System Diag</b>				
311	01	EgyCntIn	kWh	energy absorbed
311	02	EgyCntOut	kWh	energy fed
311	03	EgyCntTm	h	energy metering run time
<b>312 Inverter Device Diag</b>				
312	01	Adr	Master Slave1 Slave2 Slave3	device address (type) depending on the setting in QCG
312	02	FwVer		BFR firmware version
312	03	SN		serial number
312	04	OnTmh	h	operating hours
312	05	ClstCfgAt	1Phase1 1Phase2 1Phase3 1Phase4 2Phase2 3Phase 2Phase4	set cluster configuration depending on the setting in QCG
312	06	OpStt	Operating Warning Failure	operating mode (device)
312	07	CardStt	Off Operational Mount OutOfSpace  BadFileSys Incomp Parameter ParamFailed WriteLogData WriteLogFailed	MMC/SD card status message: = no card in the Sunny Island 5048 = in operation = card initializing = insufficient memory capacity (on card or in main directory) = incorrect file system = incompatible card = parameter- update is active = error during parameter update = write log data on card = error when writing log data on card
312	08	FwVer2		DSP firmware version
312	09	FwVer3		BFR boot loader
312	10	FwVer4		DSP boot loader
<b>313 Inverter Slave1 Diag</b>				
313	01	FwVerSlv1		BFR firmware version on slave 1
313	02	SNSlv1		serial number on slave 1

Menu No.	Parameter No.	Parameter Name	Range/Unit	Description
313	03	OnTmhSlv1	h	operating hours of slave 1
313	04	PhSlv1	L1 L2 L3	phase position on slave 1
313	05	OpSttSlv1	Operating Warning Failure	operating mode (device) of slave 1
313	06	FwVer2Slv1		DSP firmware version on slave 1
313	07	FwVer3Slv1		BFR boot loader on slave 1
313	08	FwVer4Slv1		DSP boot loader on slave 1
<b>314 Inverter Slave2 Diag</b>				
314	01	FwVerSlv2		BFR firmware version on slave2
314	02	SNSlv2		serial number on slave2
314	03	OnTmhSlv2	h	operating hours of slave2
314	04	PhSlv2	L1 L2 L3	phase position on slave 2
314	05	OpSttSlv2	Operating Warning Failure	operating mode (device) on slave2
314	06	FwVer2Slv2		DSP firmware version on slave2
314	07	FwVer3Slv2		BFR boot loader on slave 2
314	08	FwVer4Slv2		DSP boot loader on slave 2
<b>315 Inverter Slave3 Diag</b>				
315	01	FwVerSlv1		BFR firmware version on slave3
315	02	SNSlv1		serial number on slave3
315	03	OnTmhSlv1	h	operating hours of slave3
315	04	PhSlv1	L1 L2 L3	phase position on slave 3
315	05	OpSttSlv1	Operating Warning Failure	operating mode (device) on slave3
315	06	FwVer2Slv1		DSP firmware version on slave3
315	07	FwVer3Slv1		BFR boot loader on slave 3
315	08	FwVer4Slv1		DSP boot loader on slave 3

## 320# Battery Diagnosis

Menu No.	Parameter No.	Parameter Name	Range/Unit	Description
320	01	Soh	%	state of health (SOH), ratio of current capacity and nominal value
320	02	StatTm	d	statistics counter run time
320	03	ChrgFact		charging factor
320	04	BatEgyCntIn	kWh	energy counter for battery charge
320	05	BatEgyCntOut	kWh	energy counter for battery discharge
320	06	AhCntIn	Ah	counter for battery charging ampere hours
320	07	AhCntOut	Ah	counter for battery discharging ampere hours
320	08	BatTmpPkMin	degC	minimum battery temperature
320	09	BatTmpPkMax	degC	maximum battery temperature
320	10	EquChrgCnt		equalization charge counter
320	11	FulChrgCnt		full charge counter
320	12	BatCurOfsErr	A	current offset error of battery current
320	13	OcvPointCnt		counter for open-circuit voltage points
320	14	SilentReq	Off On	silent mode request
320	15	AhCntFul	Ah/100Ah	counter for battery discharging ampere hours since last full charge
320	16	AhCntEqu	Ah/100Ah	counter for battery discharging ampere hours since last equalization charge
320	17	BatVtgPk	V	max. battery voltage applied (SMA)
320	18	BatCurPkIn	A	max. battery current in charging direction (SMA)
320	19	BatCurPkOut	A	max. battery current in discharging direction (SMA)
320	20	SocHgm100	%	frequency scale of state of charge, 100 % > SOC >= 90%
320	21	SocHgm90	%	frequency scale of state of charge, 90 % > SOC >= 80%
320	22	SocHgm80	%	frequency scale of state of charge, 80 % > SOC >= 70%
320	23	SocHgm70	%	frequency scale of state of charge, 70 % > SOC >= 60%
320	24	SocHgm60	%	frequency scale of state of charge, 60 % > SOC >= 50%



Menu No.	Parameter No.	Parameter Name	Range/Unit	Description
320	25	SocHgm50	%	frequency scale of state of charge, 50 % > SOC >= 40%
320	26	SocHgm40	%	frequency scale of state of charge, 40 % > SOC >= 30%
320	27	SocHgm30	%	frequency scale of state of charge, 30 % > SOC >= 20%
320	28	SocHgm20	%	frequency scale of state of charge, 20 % > SOC >= 10%
320	29	SocHgm10	%	frequency scale of state of charge, 10 % > SOC >= 0%
320	30	SocHgm000	%	frequency scale of state of charge, SOC < 0 %
320	31	SocVtgCal	%	re-calibration of state of charge only via open-circuit voltage
320	32	ErrSocVtgCal	%	estimated error of voltage calibrated state of charge
320	33	SocChrgCal	%	re-calibration of state of charge only via full charge
320	34	ErrSocChrgCal	%	estimated error of full charge calibrated state of charge
320	35	OcvGra	Ah/V	rise of open-circuit voltage characteristic curve
320	36	OcvMax	V	max. open-circuit voltage

### 330# External Diagnosis

Menu No.	Parameter No.	Parameter Name	Range/Unit	Description
<b>331 Grid Diag</b>				
331	01	GdEgyCntIn	kWh	energy counter for grid-feed-in
331	02	GdEgyCntOut	kWh	energy counter for power taken from the grid
331	03	GdEgyTmh	h	run time of grid energy counter
331	04	GdOpTmh	h	operating hour counter for grid operation
331	05	GdCtcCnt		counter for grid connections
331	06	ToiTmh	h	feed-in hours
<b>332 Generator Diag</b>				
331	01	GnEgyCnt	kWh	generator energy counter
331	02	GnEgyTm	h	run time of generator energy counter
331	03	GnOpTmh	h	operating hour counter for generator

<b>Menu No.</b>	<b>Parameter No.</b>	<b>Parameter Name</b>	<b>Range/Unit</b>	<b>Description</b>
331	04	GnStrCnt		number of generator starts

## 19.4 Events, Warnings and Failures (History)

Events and failure messages [410# (Failures Current), 420# (Failure History) and 430# (Event History)] are described in section 20.5 "Display of Failures and Events" (Page 158)).

## 19.5 Function in Operation

### 510# Operation Inverter

Menu No.	Parameter No.	Parameter Name	Range/Unit	Default Value	Description
510	01	InvRs <b>(Stby)</b>	Restart	–	triggers inverter reset
510	02	ParaSto	Set1 Set2	–	saves parameter settings = file 1 = file 2
510	03	InvTmOpEna	Disable Enable	Disable	activates time-controlled inverter operation
510	04	InvTmOpStrDt	yyyymmdd	20060101	start date of time-controlled inverter operation (yyyymmdd)
510	05	InvTmOpStrTm	hhmmss	0	start time of time-controlled inverter operation (hhmmss)
510	06	InvTmOpRnDur	hhmmss	0	run time for time-controlled inverter operation (hhmmss)
510	07	InvTmOpCyc	Single Daily Weekly	Single	repeated cycle time for timer 1
510	08	ParaLod <b>(Stby)</b>	Set1 Set2 Factory	–	loads parameter settings = file 1 = file 2 = factory settings
510	09	CntRs	Inv Bat Gn Gd All	–	resets selected energy counter

### 520# Operation Battery

Menü-Nr.	Parameter No.	Name	Range/Unit	Default	Description
520	01	ManChrgSel	Idle Start Stop	Idle	triggers equalization charge (manually)

## 540# Operation Generator

Menu No.	Parameter No.	Parameter Name	Range/Unit	Default Value	Description
540	01	GnManStr	Auto Stop Start Run 1h,	Auto	manual generator start
540	02	GnAck	Ackn		failure approval for generator failure

## 550# Operation MMC/SD Card

Menü-Nr.	Parameter No.	Name	Range/Unit	Default	Description
550	01	CardFunc	ForcedWrite StoEvtHis StoFailHis		functions for MMC/SD card = forces writing of data = writes event list = writes failure list
550	02	DatLogEna	Off On	On	activates automatic data storage

For a detailed description of the **600 „Direct Access“** menu see section 10.3 "Direct Access" (Page 72).

## 20 Troubleshooting/Problem Solving

In general the Sunny Island 5048 distinguishes between events and failures.

- **Events** describe mode changes or processes which do not require user action (e. g. connection of the generator).
- **Failures** describe modes that are not permitted or are only permitted up to a certain rate. These consist of warnings and failures. These normally require user interaction.

### 20.1 Failure Approval

In case a failure has occurred, the Sunny Island 5048 changes to standby mode, the failure is displayed.

You have to fix the failure cause, confirm the failure with <ENTER> and restart the Sunny Island 5048.

### 20.2 Autostart Handling

The Sunny Island 5048 has an autostart counter, which counts down by 1 with every automatic start. After 10 minutes of normal operation of the Sunny Island 5048 the autostart counter is set back to its original value.

In case another failure occurs with an autostart counter value of 0, the Sunny Island 5048 waits for a time of 10 minutes before restarting. The autostart counter starts again.

The number of autostarts allowed can be set using the "250.01 AutoStr" parameter (in standby).

### 20.3 Master-Slave Handling

Each device detects failures separately and saves them. The slaves transfer these failures to the master. The master collects these failure messages and saves the slave failures as warnings in the master's event history.

*Slave 1 has detected overtemperature. It enters this error in its history and reports it to the master. The master also enters the error as a warning in its failure history ("Menu 420# Failure History").*



The following message is displayed in the bottom line on the master:

**F138 S1 Warning**

If warning 138 is still active on slave 1, the Enter symbol is displayed at the end of the line. After the warning has been acknowledged on the master by pressing the <ENTER> key, it is forwarded to the respective slave.

Display on the Master after acknowledgement:

**F138 S1 Warning**



*The contents of the failure and event recordings are not merged in any way.*

## 20.4 Handling Present Failures During Startup

All present failures are removed in the event history during system startup. A failure that is still present is detected and recorded as present (when still present) or recorded as left (when it has left).

## 20.5 Display of Failures and Events

Each failure and each event has a 3-digit display number, that corresponds with the parameter / measurement value assignment, while events and failures use the same numbering range.

- 1xx - INV - Inverter
- 2xx - BAT - Battery
- 3xx - EXT - Extern
- 4xx - GEN - Generator
- 5xx - GRD - Grid
- 6xx - RLY - Relay
- 7xx - SYS - System



*"F" indicates a failure, "W" a warning and "E" an event.*

*"!" is displayed for set and "C" for clear which indicates if a failure was set or was cleared as long as this is recorded.*

## 20.6 Events

The meanings of the events displayed by the Sunny Island 5048 are described in the following table:

Display number	Description
<b>Category INV</b>	
E101	wait status
E102	startup process

Display number	Description
E103	operation
E104	operating on the generator (at external input)
E105	operating on the grid (at external input)
E106	feed-in grid operation (at external input)
E107	sleep mode (slave in 1-phase systems)
E108	silent mode on the grid
E110	shutting down due to failure
E115	emergency charge
E118	automatic start
E119	manual start (change from standby to operation)
E120	manual stop (change from operation to standby)
<b>Category BAT</b>	
E202	(partial) reset of BMS due to new battery
E203	state change, battery charging algorithm for float (maintenance) charge
E204	state change, battery charging algorithm for boost (rapid) charge
E205	state change, battery charging algorithm for full charge
E206	state change into battery silent mode option
E207	state change, battery charging algorithm for equalization charge
E221	battery preservation mode level 1
E222	battery preservation mode level 2
E223	battery preservation mode level 3
<b>Category GE</b>	
E401	automatic generator start due to defined conditions (battery state of charge, power, time, etc.)
E402	automatic generator stop due to defined conditions (battery state of charge, power, time, etc.)
E403	manual generator start
E404	manual generator stop
E405	manual failure approval of generator failure
<b>Category REL</b>	
E601	relay 1 off
E602	relay 1 on
E603	relay1 on slave 1 off
E604	relay1 on slave 1 on

<b>Display number</b>	<b>Description</b>
E605	relay1 on slave 2 off
E606	relay1 on slave 2 on
E607	relay1 on slave 3 off
E608	relay1 on slave 3 on
E609	transfer relay open
E610	transfer relay closed
E611	transfer relay on slave 1 open
E612	transfer relay on slave 1 closed
E613	transfer relay on slave 2 open
E614	transfer relay on slave 2 closed
E615	transfer relay on slave 3 open
E616	transfer relay on slave 3 closed
E617	relay 2 open
E618	relay 2 closed
E619	relay 2 on slave 1 open
E620	relay 2 on slave 1 closed
E621	relay 2 on slave 2 open
E622	relay 2 on slave 2 closed
E623	relay 2 on slave 3 open
E624	relay 2 on slave 3 closed
E625	digital input OFF (low)
E626	digital input ON (high)
<b>Category SYS</b>	
E705	device start
E706	date, time changed
E707	new system configured in the QCG
E708	part 1 of firmware updated
E709	part 2 of firmware updated
E710	cluster firmware updated
E711	MMC/SD card plugged in



## 20.7 Failure Categories

The Sunny Island 5048 distinguishes between five different levels of failures, each requires different user interaction:

Level	Name	Display	Meaning
1	Warning	Warning	Warning, device continues operation, explicit indication in the "Home Screen" that a warning was recorded.
2	Fault 1	Malfunction	Disturbance that only can be detected in operation, device is deactivated. Restart required. (autostart).
3	Fault 2	Malfunction	Disturbance that can be detected in Standby, device is deactivated. Restart (autostart) is only possible when the failure was detected as left.
4	Failure	Failure	Device failure, device is deactivated. User interaction required (fault removal, approval in the menu, manual restart)
5	Device Failure	Failure	Device is defective, device is deactivated and does not restart. Permanent device disable. Device must be exchanged.

## 20.8 Warnings and Failure messages

The meaning of warnings and failure messages displayed by the Sunny Island 5048 are explained in the following table:

Display number	Level	Description
<b>Category INV</b>		
F109	3	overtemperature on transformer
W110	1	overtemperature on transformer on slave 1
W111	1	overtemperature on transformer on slave 2
W112	1	overtemperature on transformer on slave 3
F113	3	overtemperature on heat sink
W114	1	overtemperature on heat sink on slave 1
W115	1	overtemperature on heat sink on slave 2
W116	1	overtemperature on heat sink on slave 3
F117	2	AC current limitation (short-circuit control active for too long)
W118	1	AC current limitation (short-circuit control active for too long) on slave 1
W119	1	AC current limitation (short-circuit control active for too long) on slave 2
W120	1	AC current limitation (short-circuit control active for too long) on slave 3
F121	3	inverter overvoltage
W122	1	inverter overvoltage on slave 1

Display number	Level	Description
W123	1	inverter overvoltage on slave 2
W124	1	inverter overvoltage on slave 3
W137	1	derating due to temperature (heat sink or transformer)
W138	1	derating due to temperature (heat sink or transformer) on slave 1
W139	1	derating due to temperature (heat sink or transformer) on slave 2
W140	1	derating due to temperature (heat sink or transformer) on slave 3
<b>Category BAT</b>		
F201	3	measuring range of battery voltage exceeded
W202	1	measuring range of battery voltage exceeded on slave 1
W203	1	measuring range of battery voltage exceeded on slave 2
W204	1	measuring range of battery voltage exceeded on slave 3
W206	1	battery overtemperature
W208	3	battery overvoltage (fixed limit for cell voltage)
W210	1	battery overvoltage warning
W211	1	insufficient battery temperature warning
W212	1	high battery temperature warning
<b>Category EXT</b>		
W309	1	relay protection
W310	1	relay protection on slave 1
W311	1	relay protection on slave 2
W312	1	relay protection on slave 3
W314	1	external voltage failure
W315	1	disconnection from grid /generator due to insufficient external voltage
W316	1	disconnection from grid /generator due to insufficient external voltage on slave 1
W317	1	disconnection from grid /generator due to insufficient external voltage on slave 2
W318	1	disconnection from grid /generator due to insufficient external voltage on slave 3
W319	1	disconnection from grid /generator due to excessive external voltage
W320	1	disconnection from grid /generator due to excessive external voltage on slave 1
W321	1	disconnection from grid /generator due to excessive external voltage on slave 2
W322	1	disconnection from grid /generator due to excessive external voltage on slave 3
W323	1	disconnection from grid /generator due to insufficient external frequency
W324	1	disconnection from grid /generator due to insufficient external frequency on slave 1

Display number	Level	Description
W325	1	disconnection from grid /generator due to insufficient external frequency on slave 2
W326	1	disconnection from grid /generator due to insufficient external frequency on slave 3
W327	1	disconnection from grid /generator due to excessive external frequency
W328	1	disconnection from grid /generator due to excessive external frequency on slave 1
W329	1	disconnection from grid /generator due to excessive external frequency on slave 2
W330	1	disconnection from grid /generator due to excessive external frequency on slave 3
W331	1	disconnection from grid /generator due to violation of anti-islanding
W332	1	disconnection from grid /generator due to violation of anti-islanding on slave 1
W333	1	disconnection from grid /generator due to violation of anti-islanding on slave 2
W334	1	disconnection from grid /generator due to violation of anti-islanding on slave 3
W335	1	disconnection from grid/generator due to violation of voltage limits
W336	1	disconnection from grid/generator due to violation of voltage limits on slave 1
W337	1	disconnection from grid/generator due to violation of voltage limits on slave 2
W338	1	disconnection from grid/generator due to violation of voltage limits on slave 3
W339	1	disconnection from grid/generator due to voltage rise protection
W340	1	disconnection from grid/generator due to voltage rise protection on slave 1
W341	1	disconnection from grid/generator due to voltage rise protection on slave 2
W342	1	disconnection from grid/generator due to voltage rise protection on slave 3
F343	1	disconnection from external source
F344	1	disconnection from external source on slave 1
F345	1	disconnection from external source on slave 2
F346	1	disconnection from external source on slave 3
<b>Category GEN</b>		
W401	1	reverse power protection (generator)
<b>Category GRD</b>		
W501	1	grid reverse power suppressed (quick grid disconnection)
W502	1	grid reverse power suppressed (quick grid disconnection) on slave 1
W503	1	grid reverse power suppressed (quick grid disconnection) on slave 2
W504	1	grid reverse power suppressed (quick grid disconnection) on slave 3
<b>Category RLY</b>		
F605	4	generator relay does not open
W606	1	generator relay does not open on slave 1

<b>Display number</b>	<b>Level</b>	<b>Description</b>
W607	1	generator relay does not open on slave 2
W608	1	generator relay does not open on slave 3

Display number	Level	Description
<b>Category SYS</b>		
F702	1	DSP reset
F703	1	timeout during a task
F704	4	DSP invalid calibration
F705	4	watchdog DSP tripped
F706	4	watchdog counter expired (watchdog tripped several times in succession)
W707	1	watchdog counter on slave 1 expired (watchdog tripped several times in succession)
W708	1	watchdog counter on slave 2 expired (watchdog tripped several times in succession)
W709	1	watchdog counter on slave 3 expired (watchdog tripped several times in succession)
F710	4	autostart counter expired (several autostarts in succession)
W713	1	watchdog tripped
F716	3	measuring range of battery voltage exceeded
W717	1	measuring range of battery voltage exceeded on slave 1
W718	1	measuring range of battery voltage exceeded on slave 2
W719	1	measuring range of battery voltage exceeded on slave 3
F720	4	short circuit or defective cable in transformer temperature sensor
F721	4	short circuit or defective cable in heat sink temperature sensor
F722	3	short circuit in battery temperature sensor
F723	3	defective cable in battery temperature sensor
F731	3	failure in cluster configuration
F732	3	failure in address assignment of cluster devices
F733	3	no message from cluster master (only slave)
W734	1	no message from cluster on slave 1
W735	1	no message from cluster on slave 2
W736	1	no message from cluster on slave 3
W738	1	synchronization was not conducted
F739	3	internal device communication BFR-DSP missing
W740	1	internal device communication BFR-DSP missing on slave 1
W741	1	internal device communication BFR-DSP missing on slave 2
W742	1	internal device communication BFR-DSP missing on slave 3
F743	3	internal device communication BFR-DSP missing
W744	1	internal device communication BFR-DSP missing on slave 1

Display number	Level	Description
W745	1	internal device communication BFR-DSP missing on slave 2
W746	1	internal device communication BFR-DSP missing on slave 3
W747	4	short circuit or defective cable in transformer temperature sensor on slave 1
W748	1	short circuit or defective cable in transformer temperature sensor on slave 2
W749	1	short circuit or defective cable in transformer temperature sensor on slave 3
W750	1	short circuit or defective cable in heat sink temperature sensor on slave 1
W751	1	short circuit or defective cable in heat sink temperature sensor on slave 2
W752	1	short circuit or defective cable in heat sink temperature sensor on slave 3
F753	1	invalid system time

## 20.9 Troubleshooting

Questions that may be raised in practice are answered below:

### Why does the Sunny Island 5048 not connect to the running generator?

- Is the generator fuse ok?
- Has the power which may be fed back into the generator during the permissible time ("233.14 GnRvTm" parameter) been exceeded?  
If so, "!" appears in the display. Generator connection is blocked for the time set. Set the "540.02 GnAck" to Ackn.
- If the generator control relay (GnReq) is open:  
Has the generator been started manually ("233.07 GnStrMod" parameter)?  
Change the setting to autostart, if required.

### Why is the display of the Sunny Island 5048 dark and why is nothing displayed?

- Is the DC circuit breaker on the Sunny Island 5048 set to "On" ? In this case the device has switched off to protect the batteries from deep discharge (see also section 13.3 "Charge State/SOC and SOH" (Page 94)). To restart the Sunny Island 5048, see section 9.5 "Restarting the System after Automatic Shutdown" (Page 64).
- The external battery fuse has been triggered.

### Why is it not possible to change parameters?

- Has the installer password been entered correctly? Check whether you are in "Installer Level" (see section 10.5 "Entering the Installer Password" (Page 74)). If necessary, repeat the calculation and entry of the password.
- You are in the "100-Meters" (Measuring data) menu or the "300-Diagnose" (Diagnosis) menu. You can only read the data values shown here.

- Some parameters can only be changed in standby mode or in the QCG (see e.g. the "233.07 GnStrMod" parameter in section 19.2 "Adjustable System Parameters" (Page 139)). Stop the Sunny Island 5048 as described in section 9.2 "Stopping" (Page 62). Note that this causes a dropout in the stand-alone grid and the loads are no longer supplied.

### **Why does the Sunny Island 5048 connect to the running generator only for a short time?**

- The limits for the maximum permissible AC voltage or the minimum permissible frequency of the generator are too strict (parameter in the menu "233# Generator Control"). Change voltage and/or frequency limits according to the technical data of your generator.

### **Why is the stand-alone grid frequency not at 50 Hz?**

- The Sunny Boy inverter is controlled via the frequency (see section 17.3 "Frequency Shift Power Control (FSPC)" (Page 129)).
- The "AFRA" function of the Sunny Island 5048 is activated (see section 12.6 "Automatic Frequency Adjustment" (Page 91)).
- Fluctuations in power cause deviations in frequency.
- The generator runs in droop mode at an average of 50 Hz, but the Sunny Boys can be shut down by the frequency.

### **Why does the "VAC-Low" error (output voltage too low) also occur when the Sunny Island 5048 is started?**

- A permanent short-circuit exists in the stand-alone grid. Check the AC output connections of the stand-alone grid (see section 6.3 "AC Connection" (Page 36)).
- The loads connected to the stand-alone grid are too heavy. The power/electrical energy of the Sunny Island 5048 is not sufficient to supply the loads. Switch of some of the loads and restart the Sunny Island 5048.

### **What happens in case a battery cell can no longer be used?**

- Remove the unusable cell from your battery bank. Start the Sunny Island 5048 and change the battery voltage in the QCG under "New Battery".

### **What can I do when the QCG is not running?**

- Switch off the Sunny Island 5048 (see section 9.3 "Switching Off" (Page 63)) and restart it (see section 9.1 "Switching On/Starting" (Page 61)).

### **What happens in case "MMC operation failed" is displayed?**

- You tried to perform an action using the MMC/SD card, but this action failed (see section 10.9 "Display of Warnings and Failures" (Page 78)). Check the card (on your PC/Laptop) and use a new MMC/SD card, if required.

**Why does the Sunny Island 5048 remain switched on although the DC circuit breaker has been set to Off?**

- It is possible that the Sunny Island 5048 is supplied via the AC side. Switch off all AC loads and disconnect them from the Sunny Island 5048 (see section 9.4 "Disconnecting the Device from Voltage Sources" (Page 63)).

**Why is the battery discharging even though the generator is running?**

- The power produced by the generator does not reach the Sunny Island 5048. Check the voltage and frequency values. It is possible that the generator fuses have been triggered.

**Why is the deactivation defined by the SOC in case of a full or equalization charge and generator start in the second time zone?**

- Equalization charge has a higher priority than silent time.

**Why is the SOC not at 100 % even after full charging has been completed?**

- Define a longer period of time of absorption.

**How is it possible to ensure that the maximum battery charging current is correctly calculated after a reinstallation of the battery current sensor?**

- Re-calibrate the battery current sensor using the "225.04 BatCurAu-toCal" parameter with the setting "Start".

**What is required in case the Sunny Island 5048 is continuously switched off after Low Battery Mode (LBM) when restarting the device?**

- Start the generator manually, if required (e. g. Run 1h). Consider the time for warming up: 5 minutes without charging current in BatProtMode can cause the device to change to standby mode.

**How is it possible to change between wintertime and summertime operation e. g. in case of alpine huts?**

- Save two different parameter sets on the MMC/SD card and activate them via the "510.08 ParaLod" parameter (see section 11.3 "Loading and Saving Parameters" (Page 84)).

**What happens when inserting a non-FAT16 card?**

- The Sunny Island 5048 displays "Incomp".

**Why does the generator and/or the grid not reconnect although the (voltage or frequency) limit for disconnection has not been exceeded?**

- The Sunny Island 5048 connects with a so-called hysteresis, i. e. the connection value is slightly above the disconnection value. These limit values are preset at the factory.

**Why is it not possible to set any combinations of voltage and frequency limits?**



- The possible ranges for voltage and frequency of the Sunny Island 5048 allow the combination of special frequencies and voltages that result in transformer saturation and are therefore not permitted.

## 20.10 Procedure During Emergency Charge Mode

The Sunny Island 5048 cannot provide voltage with full amplitude in case of a deeply discharged battery. Synchronization with an existing grid or generator is no longer possible. Using the emergency charge mode (ECM), it is possible to charge the batteries in current-controlled mode.

In order to charge the battery in emergency charge mode, either bridge AC1 with AC2 (in case of a stationary generator) or connect a portable generator directly to AC1.



*The battery management is active and the currently set battery parameters and current charge phase are used. These values can be changed in "normal operation".*





*In emergency charge mode, the generator management and grid management are not active. Reverse power protection and relay protection are also not active.*



All loads must be disconnected in emergency charge mode.



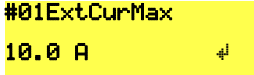
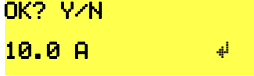
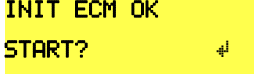

*In case that AC1 and AC2 have been bridged the generator should be connected and then manually started. Otherwise, it is possible that the magnetizing current trips the generator fuse. (This can also happen when connecting the relay without using a bridge.)*

Emergency charge mode is activated in the QCG. For a description how to access the QCG see section 8.2 "Starting the Quick Configuration Guide (QCG)" (Page 57). Follow the instruction up to point 5. The emergency charge mode is described below.

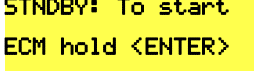
1. You are now in the Quick Configuration Guide (QCG). **01#StartMenu**  
You can select: **Emerg. Charge** 
  - **"Start System"**
  - **"New System"**
  - **"New Battery"**
  - **"Emerg Charge"** (if you intend to charge a deeply discharged battery using an external source see section 20.9 "Troubleshooting" (Page 166))
2. Select "Emerg. Start" and press <ENTER>. Confirm with **OK? Y/N**  
<ENTER> in the following view. **Emerg. Charge** 

- 3. Set the maximum external current, e. g. the generator current 
- 4. Confirm the value by pressing <ENTER>. 
- 5. Press the "arrow down" key, the following message is displayed: 
- 6. Confirm by pressing <ENTER>. 
- 7. Press <ENTER> again and start the emergency charge mode (ECM). 

It is possible to interrupt the emergency charge mode, e. g. in order to refill diesel.

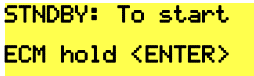
- 8. Press the <ENTER> key in order to stop the Sunny Island 5048. The following display appears. 
- 9. Press and hold the <ENTER> key, the remaining time is shown as bar on the display. 
- 10. The emergency charge mode has been interrupted and the following message is displayed: 

*In order to exit the emergency charge mode early, the Sunny Island 5048 must be restarted with the "510.01 InvRs" parameter.*



In emergency charge mode process values are shown in the display. Parameter values cannot be changed during the charging process. When restarting the device the settings saved before ECM are loaded.



*After emergency charge mode has been completed make sure to remove the bridge between AC1 and AC2!*



***Information to restart and wait for five minutes (see also section 9.5 "Restarting the System after Automatic Shutdown" (Page 64)).***



# 21 Optional Devices

## 21.1 Accessories (Optional)

The following accessories are available for the Sunny Island 5048:

- GenMan (Generator manager) SMA order number "SI-GenMan-...") Allows the Sunny Island 5048 to control generators requiring more than a simple start/stop signal for remote control (see section 14.1.2 "Generator Start Options" (Page 104)).
- Separate fuse for the battery (SMA-ordering number: SI-Battfuse-...") Allows line protection (with thermal fuses) or disconnection with line protection (with NH fuses ...-NH 01-...) of the Sunny Island 5048 from the connected battery (see chapter 6.2.2 "Cable Protection" (Page 35))
- Separate 48 V DC contactor (SMA order number: "SI-LS-..." (with 25/40/65/95 A)  
Allows load shedding on the AC or DC side (see section 6.4.4 "Multi-function Relays 1 and 2" (Page 47)).
- Separate current shunt for battery current measurement (SMA order number: "SI-SHUNT...-...")  
Allows battery current measurement on DC side (see section 6.4.2 "Battery Current Sensor" (Page 41)).

**SMA** Technologie AG also offers an extensive range of products allowing you to communicate with the Sunny Island 5048, for data acquisition and more. The following devices are available:

- Sunny WebBox
- Sunny Sensor Box

The software which you can use to make settings in and read/analyze data from your inverter can be downloaded for free from the website of **SMA** Technologie AG at [www.SMA.de](http://www.SMA.de) (see section 24 "Contact" (Page 181)).

## 21.2 SMA Products (Optional)

A stand-alone system using the Sunny Island 5048 as the grid controller can also be fed with electrical energy from feed-in devices which do not require fossil fuels. **SMA** Technologie AG offers the following products for decentralized energy supply of AC consumer devices (see illustration on page 13):

- Sunny Boy inverters (for feeding in from PV systems):  
SB 700 / SB 1100 / SB 1100LV / SB 1700 / SB 2500 / SB 2800i / SB 3000 / SB 3300 / SB 3800 / SMC 5000 / SMC 5000A / SMC 6000 / SMC 6000A / SMC 6000TL / SMC 7000TL / SMC 8000TL
- Windy Boy inverters (for feeding in from wind turbines or hydropower systems):  
WB 1100 / WB 1700 / WB 2500 / WB 2800i / WB 3000 / WB 3300 / WB 3800 / WB 6000
- all Hydro-Boy inverters (for feeding in from fuel cell systems)



*A current list of the devices functioning with the Sunny Island 5048 can be obtained from the Sunny Island Hotline (see section 24 "Contact" (Page 181)).*

## 22 Technical Data

<b>Output data</b>	
Nominal AC voltage ( $V_{AC, nom}$ ) (adjustable)	230 V (202 to 253 V)
Nominal frequency ( $f_{nom}$ )	45 to 65 Hz
Continuous AC output ( $P_{nom}$ ) at 25 °C	5000 W
Continuous AC output ( $P_{nom}$ ) at 45 °C	4000 W
AC output for 30 min at 25 °C	6500 W
AC output power for 5 min at 25 °C	7200 W
AC output power for 1 min at 25 °C	8400 W
Nominal AC current ( $I_{AC, nom}$ )	21 A
Max. current (peak value) for 100 ms	100 A (100 ms)
Harmonic distortion of output voltage ( $K_{VAC}$ )	< 3 %
Power Factor ( $\cos \varphi$ )	-1 to +1
<b>Input data</b>	
Input voltage ( $V_{AC, ext}$ ) (adjustable)	230 V (172.5 to 250 V)
Input frequency ( $f_{ext}$ ) (adjustable)	50 Hz (40 to 70 Hz)
Max. AC input current ( $I_{AC, ext}$ ) (adjustable)	56 A (2 to 56 A)
Max. input power ( $P_{AC, ext}$ )	12.8 kW
<b>Battery data</b>	
Battery voltage ( $V_{Bat, nom}$ ) (adjustable)	48 V (41 to 63 V)
Max. battery charging current ( $I_{Bat, max}$ )	120 A
Continuous charging current ( $I_{Bat, nom}$ )	100 A
Battery capacity	100 to 10 000 Ah
Charge control	IUoU procedure with automatic full and equalization charge
Battery type	VRLA/FLA/NiCd

Efficiency/power consumption																			
Max. efficiency	95 % (at 1000 W)																		
Efficiency of > 90%	5–120 % P <sub>nom</sub>																		
<p><b>Wirkungsgradmessung 230 V Gerät (5kW Last, 300A DC Shunt)</b></p> <table border="1"> <caption>Approximate data points from the efficiency graph</caption> <thead> <tr> <th>Ausgangsleistung P2 [W]</th> <th>Wirkungsgrad</th> </tr> </thead> <tbody> <tr><td>0</td><td>0.80</td></tr> <tr><td>500</td><td>0.94</td></tr> <tr><td>1000</td><td>0.95</td></tr> <tr><td>1500</td><td>0.945</td></tr> <tr><td>2000</td><td>0.94</td></tr> <tr><td>3000</td><td>0.93</td></tr> <tr><td>4000</td><td>0.92</td></tr> <tr><td>5000</td><td>0.91</td></tr> </tbody> </table>		Ausgangsleistung P2 [W]	Wirkungsgrad	0	0.80	500	0.94	1000	0.95	1500	0.945	2000	0.94	3000	0.93	4000	0.92	5000	0.91
Ausgangsleistung P2 [W]	Wirkungsgrad																		
0	0.80																		
500	0.94																		
1000	0.95																		
1500	0.945																		
2000	0.94																		
3000	0.93																		
4000	0.92																		
5000	0.91																		
Operating consumption with no load (in standby)	25 W (< 4 W)																		
Certification																			
	CE																		
Protection rating																			
According to DIN EN 60529	IP 40 (with plugged-in MMC/SD card), otherwise IP 30																		
Device protection																			
	short circuit, overload, overtemperature																		
Interfaces																			
	2 LEDs, 4 keys two-line display, 2 multi-function relays, RS485/RS232/CAN gal- vanically isolated (opt.), MMC/SD card																		



Digital input level (Dig-In)	high level as of 9 V (up to 63 V), low level 0–3 V
Load limits for multi-function relays 1 and 2	AC: 1 A at 250 V~ DC: see graphic
<p style="text-align: center;">Load Limit Curve</p>	
<b>Mechanical data</b>	
Width x height x depth	(467 x 612 x 235) mm
Weight	approx. 63 kg
<b>Ambient conditions</b>	
Ambient temperature	-25 °C to +50 °C
<b>Miscellaneous</b>	
Guarantee (EU)	2 years
<b>Accessories</b>	
Ext. battery temperature sensor	included
Generator manager (GenMan)	optional



# 23 CE Declaration of Conformity

## CE-Konformitätserklärung



für Insel-Wechselrichter

**Produkt:** Sunny Island  
**Typ:** SI 5048

Hiermit erklären wir, dass die bezeichneten Geräte auf Grund ihrer Konzeption und Bauart sowie in der von uns in Verkehr gebrachten Ausführung den Richtlinien der Europäischen Union, insbesondere der EMV-Richtlinie gemäß 89/336/EWG und der Niederspannungsrichtlinie gemäß 73/23/EWG, entsprechen.

Im Einzelnen erfüllen die oben aufgeführten Geräte die folgenden Normen:

DIN EN 50178 (04.98) (VDE 0160)  
DIN EN 61000-3-2: 2001-12  
DIN EN 61000-6-1: 2002-08  
DIN EN 61000-6-2: 2002-08  
DIN EN 61000-6-3: 2002-08  
DIN EN 61000-6-4: 2002-08

**Die oben aufgeführten Geräte werden daher mit einem CE-Zeichen ausgestattet.**

Hinweis:

Diese Konformitätserklärung verliert ihre Gültigkeit, wenn das Produkt ohne ausdrückliche Zustimmung von SMA

- umgebaut, ergänzt oder in sonstiger Weise verändert wird,
- und/oder Bauteile, die nicht zum SMA Zubehör gehören, in das Produkt eingebaut werden,
- sowie bei unsachgemäßem Anschluss oder nicht bestimmungsgemäßer Verwendung

Niestetal, den 16.10.2006

**SMA Technologie AG**

i.V. Andreas Berger  
(Abteilungsleiter Entwicklung)

**SMA Technologie AG**

Hannoversche Straße 1-5  
34266 Niestetal  
Tel. +49 561 9522 - 0  
Fax +49 561 9522 - 100  
www.SMA.de  
info@SMA.de



SIS048CE-118D4006



## 24 Contact

If you have any questions or queries, please contact us. A team of qualified engineers and technicians is at your disposal. Help us to help you by having the following information ready when you call us:

- Type of inverter (Sunny Island 5048, see type plate)
- Type of voltage/frequency
- Serial number (see type plate or parameter "312.03 SN")
- Firmware version (see parameter "312.02 FwVer")
- Error message shown on the display
- Battery type
- Nominal battery capacity
- Nominal battery voltage
- Communication products used
- Type and size of additional energy sources (generators, PV systems or PV inverters)
- If a generator exists:
  - Generator type
  - Generator capacity
  - Max. generator current
  - Generator interface

*Always use the MMC/SD card for saving data and events. In case of a failure **SMA** Technologie AG can thus quickly help you. In order to ensure that the current failure and event list is saved on the MMC/SD card, write all data with the "550.01 CardFunc" and the selection "ForceWrite" to the MMC/SD card.*



SMA Technologie AG

Hannoversche Strasse 1 - 5

34266 Niestetal

Germany

Tel. (+49) 561 95 22 - 399

Fax (+49) 561 95 22 - 4697

SunnyIsland.hotline@SMA.de

[www.SMA.de](http://www.SMA.de)



## 25 Glossary

### Absorption Phase

Constant V phase: a charging phase using constant charging voltage. The charging current constantly decreases during this phase.

### AC

Abbreviation for "Alternating Current".

### AC Coupling

The connection of various loads, generators and storage devices on the AC side.

### AGM Battery

Absorbent Glass Mat separator battery. This is a battery where the electrolyte (a mixture of water and sulfuric acid) is bound to a glass fiber mat. This is a type of so-called closed lead acid battery. A gas mixture (hydrogen and oxygen) is always generated when lead acid batteries are charged, and in normal operation this is internally recombined to form water. This removes the need for regularly refilling the battery cells with water, which is why these batteries are often described as "low maintenance" or even "maintenance free". AGM batteries are available from many different manufacturers for a wide range of applications. They usually have very good high current properties but are not very charge-cycle resistant.

### Ah

Abbreviation for "ampere hours": unit of electrical charge; one ampere hour is the charge provided by a constant current of 1 A over a period of one hour - when two separate charges are connected.

### Anti-Islanding

Anti-Islanding is a procedure for preventing unintended islanding on the generator and/or external grid connection point. It is required in order to ensure that, in case of a public grid dropout or generator failure, the Sunny Island reliably prevents possible reverse voltages in these power supply units.

### Automatic Disconnection Device

The "automatic disconnection device between a grid parallel power-generating system and the public low voltage grid" (DIN VDE 0126-1-1) is an equivalent replacement for a normal public disconnection device with isolation function which is accessible to the distribution grid operator at any time. This is a mandatory safety device which prevents energy from a solar power system being fed into an external power grid when the external power generator is not functioning. In the Sunny Boy / Sunny Mini Central, this function is performed by the "SMA grid guard Version 2". In case of the Sunny Island 5048 it is integrated into the Automatic Switch Box.

## **Automatic Switch Box**

Switching unit switching the Sunny Backup System between grid and off-grid operation. In grid operation, a PV plant in the Sunny Backup System is operated via an automatic disconnection device at its own feed-in counter. In case the grid drops out it is switched to the stand-alone grid separated from the public grid. The box can optionally integrate a diesel generator into the Sunny Backup System.

## **Backup System**

So-called backup systems are power supply systems which provide an extra level of security for standard power supply systems. The public grid is usually the standard power supply system, which is backed up by an additional stand-alone grid system in case of a power outage. In addition to the backup systems, diesel generators in PV battery systems are also described as backup generators. Here they perform the same task as a backup system for the public grid.

## **Battery**

A battery is an electrochemical storage device which can release previously stored chemical energy as electrical energy. A distinction is made between non-rechargeable primary elements (often used in (e.g.) consumer markets) and rechargeable secondary elements (accumulators). In so-called stand-alone grid systems, the batteries used as rechargeable secondary elements are almost exclusively lead acid batteries and, very rarely, nickel/cadmium batteries.

## **Battery Management**

The battery management is responsible for optimal battery charging and reliable protection against deep discharge. This is the only way of ensuring that the battery service life reflects the manufacturer's specifications.

## **Battery System**

Series connection and possibly also parallel connection of several identical batteries. Battery banks of 12 V, 24 V, 48 V and 60 V are typical.

## **Battery Bank**

See Battery System.

## **Battery Charging Mode**

A battery inverter operating mode, in which the inverter takes energy from the AC grid to recharge the battery in a controlled way. In this operating mode, the battery inverter is primarily responsible for correctly charging the battery, and acts as an independent battery charger.

## **Battery Power Converter**

A bidirectional power converter which can regulate voltage and frequency in a stand-alone grid and is also responsible for correct battery charging.

## **Battery Inverter**

See Battery Power Converter.



## **Boost Charge**

Quick charge: allows the battery to be charged to a level of approx. 85 – 90 % as quickly and efficiently as possible.

## **Bulk Phase**

I-Phase: the charging phase in which charging can be performed using the maximum charging current.

## **Capacity**

Describes the storage capability of a cell or battery, specified in Ah (ampere hours). The capacity of a battery is heavily dependent on the charging cycle, the amount of current drawn and the temperature.

## **Central Inverter**

An inverter concept, in which all PV modules are connected to each other (in series and/or parallel) and which uses a single inverter for feeding energy into the external grid. The lower cost of the inverter is usually offset by the much higher installation outlay required and possible yield losses due to variations in shadowing on individual solar modules.

## **Charge Level**

Describes the present amount of charge which can be drawn from the battery, in percent of the nominal capacity (100 % = battery full, 0 % = battery empty).

## **Charge Mode**

See Battery Charging Mode.

## **Charging Throughput**

See Nominal Charging Throughput

## **Cluster**

Several Sunny Island or Sunny Backup inverters which are connected in parallel on the DC side and connected to a common battery system. These inverters can also be connected in parallel on the AC output side (single-phase system) or for a multi-phase system. The devices within a cluster must be connected via a communication cable and configured in a way that one device (-> master) leads the cluster and all other devices (-> slaves) communicate with the leading device.

## **C-Rate**

The nominal capacity specification is always provided along with the discharge time on which the capacity is based. The nominal capacity is the "product" of the constant charging current  $I_N$  and the "discharge time"  $t_N$ , which passes between commencement of discharging the fully charged battery and when the final discharge voltage  $V_S$  is reached. For permanent on-site batteries, the C10 capacity is usually specified, i. e. a battery with  $C10 = 200$  Ah can be discharged for 10 hours at a nominal current of  $0.1 \times C10 = 110 = 20$  A.

## **DC**

Abbreviation for "Direct Current".

## **Derating**

A controlled reduction in performance, usually dependent on component temperatures. Compared with the (also common) practice of completely shutting down the device, the effect on the external grid is smaller with derating.

## **DSP**

Abbreviation for Digital Signal Processor. A DSP is a microprocessor chip especially developed for digital signal processing and control.

## **Electrolyte**

Allows the conduction of ions within a battery. In a lead acid battery, the electrolyte is diluted sulfuric acid and is also a reactant in the electrochemical reaction. Nickel/cadmium batteries use an alkaline electrolyte (potassium hydroxide).

## **EPROM**

See Flash EEPROM.

## **Equalize Charge**

Equalization charge: allows different series-connected battery cells to be charged to a unified charge level of 95 - 100 %. Without regular equalization charging, the charge states of the individual cells slowly drift apart, which can lead to premature battery bank failure.

## **Firmware**

Firmware is software which is embedded in a chip in various electronic devices, such as hard disk recorders, DVD burners and players, newer television sets, household appliances and computers - in contrast to software, which is stored on hard drives, CD-ROMs or other media. These days, firmware is usually stored in a flash memory or an EEPROM.

## **FLA**

Flooded lead acid battery: a lead acid battery with liquid electrolyte, also often described as a closed lead acid battery.

## **Flash EEPROM**

The abbreviation EEPROM stands for Electrically Erasable Programmable Read-Only Memory. Flash memories are digital storage devices (chips). The exact designation is "flash EEPROM". In contrast to "normal" EEPROM memories, in flash EEPROM it is not possible to delete individual bytes (the smallest addressable memory units).

EEPROM is a non-volatile, electronic memory component used (for example) in computer technology, and mainly in embedded systems.

Flash EEPROMs are used where information must be stored in a non-volatile manner in the smallest amount of space, e.g. for storing the firmware.

## Float Charge

Allows the battery to be slowly charged to a charge level of 100 % without the negative effects of overcharging. Complete charging to 100% using float charge takes several days. For this reason, float charging is more important for grid backup systems and less important for stand-alone grids.

## Full Charge

Recharging of the battery to a level of approx. 95 % on a regular basis (at least once a month). This efficiently avoids premature battery aging caused by inadequate charging.

## Gel Battery

A type of battery in which the electrolyte (a mixture of water and sulfuric acid) is bound into a gel. This is a type of so-called closed lead acid battery. A gas mixture (hydrogen and oxygen) is always generated when lead acid batteries are charged, and in normal operation this is internally recombined to form water. This removes the need for regularly refilling the battery cells with water, which is why these batteries are often described as "low maintenance" or even "maintenance free" (see also AGM Battery). Gel batteries are available from many different manufacturers for a wide range of applications. There are gel batteries for high-current applications but also for cycle operation with very high cycle resistance.

## Generator

An electrical generator is an electrical machine which converts kinetic or mechanical energy into electrical energy. Here, not only the electrical generator itself, but also the combustion unit (diesel, petrol, or gas motor) necessary for the power unit is combined together with the electrical generator and simplified under the term "generator". This is also described colloquially as a power generator.

## Grid-Coupled System

PV system which is connected to the power supply grid of an external energy supplier.

## Inverter

A device for converting the direct current (DC) from the PV generator into alternating current (AC), which is necessary for connection of most normal household devices and especially for feeding solar energy into an existing supply grid. Inverters for PV systems usually include at least one MPP tracker, store operating data, and monitor the grid connection of the PV system (see also MSD).

## Invert Mode

See Inverter Operation.

## Inverter Operation

Operating mode of a battery inverter where it supplies the stand-alone grid from the battery energy. In this operating mode, the battery inverter is especially responsible for the control of frequency and voltage in the stand-alone grid.

## Islanding

Islanding is an undesired situation on the generator and/or external grid connection point. In these situations the danger exists that the Sunny Island supplies reverse voltages in these power supply units in case of a public grid dropout or generator failure.

## Main Cluster

Leading cluster in a multicluster system. The main cluster is responsible for e. g. the voltage and frequency control, grid monitoring, generator control, load management as well as the control of the Automatic Switch Box in a backup system.

## Maintenance Charge

see Float Charge

## Master

Configuration setting that defines a Sunny Island of backup inverter to be the master within a cluster. This defines that central control and monitoring tasks that need to be done only by one device (such as frequency control, battery management, generator control, control of the Automatic Switch Box in a Sunny Backup system) are done by this device. All other inverters of the cluster must be configured in a way that these tasks are done by the master and that these inverters are controlled by the master (-> Slave). The master is additionally the device that is used for the configuration and operation and the central data acquisition.

## Maximum Power Point "MPP"

The working point (current/voltage characteristic curve) of a PV generator where the maximum power can be drawn. The actual MPP changes constantly depending (e.g.) on the level of solar irradiation and the ambient temperature.

## Multicluster System

Parallel connection of several clusters in a stand-alone grid or backup system on the AC output side. The master devices of the single clusters must be connected via a communication cable and configured in a way that the cluster is responsible for the management of the entire system (see Main Cluster) and that the master devices of all other clusters (see Sub-Cluster) communicate with the managing cluster.

## Multi-String Inverter

An inverter which to a great extent combines the advantages of several string inverters (separate MPP tracking of individual strings) and a central inverter (low performance-specific costs).

## MPP Tracker

Regulation of the power drawn so that a PV generator is operated for as long as possible at the MPP. This working point varies with the solar irradiation and temperature conditions of the modules. MPP tracking optimizes the extraction of electrical power and is a feature of inverters and charge controllers.

## **MSD**

See Automatic Disconnection Device.

## **Nominal Charging Throughput**

The charging throughput is the cumulative total discharge current over time, measured in ampere hours (Ah). These meters are not automatically reset after charging. The nominal charging throughput is the charging throughput with regard to the nominal capacity of the batteries.

## **NiCd**

Nickel/cadmium battery, contains nickel, cadmium, and potassium hydroxide as the electrolyte. They require a significantly higher charging voltage, have a lower level of efficiency and are significantly more expensive than lead acid batteries. However, their robustness, cycle resistance and low-temperature capabilities allow them to be used in certain special applications.

## **NLM**

Abbreviation for "Netzleitungsmodem" (Powerline modem): communication between SMA inverters and monitoring devices is possible via a cable, a radio link, or a Powerline modem. Powerline modems use a carrier frequency of approx. 132 kHz modulated onto the AC cables, and data is transferred using FSK (Frequency Shift Keying) of this carrier signal. Details on the Powerline modem can be found (e.g.) in the technical description of the SMA-NLM.

## **Overload Capability**

The overload capability of an inverter describes its ability to supply short-term (seconds or minutes) excessive loads, that can be significantly higher than the nominal capacity of battery inverters. The overload capability is important to allow startup of electrical machines which have a nominal power output close to the nominal power output of the stand-alone grid inverter, since these machines typically require six times the nominal current when starting.

## **Parallel Connection**

Parallel connection of batteries (all positive poles together and all negative poles together) increases the capacity of the battery bank while keeping the voltage constant. For example, two 24V/100Ah batteries connected in parallel still have a voltage of 24 V, but have a capacity of  $100 \text{ Ah} + 100 \text{ Ah} = 200 \text{ Ah}$ .

## **Photovoltaics**

See "PV"

## **Piggy-Back (Board)**

A printed circuit board which is plugged into another board to increase performance or expand capabilities. A piggy-back board can also replace an individual chip. In this case, the chip is removed and the board is plugged into the empty socket.

## **PLC**

Abbreviation for "power line communication": describes the process of data transfer over the grid connection. The PLC power module is used to amplify the signal and is connected in Multi-String and Sunny Mini Central inverters.

## **PV**

Photovoltaics (PV) is the conversion of solar irradiation into electrical energy using special semiconductors, so-called solar cells.

## **PV System**

Describes a solar power system for generating electrical power. This includes the complete collection of components required for the acquisition and utilization of solar energy. As well as the PV generator, this also includes the Sunny Boy or Sunny Mini Central inverter, for example, in the case of grid-connected systems.

## **PV Generator**

Technical device for the conversion of solar energy into electrical energy. This term encompasses all the electrically connected (in series and in parallel) solar modules in a PV system.

## **PV Module**

See "Solar Module".

## **Rapid Charge**

see Boost Charge

## **Self Discharge**

Capacity loss of a battery cell while it is stored or not used. A higher ambient temperature has a strong influence on self discharge.

## **Series Connection**

In this case the positive pole of each battery is connected to the negative pole of the next battery. There is only one circuit where current can flow. Series connection increases the voltage of the entire battery bank. If two 24 V batteries with a capacity of 100 Ah each are connected in series, the total voltage is  $24\text{ V} + 24\text{ V} = 48\text{ V}$ , while the total capacity remains at 100 Ah.

## **Slave**

Configuration setting that defines a slave role for the respective Sunny Island or Backup inverter within a cluster. This relieves the device from control or monitoring tasks that must or should only be done by one single device (-> Master) within the cluster. Slave devices use the configuration settings, the current firmware and start and stop commands from the respective master and transmit event messages and warnings and failure messages to the master.

## **SOC**

State of Charge: the charge level of the battery, see Charge Level. If (e.g.) 25 Ah is taken from a 100-Ah battery, the charge level (SOC) is then 75 %.

## **SOH**

State of health: describes the relationship between the present capacity and the battery's nominal value, given as a percentage.

## **Solar Energy**

"Sun energy", this means energy from sunlight or other solar irradiation (heat and/or UV radiation).

## **Solar Module**

Electrical connection of several solar cells encapsulated in a housing to protect the sensitive cells from mechanical stress and environmental influences.

## **Solar Cell**

An electronic component which generates electrical energy when irradiated with sunlight. Since the voltage produced by a single solar cell is very small (approx. 0.5 V), several solar cells are combined to form a solar module. The most common semiconductor material presently used for solar cells is silicon, which is manufactured in different forms (monocrystalline, polycrystalline, amorphous). In addition to vastly different mechanical variations, which are usually designed to increase the level of efficiency, completely new materials are currently being tested (cadmium telluride, cadmium indium sulphide, titanium dioxide and many others).

## **Stand-Alone Grid System**

An energy generation system which is completely independent of any external power sources.

## **String**

Describes a group of solar modules electrically connected in series. A PV system usually consists of a number of strings, which avoids excessive yield losses caused by variations in shadowing on different modules.

## **String Inverter**

An inverter concept which avoids the disadvantages of the central inverter concept. The PV generator is split into individual strings, each of which is connected to the external grid by means of its own string inverter. This largely simplifies installation and reduces the yield losses which can be caused by manufacturing deviations or variations in shadowing on the solar modules.

## **Sub-Cluster**

Cluster in a multicluster system which is subordinate to the main cluster and is therefore not responsible for the management of the entire system.

**VRLA**

Valve regulated lead acid battery: lead acid battery with semi-solid electrolyte or closed lead acid battery. Examples of this type of battery are gel batteries and AGM batteries (Absorbent Glass Mat).





The information contained in this document is the property of SMA Technologie AG. Publishing its content, either partially or in full, requires the written permission of SMA Technologie AG. Any internal company copying of the document for the purposes of evaluating the product or its correct implementation is allowed and does not require permission.

## Exclusion of liability

The general terms and conditions of delivery of SMA Technologie AG shall apply.

The content of these documents is continually checked and amended, where necessary. However, discrepancies cannot be excluded. No guarantee is made for the completeness of these documents. The latest version is available on the Internet at [www.SMA.de](http://www.SMA.de) or from the usual sales channels.

Guarantee or liability claims for damages of any kind are excluded if they are caused by one or more of the following:

- Improper or inappropriate use of the product
- Operating the product in an unintended environment
- Operating the product whilst ignoring relevant, statutory safety regulations in the deployment location
- Ignoring safety warnings and instructions contained in all documents relevant to the product
- Operating the product under incorrect safety or protection conditions
- Altering the product or supplied software without authority
- The product malfunctions due to operating attached or neighboring devices beyond statutory limit values
- In case of unforeseen calamity or force majeure

## Software licensing

The use of supplied software produced by SMA Technologie AG is subject to the following conditions:

This software may be copied for internal company purposes and may be installed on any number of computers. Supplied source codes may be changed or adapted for internal company purposes on your own responsibility. Drivers may also be transferred to other operating systems. Source codes may only be published with the written permission of SMA Technologie AG. Sub-licensing of software is not permissible.

Limitation of liability: SMA Technologie AG rejects any liability for direct or indirect damages arising from the use of software developed by SMA Technologie AG. This also applies to the provision or non-provision of support activities.

Supplied software not developed by SMA Technologie AG is subject to the respective licensing and liability agreements of the manufacturer.

## Trademarks

All trademarks are recognized even if these are not marked separately. Missing designations do not mean that a product or brand is not a registered trademark.

SMA Technologie AG

Hannoversche Straße 1-5

34266 Niestetal

Germany

Tel. +49 561 9522-0

Fax +49 561 9522-100

[www.SMA.de](http://www.SMA.de)

E-mail: [info@SMA.de](mailto:info@SMA.de)

© 2004 – 2007 SMA Technologie AG. All rights reserved.



**Sales**  
**Solar Technology**

[www.SMA.de](http://www.SMA.de)

**SMA Technologie AG**  
**Hannoversche Strasse 1-5**  
**34266 Niestetal, Germany**  
**Tel.: +49 561 9522 4000**  
**Fax: +49 561 9522 4040**  
**E-mail: [sales@SMA.de](mailto:sales@SMA.de)**  
**Freecall: +800 SUNNYBOY**  
**Freecall: +800 78669269**



Innovation in Systems Technology  
for the Success of Photovoltaics

