



Sunny Beam Wireless PV System Monitor



User Manual

U.S. Version 1.1

SBEAM-11:SE0706

Copyright © 2005 SMA America, Inc. All rights reserved.

All rights reserved. No part of this document may be reproduced, stored in a retrieval system, or transmitted, in any form or by any means, electronic, mechanical, photographic, magnetic or otherwise, without the prior written permission of SMA America, Inc.

SMA America makes no representations, express or implied, with respect to this documentation or any of the equipment and/or software it may describe, including (with no limitation) any implied warranties of utility, merchantability, or fitness for any particular purpose. All such warranties are expressly disclaimed. Neither SMA America nor its distributors or dealers shall be liable for any indirect, incidental, or consequential damages under any circumstances.

(The exclusion of implied warranties may not apply in all cases under some statutes, and thus the above exclusion may not apply.)

Specifications are subject to change without notice. Every attempt has been made to make this document complete, accurate and up-to-date. Readers are cautioned, however, that SMA America reserves the right to make changes without notice and shall not be responsible for any damages, including indirect, incidental or consequential damages, caused by reliance on the material presented, including, but not limited to, omissions, typographical errors, arithmetical errors or listing errors in the content material.

Revision History

Document Number	Rev. No.	Date	By	Description
n/a	0.1	May, 2005	JP	Alpha draft
SBEAM-11:SE3605	1.0	Sept, 2005	JP	First Release
SBEAM-11:SE0706	1.1	Feb, 2006	JP	Update

SMA America, Incorporated
12438 Loma Rica Drive
Grass Valley, California 95945
Tel 530.273.4895
Fax 530.274.7271
www.sma-america.com

IMPORTANT SAFETY INSTRUCTIONS

SAVE THESE INSTRUCTIONS

This manual contains important instructions for the Sunny Beam that must be followed during the installation, operating and maintenance of the Sunny Beam.

The Sunny Beam is designed and tested according to international safety requirements, but as with all electrical and electronic equipment, certain precautions must be observed when installing and/or operating the Sunny Beam. To reduce the risk of personal injury and to ensure the safe installation and operation of the Sunny Beam, you must carefully read and follow all instructions and warnings in this *Installation Guide*.

Safety and Hazard Symbols



This symbol is used to call attention to important information that you must have when installing and/or operating the Sunny Beam. Failure to read and follow instructions marked with this symbol could result in serious injury and/or damage to the equipment.



This symbol appears beside instructions and warnings that deal with dangerous voltages that can injure people who come in contact with them.

Warnings



WARNING: A Warning describes a hazard to equipment or personnel. It calls attention to a procedure or practice, which, if not correctly performed or adhered to, could result in damage to or destruction of part or all of the SMA equipment and/or other equipment connected to the SMA equipment or personal injury.

Warnings may also be accompanied by one or more of the safety and hazard symbols described above to indicate the type of hazard described therein.

Other Symbols

In addition to the safety and hazard symbols described previously, the following symbol is also used in this *Installation Manual*:



This symbol accompanies notes that call attention to supplementary information that you should know to ensure optimal operation of the system.

Warranty

All Sunny Beam units sold in the USA have a one-year warranty, as indicated on the warranty card included in the shipping container. For warranty coverage, or if you have questions about the Sunny Beam warranty, contact SMA America at the address, telephone number, or Web site listed on page iii (to send E-mail, see the Contact section of the SMA America Web site: www.sma-america.com).



WARNING: All electrical installation must be done in accordance with the National Electrical Code ANSI/NFPA 70, local building codes and the requirements of the authority having jurisdiction.



WARNING: Other than the AA batteries, the Sunny Beam contains no user-serviceable parts. Always contact an SMA authorized Service Center for repairs and maintenance other than those detailed in this installation manual.



WARNING: Before installing or using the Sunny Beam, read all of the instructions and warnings in this Installation Manual.



WARNING: Only the antennas and coax cables supplied with the Sunny Beam may be used. Any modification to the antennas and/or coax cables will void the warranty.



WARNING: Changes or modifications not expressly approved by the party responsible for compliance could void the user's authority to operate this equipment.



WARNING: The Sunny Beam uses type RAM rechargeable alkaline batteries (Accucell 1800). Replace only with the same size and type of batteries or compatible.



WARNING: The Sunny Beam is designed for indoor use only.



WARNING: Remove the batteries if the Sunny Beam will not be operated for an extended period of time.



NOTE: The Sunny Beam relies upon clear radio reception to transfer data. The radio reception is subject to the influences of the unit's surroundings such as, other wireless devices, terrain and the construction materials of the building in which the device is used. For best results, try to locate the Sunny Beam where it will have a relatively clear path to the inverter.



NOTE: FCC NOTICE: To comply with FCC Part 15 rules, the system must be professionally installed to ensure compliance with the Part 15 certification. It is the responsibility of the operator and professional installer to ensure the only certified systems are deployed. The use of the system in any other combination (such as co-located antennas transmitting the same information) is expressly forbidden.



NOTE: FCC NOTICE: The FCC label shown in the figure below (left) must be affixed the the outside of the inverter cabinet. Each inverter that has a radio piggy back (right) installed must have this label. Place the label on the side of the inverter near the ratings label.



Introduction1
 System Requirements1
 Compatibility2
Unpacking2
Installation and Setup3
 Installing the Radio Piggy-Back3
 Mounting the Antenna5
Commissioning9
 Setup11
Operation14
 Power Supply14
 The Home Screen14
 Home Screen Display Options17
 Setup Options23
 Setup Menu27
 Using the USB Port33
 Sunny Data Control33
Troubleshooting41
 General Performance41
 Inverter Detection44
Specifications45

Introduction

The Sunny Beam allows wireless real-time data monitoring and storage for up to four SMA Sunny Boy inverters.

Sunny Beam features include:

- Large, easy to read LCD
- Real-time display of AC power output
- Daily and total energy yield displays
- Daily energy yields for the current month or last 31 days
- Built in solar cell to supplement internal batteries
- USB port for data collection on a PC with Sunny Data Control and recharging internal batteries

System Requirements

The Sunny Beam is a wireless device, therefore it requires that a Radio Piggy-Back board and antenna be installed on each inverter to be monitored.

The inverters must also be within radio range of the desired location of the Sunny Beam. Typical ranges for the Sunny Beam are 100 ft. indoors and 500 ft. outdoors. Because radio transmissions are effected a great deal by terrain, obstacles and other wireless devices, the actual usable distance will vary from system to system.

For example, the operating range could easily exceed 500 ft. outdoors given the right conditions such as line of sight between the Sunny Beam and inverter. However, the range could also be less if there is a structure between the two. The same is true for indoor installations. Keep this in mind when selecting a location for the Sunny Beam.

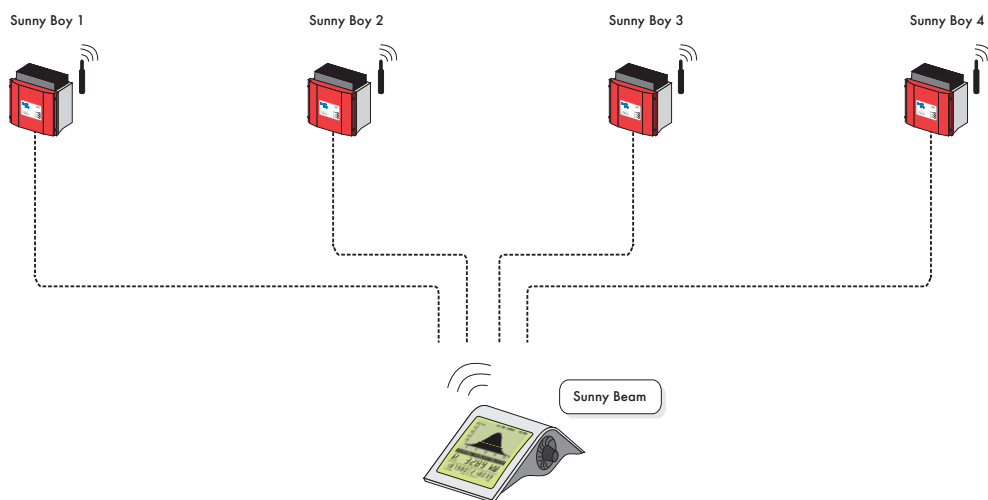

Figure 1-1 Sunny Beam Supports up to Four Sunny Boy Inverters

Compatibility

The following SMA inverters are compatible for use with the Sunny Beam:

- SB700U
- SB1100U
- SB1800U
- SB2500U
- SB3800U
- SB6000U

Unpacking

When unpacking the Sunny Beam, make sure that all of the components are present. Save the shipping container in the event that it ever becomes necessary to return your Sunny Beam to SMA America.



WARNING: The installation of the Sunny Beam requires access to the inside of the inverter to be monitored. Lethal voltages are present inside the inverters when they are operating and installation of the communication card should only be performed by qualified personnel.

The Sunny Beam shipping container should contain:

- The Sunny Beam with attached external antenna
- Radio Piggy-Back Board*
- Antenna for the inverter*
- 2 AA rechargeable alkaline batteries (AccuCell AC 1800)
- Wall mount bracket
- USB Cable

* The number of these items that are included will vary depending on the number of inverters to be monitored. The Sunny Beam may be purchased with up to 4 antenna kits. Please refer to the SMA America price list for kit part numbers.

Optional Accessories:

- USB power supply (for recharging internal batteries)
- External antenna mounting kit

Installation and Setup



WARNING: The installation of the Sunny Beam requires access to the inside of the inverter(s) to be monitored. Lethal voltages are present inside the inverters when they are operating and the installation of the communication card should only be performed by qualified personnel.



WARNING: Refer to the Installation Guide for the specific inverter for instructions on powering down and opening the inverter. This activity should only be performed by qualified personnel.



NOTE: Because the Sunny Beam's first task upon start-up will be to detect the inverters, it is important that the Piggy-Back board(s) be installed before powering up the Sunny Beam.

Installing the Radio Piggy-Back

After the inverter(s) have been powered down and all residual voltages discharged, the cover(s) should be removed. (Refer to the Installation Guide for the inverter.)

Groups

The Radio Piggy-Back is capable of operating in any of 16 different groups. The Sunny Beam comes from the factory preset for group number 1. This should work for most typical installations. Additional group settings are only required when multiple Sunny Beams will be used in the same system. The group function is used to determine which inverters each of the Sunny Beams would communicate with. For example, if there were two Sunny Beams, Sunny Beam A would communicate with the first 4 inverters on group 1 and Sunny Beam B would communicate with the other 4 inverters on group 2. The groups are selected by using the DIP switch on the Piggy-Back board. Verify that the switch is set for group number 1. Only the number 4 switch should be in the ON position. Refer to the illustration below.

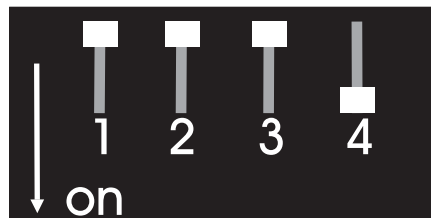

Figure 1-2 DIP Switch in Group 1 Position

Mounting the Radio Piggy-Back Board

After verifying the group setting, the Radio Piggy-Back may be mounted by gently pressing it onto the pins as shown in the illustration below.

 **NOTE:** Be sure to support the inverter circuit board from underneath when mounting the Piggy-Back. Excessive flexing of the circuit board may damage it.

Press the Piggy-Back in place until it is fully seated against the connectors on the circuit board.

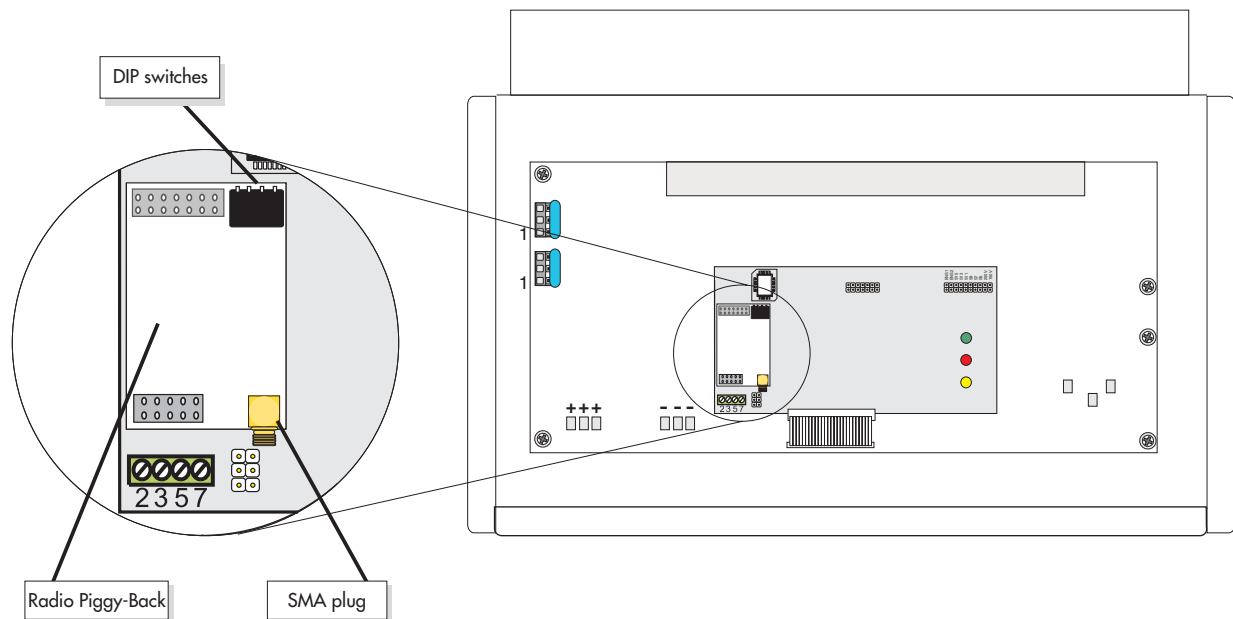

Figure 1-3 Installing the Radio Piggy-Back Board

Installation of the Radio Piggy-Back Board in SWR Type Inverters

If the Radio Piggy-Back boards are to be installed in an SWR type inverter, (this can be verified by checking the ratings label on the side of the inverter, e.g. SWR2500U/SWR1800U) an additional step must be taken. The SWR type inverters require the cutting of two resistors located on the circuit board where the Piggy-Back board will mount. See the following illustration. (This is not required for other SMA inverters.)

To cut these resistors:

- Use a small pair of wire cutters
- Cut the lower lead close to the circuit board
- Lift the resistor just enough to prevent connection
- Repeat for the second resistor

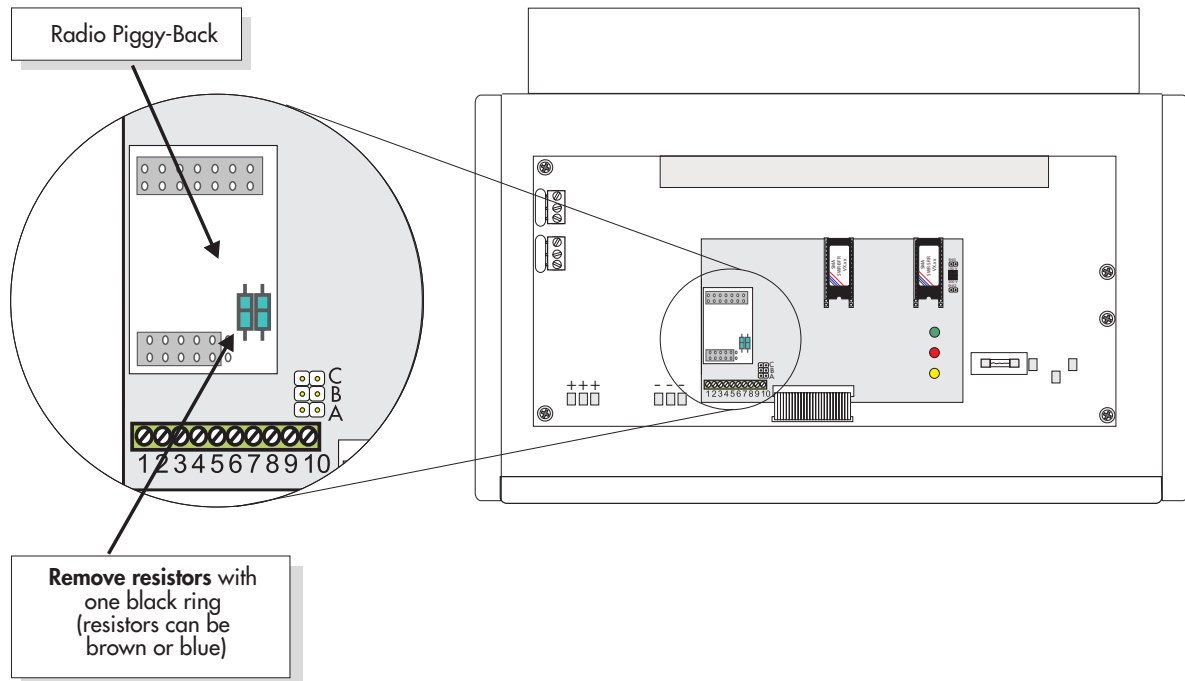

Figure 1-4 Resistor Location in SWR Type Inverters

Mounting the Antenna

The antenna provided for use on the inverter comes with a PG type connector for mounting to the underside of the inverter. The antenna will typically mount in the conduit hole provided for communications cables.

The PG connector is a PG13.5 type. A PG16 type adapter has also been provided. Inspect the communications conduit opening and determine if the opening will allow the PG16 adapter to fit properly. Install the antenna by following the steps and referring to the following illustration.

- Slide the seal-ring onto the antenna from the top, sliding it down the antenna to the base until it is flush with the bottom of the antenna. Make sure the narrow end of the seal-ring faces the base of the antenna.
- Slide the pressure screw over the coax and over the seal ring until the small bumps on the seal ring snap into the notches on the pressure screw.
- Slide the threaded sleeve over the top and down the antenna and thread it onto the pressure screw. Tighten the threaded sleeve until snug. Do not over tighten.
- If required, slide the PG16 adapter over the coax and thread it onto the pressure screw. Tighten the adapter until snug. Do not over tighten.
- Route the coax through the opening on the underside of the inverter until the pressure screw sits flush against the inverter

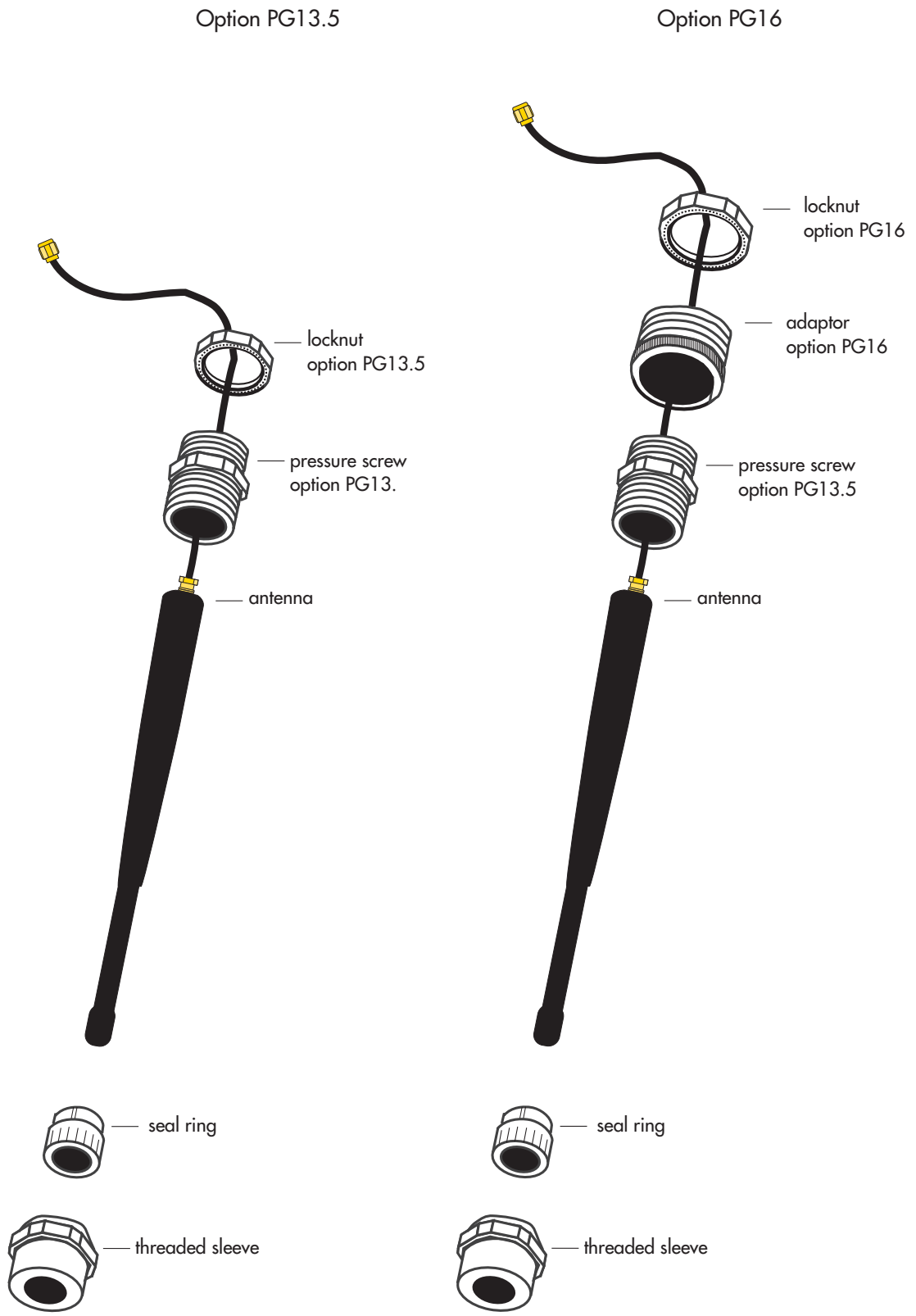

Figure 1-5 Antenna Assembly Options



NOTE: To operate effectively, the PG connector for the antenna must be grounded. It is important that the metal of the PG connector make good contact with the metal case of the inverter. Make sure that the teeth of the locknut face the metal and that the locknut is tightened sufficiently to allow good metal to metal contact.

- Thread the locknut onto the pressure screw and tighten.
- Once the antenna is in place, thread the coax connector onto the Radio Piggy-Back board. Tighten until snug - do not over tighten.
- Check the DIP switch to make sure that it was not changed accidentally during installation.
- Verify that the coax is routed through the inverter safely.
- Replace the inverter cover.

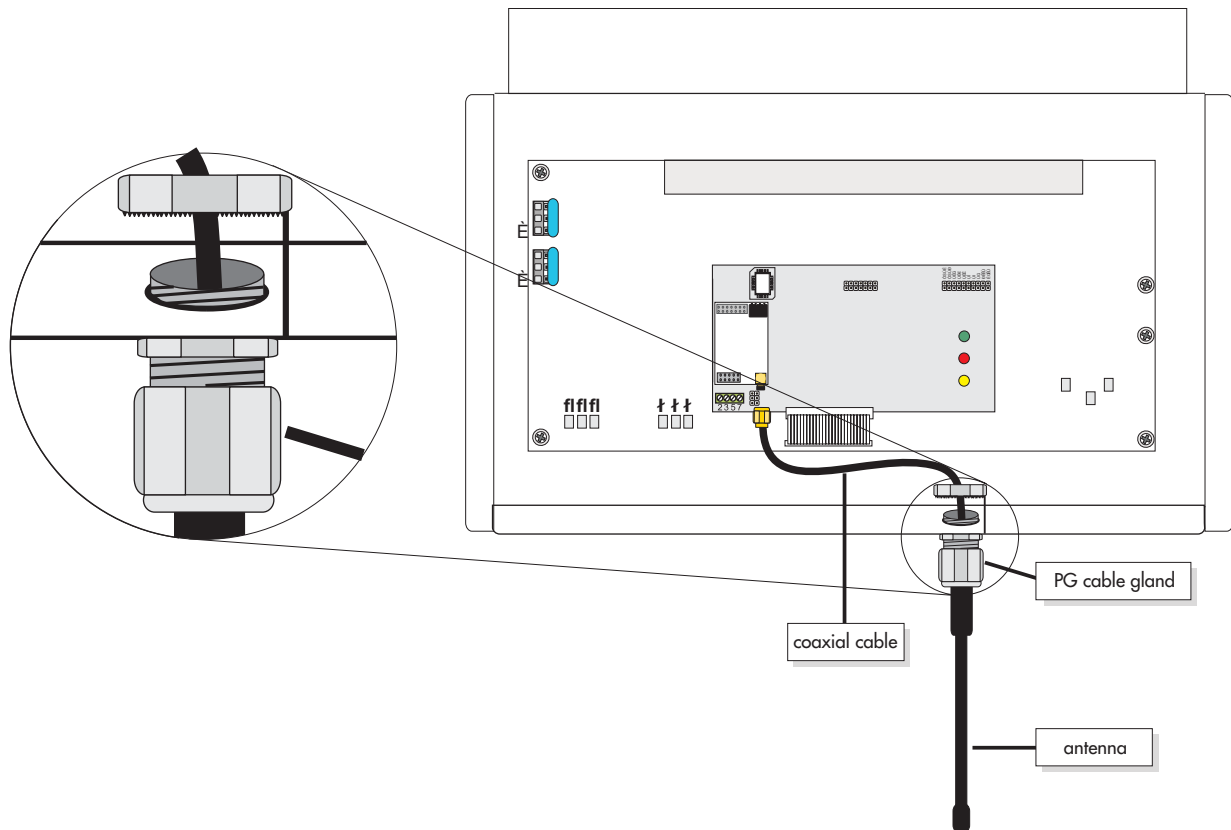

Figure 1-6 Mounting the Antenna to the Inverter

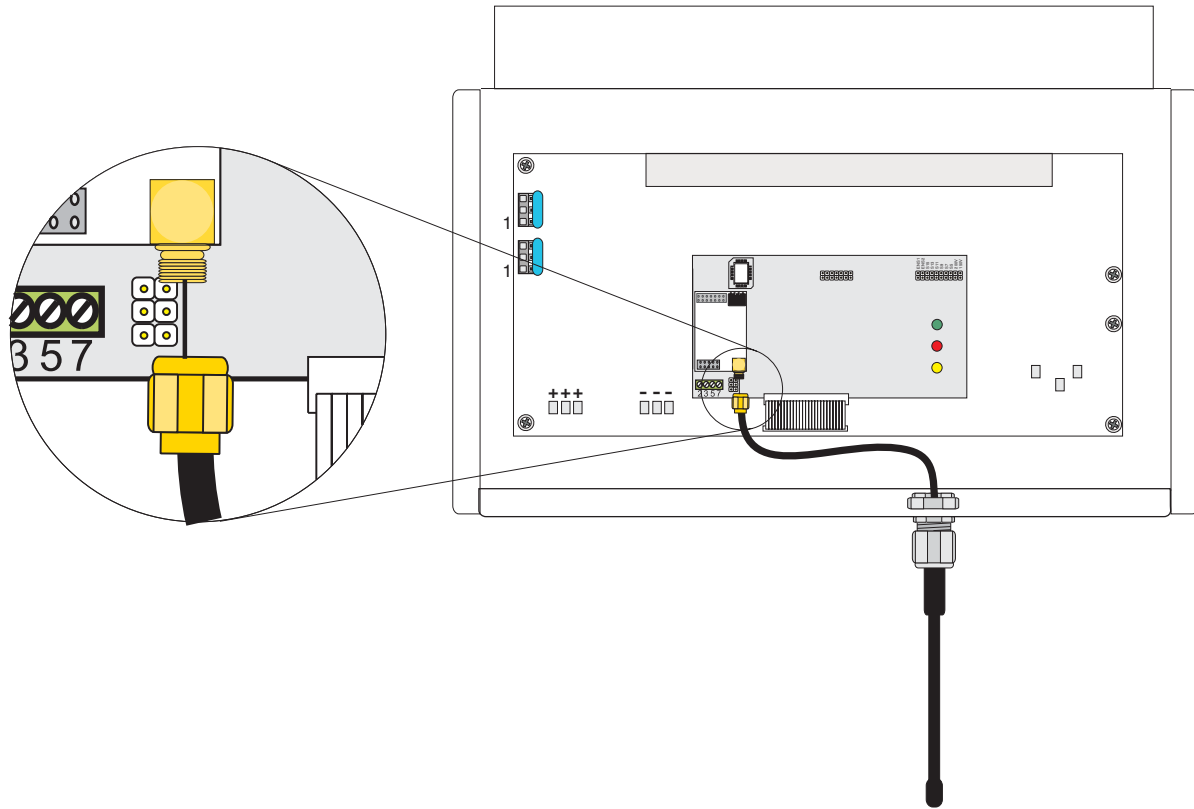

Figure 1-7 Connecting Coax to Radio Piggy-Back

Repeat this process for the remaining inverters if applicable. Once the installation of the Radio Piggy-Backs is complete, restore power to the inverters.

Wall Mounting the Sunny Beam

The Sunny Beam is design to work as a desktop unit. However, in some applications, it may be desirable to mount the Sunny Beam to a wall. A wall-mount bracket has been provided for this purpose.

Mount the wall bracket securely to the wall using appropriate hardware for the wall material.

Set the top of the Sunny Beam onto the tab at the top of the wall bracket.

Bring the Sunny Beam down towards the bottom of the wall mount. Then pull down on the Sunny Beam enough to clear the two tabs at the bottom of the wall bracket and set the two tabs into the slots on the bottom of the Sunny Beam.

To remove the Sunny Beam, simply reverse the process.

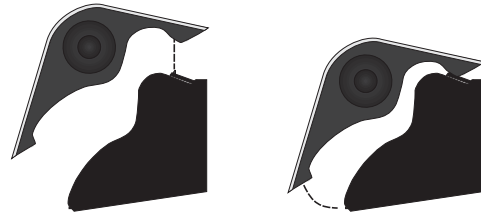

Commissioning

Navigation

In order to commission, setup and use the Sunny Beam it will be necessary to navigate through assorted screens and menus. This is accomplished through the use of a rotary push-button type knob on the side of the Sunny Beam. This knob functions as follows:

Rotate the knob to:

- Move the cursor up and down on menu screens
- Increase, decrease values or scroll through menu item settings
- Scroll through the display screens

Press the knob to:

- Enter the menu mode
- Select a highlighted item

Sunny Beam External Antenna Position

The external antenna on the Sunny Beam has a built-in hinge. Bend the antenna at the hinge and position it so that it is straight up. This will be the most effective position for most installations.



NOTE: Do not rotate (other than where hinged), loosen or remove the external antenna from the Sunny Beam. Operating the Sunny Beam without the antenna will damage the Sunny Beam and void the warranty.

Installing the AA Batteries

To begin the setup process, install the pair of AA batteries included with the unit. Remove the battery compartment cover located on the bottom of the Sunny Beam and insert the AA batteries. Be careful to observe proper polarity.



NOTE: Only the batteries supplied with the Sunny Beam should be used. If it becomes necessary to replace the batteries in the future, replace with the same size and type. (AA Rechargeable Alkaline)



NOTE: The Sunny Beam may begin to operate before the batteries are inserted if exposed to sunlight. The batteries must still be inserted for the Sunny Beam to function properly. The solar cell is design to help keep the batteries full, but not energize the entire unit.



NOTE: To make the installation of the AA batteries easier, insert the positive (+) end of the cell first.

Once the batteries are inserted, replace the battery compartment cover. The Sunny Beam will turn on automatically and enter setup mode.

Setup

Set Date and Time

When the Sunny Beam is first powered up it will begin with setting the date and time.



NOTE: This is a good opportunity to become familiar with the operation of the knob. Notice how the selected item changes as the knob rotates. Once the correct value is displayed, press the knob to select it.

To set, follow these instructions:

- Rotate the knob so that DAY is highlighted. (Indicated by a box around the entire line-item)
- Press the knob to select DAY
- Rotate the knob until the proper date is showing
- Press the knob to set DAY
- Rotate the knob so that MONTH is highlighted
- Press the knob to select MONTH
- Rotate the knob until the proper month is showing
- Press the knob to set MONTH
- Repeat this process for the remaining items
- When finished, highlight EXIT and press the knob

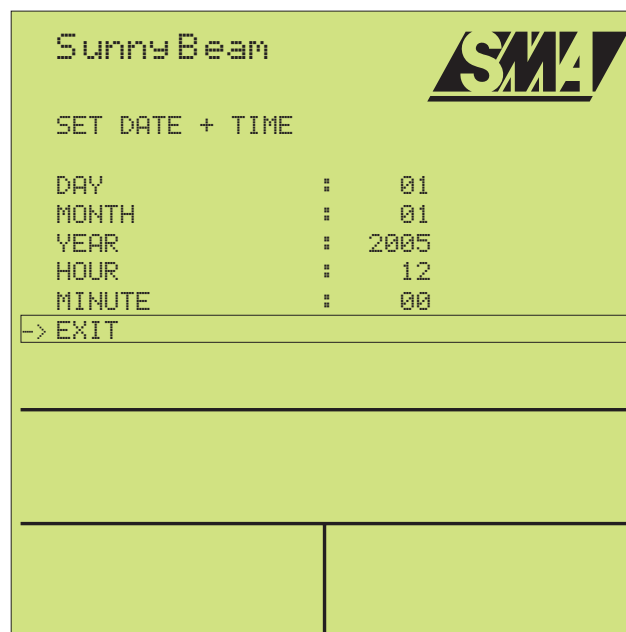

Figure 1-8 Setting the Date and Time

Sunny Boy Detection

Once the date and time are set the Sunny Beam will automatically begin to search for active inverters. While the Sunny Beam is searching, the radio frequency, or “group” number is displayed along with the number of inverters found.



NOTE: The Sunny Beam should be kept a minimum of 10 feet away from the Sunny Boy during the detection process to avoid overloading the receivers.

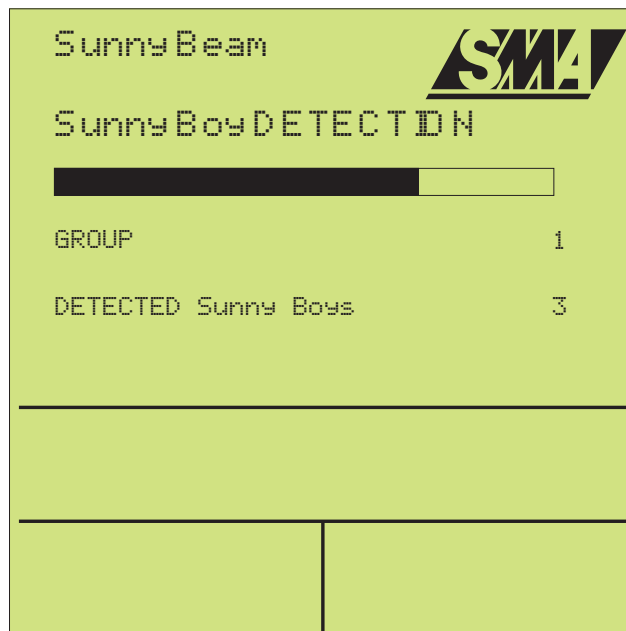

Figure 1-9 Sunny Boy Detection Process

Excluding Inverters

Once the Sunny Beam has finished searching for inverters, it will display the inverters found and show their type and serial numbers. This screen provides an opportunity to exclude certain inverters. For example, if the Sunny Beam can detect inverters that are not part of the plant or if it detects inverters that will not be monitored at this time, the undesired inverters would be excluded during this step.

To exclude an inverter, rotate the knob so that the inverter to be excluded is highlighted, press the knob to select the inverter. When excluded, the Sunny Beam will strike-through the inverter's information. See the illustration below. If no inverters are to be excluded, select Proceed to Registration.



NOTE: The Sunny Beam allows manual detection of inverters at anytime so excluded inverters can be added when desired.

Proceed to Registration: Once any excluded inverters are selected, continue to the registration process to complete the setup.

Find More Devices: Instructs the Sunny Beam to continue to search for more inverters.

Cancel: Select cancel to exit this process.

Once this process is complete, the Sunny Beam will display the home screen and begin normal operation.

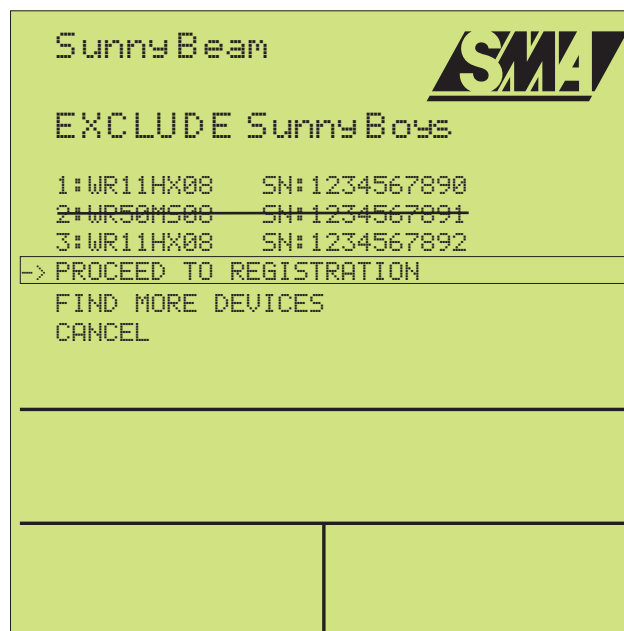

Figure 1-10 Excluding Inverters During Startup

Operation

Power Supply

The Sunny Beam operates off of the pair of AA batteries inside the unit. These batteries are recharged by the solar cell on the back of the Sunny Beam, or via the USB port with a powered USB hub or special USB wall-charger.

Power Level Indication

The power level of the internal batteries is displayed on the home screen in the form of a small battery cell icon. At 3.30 V the icon indicates “full” and at 2.50 V the icon indicates “empty”.

If the battery voltage falls below 2.60 V, the “P” in the word Power on the display begins to blink signifying low battery. The Sunny Beam will continue to operate when the “P” is blinking.

If the battery voltage drops below 2.50 V, the Sunny Beam will shut down. The display will remain blank, but every 10 seconds the Sunny Beam wakes up and checks the battery voltage. Once sufficient power is available the Sunny Beam will restart automatically.

Recharging the Batteries

The internal batteries are typically kept charged by the solar cell on the back of the Sunny Beam. For best results, the Sunny Beam should be located where the solar cell will be exposed to sunlight. If the location of the Sunny Beam is not exposed to sunlight, anticipate placing the Sunny Beam in direct sunlight from time to time to recharge the batteries.

The batteries may also be charged via the USB port. To charge the batteries via the USB port, connect the USB cable supplied with the Sunny Beam to the USB port on the side of the unit. The USB cable then needs to be connected to a USB power source such as a powered USB hub or the optional USB power supply available from your SMA dealer. Once connected, the Sunny Beam will display the USB symbol on the display and charge the internal batteries as needed.

The Home Screen

The Home Screen is what the Sunny Beam will display under normal operating conditions. There are several options that the Sunny Beam can be set to display on this screen. The Home Screen can display in text:

- Total power output of the plant and individual inverters
- Percentage of P-Limit
- Device Type of inverters
- Serial Number of inverters
- Earnings in desired currency
- CO2 Saved
- Date and time

The Home Screen can also display the following information in graph format:

- Daily total plant power output
- Daily single inverter power output
- Daily total energy yields for the last 31 days or of the current month
- Internal battery voltage level

Default View

The Sunny Beam comes set from the factory to display the daily yield and total yield of the entire plant in the text area. The total plant power for the day is displayed in the graph area. The same data for the individual inverters can be displayed by rotating the knob.

Scrolling Through Screens

When scrolling through screens, the Sunny Beam shows first the combined output of all inverters being monitored. Then, by rotating the knob one click, it shows the individual power outputs for the individual inverters. For example, if there are two inverters, it shows: Combined power, inverter 1 power out, inverter 2 power out. Then it shows combined energy yield followed by the individual energy yields for each inverter. This sequence repeats for any of the parameters that are selected to be displayed.

When the home screen is displayed, any activated parameters will be shown in the black bar beneath the graph. Each item will be displayed briefly before the Sunny Beam automatically scrolls to the next item.



NOTE: The graph shows the power output of the plant or individual inverters over the course of the day. If at any time the Sunny Beam fails to communicate with any of the inverters, that portion of the graph will be grayed out.

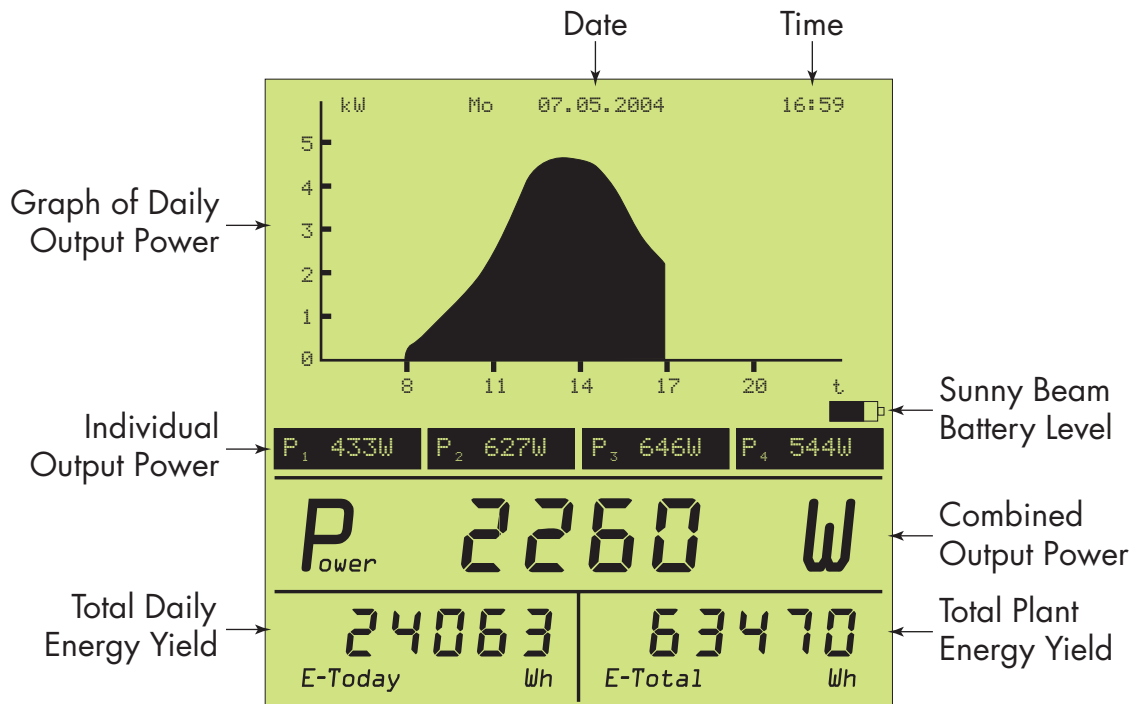

Figure 1-11 Home Screen Display Details

Auto Scaling

The graph will automatically scale the x and y axis throughout the day depending on power output. For example, as the power output increases during the morning, the Sunny Beam rescales the graph automatically so that the peak always remains displayed.

Monthly Data

The total power output for each of the inverters is stored for viewing in the Daily Energy Yield screen. By rotating the knob, the total for each inverter as well as the total for the plant can be viewed.

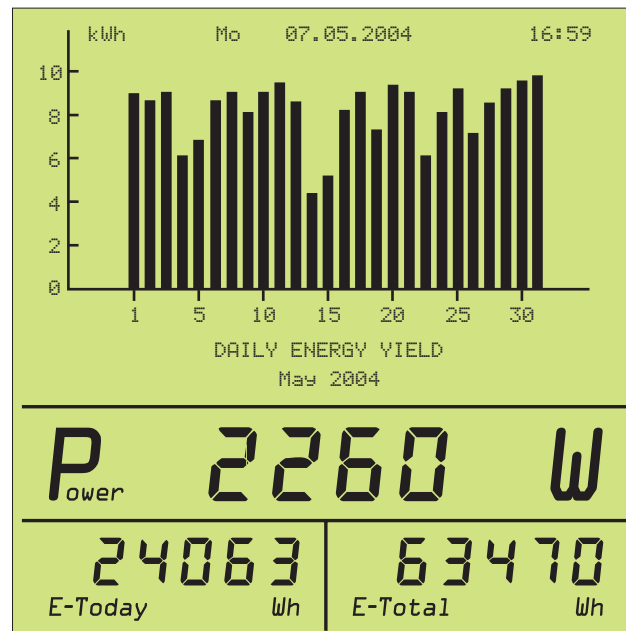

Figure 1-12 Daily Energy Yield

Home Screen Display Options

In addition to the factory set of display options, there are several additional types of information that can be displayed. The following examples show the different parameters that are available.



NOTE: Instructions on how to activate each of these options is in the following section under Data View.

Percentage of P-Limit

The power output is displayed as a percentage, calculated from the current output power of the inverter divided by the maximum output power. The individual inverters are selectable by rotating the knob.

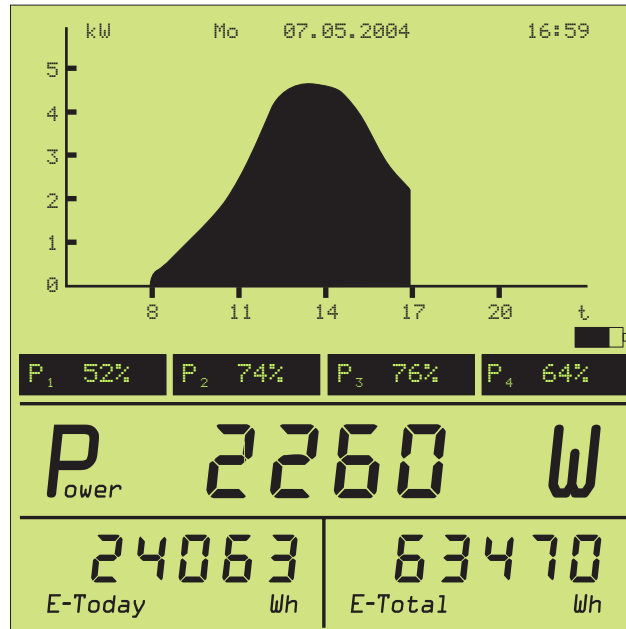

Figure 1-13 Percentage of P-Limit of All Inverters

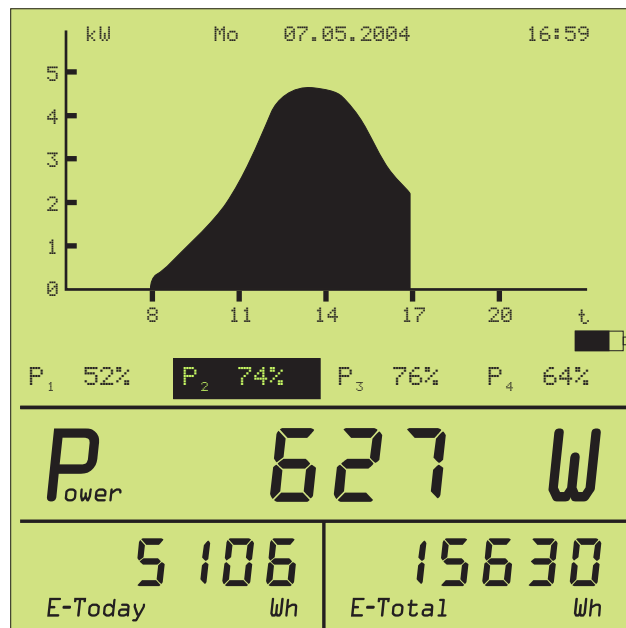

Figure 1-14 Percentage of P-Limit Individual Inverter

Device Type

The Device Types of the connected inverters are displayed in this screen. When an inverter's device type number is displayed, its power values are displayed in the black bar beneath the graph.

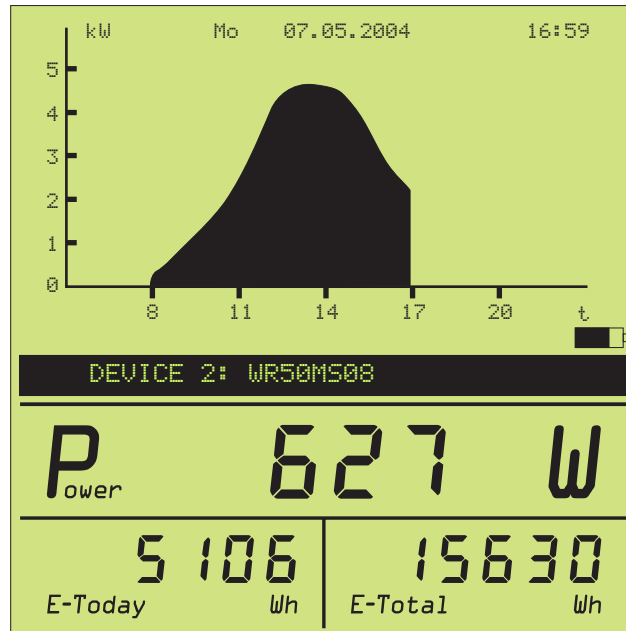

Figure 1-15 Device Type Display

Serial Number

The serial numbers of the connected inverters will be displayed along with their corresponding power values. This is helpful in determining the actual inverter being monitored.

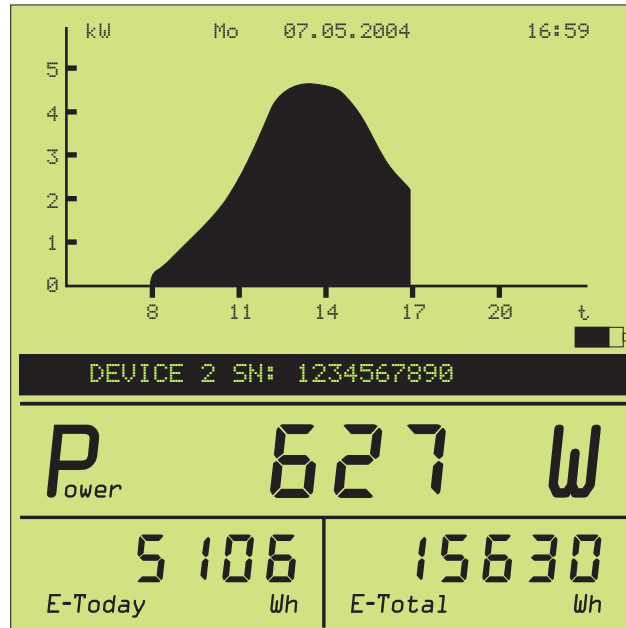

Figure 1-16 Serial Number Display

Earnings

The earnings are displayed in the desired currency. The setting of the currency and the remuneration is explained in detail in the Coefficients of Balance section of this manual.

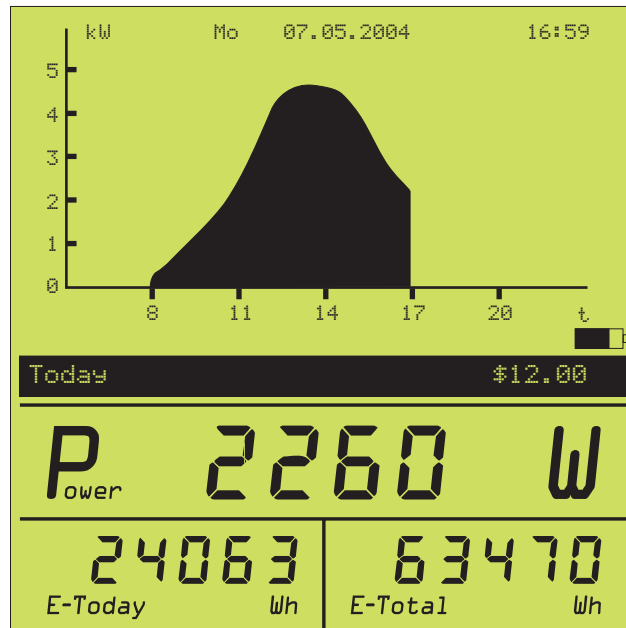

Figure 1-17 Earnings Display

CO2 Saved

In this screen the amount of CO2 saved by the operation of the plant is displayed in kilograms. The formula for this is based upon selections made in the Coefficients of Balance setup.

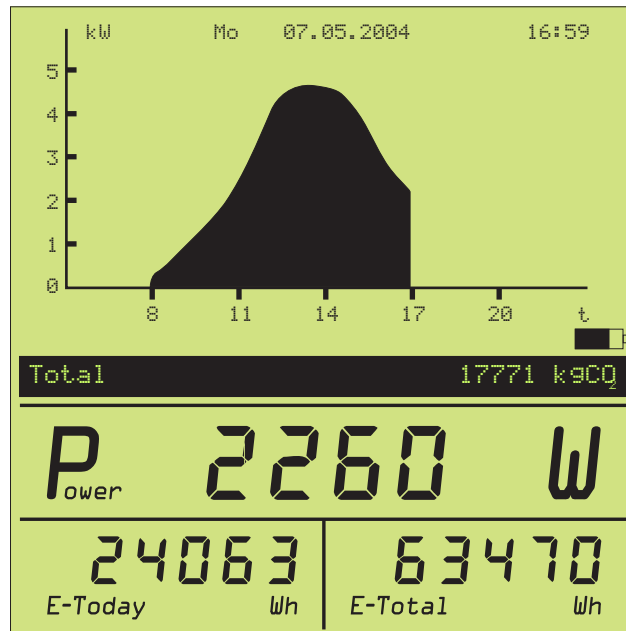

Figure 1-18 CO2 Saved Display

Setup Options

Main Menu

To access the different setup options for the Sunny Beam, begin by going to the Main Menu. This menu is reached by pressing the knob once while in any of the home level screens. This section describes the functions of each of the Main Menu items.

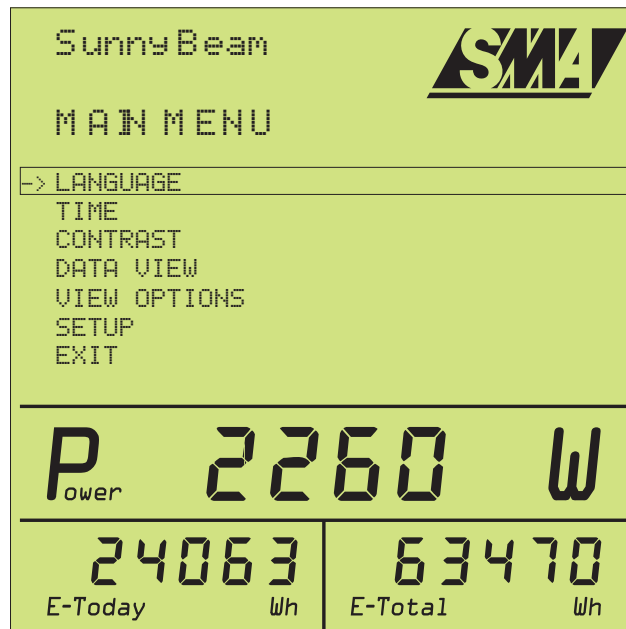

Figure 1-19 Main Menu

Language: As described earlier, the Language menu allows the user to choose between English, Spanish or German.

Time: The Time menu allows the user to set the time and date in the Sunny Beam.

Contrast

The Contrast menu allows the contrast of the screen to be adjusted for best visibility. There are separate settings for the upper screen and the lower screen. Adjust for the best view in the surrounding light conditions.

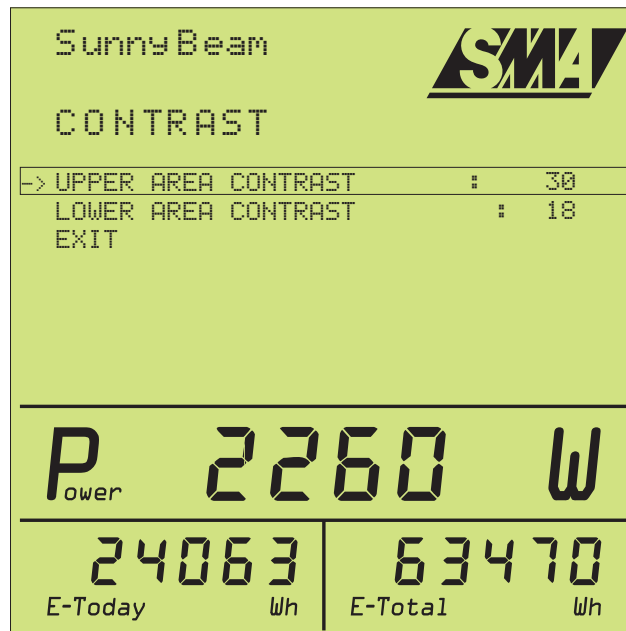

Figure 1-20 Setting the Contrast

Data View

The Data View menu is used to select which items are to be displayed. The check mark indicates that the item will be shown on the home screen. Use the knob to select and set the options to be displayed and then select Exit to return to the main menu.

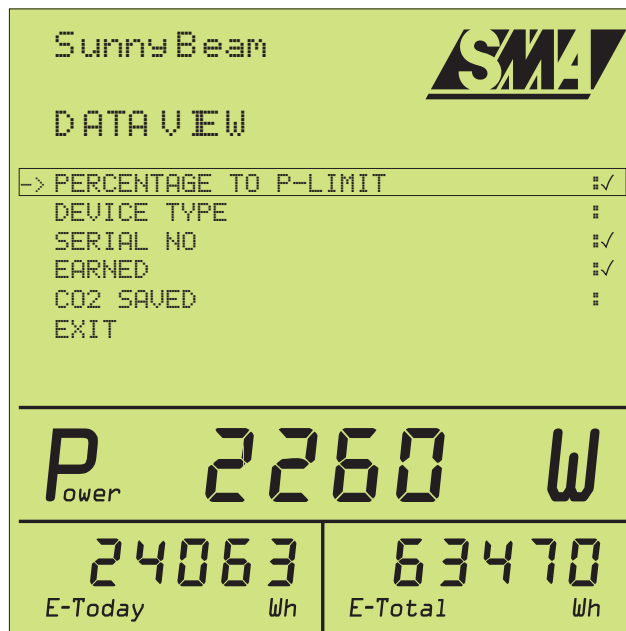

Figure 1-21 Data View Menu

View Options

The View Options menu allows the interval at which the data is updated to be adjusted.

Data Change Freq.: Sets the interval at which the data on the screen is updated. This can be set from 5 to 30 seconds.

Data Request Freq.: Sets the interval at which data is requested from the Sunny Boy inverter. This can be set from 10 seconds to 60 minutes.

Display Off Delay: Sets the amount of time the Sunny Beam will wait during inactivity before shutting off the display to conserve power.

History: Selects whether the historical data is displayed for the last calendar month (1 M) or last 31 days (31D).



NOTE: These settings greatly effect the overall energy consumption of the Sunny Beam. For longer battery life, set longer Data Request times and shorter Data Change and Display Off times.

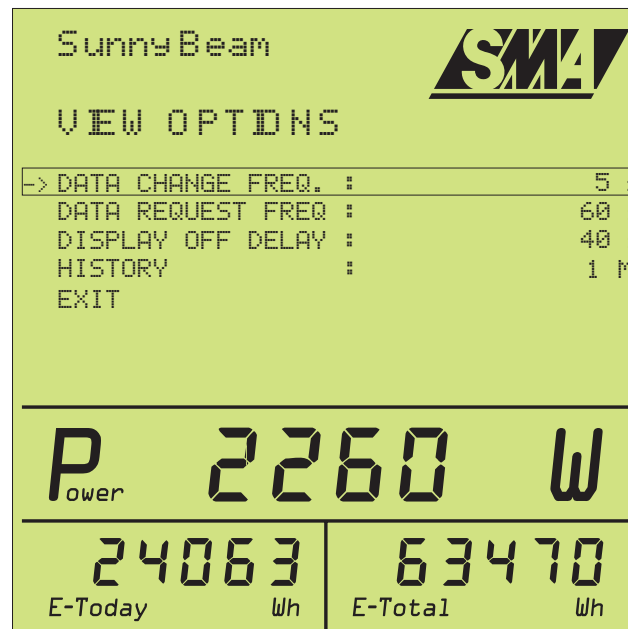

Figure 1-22 View Options Menu

Setup Menu

The Setup menu allows for further customizing of the Sunny Beam.

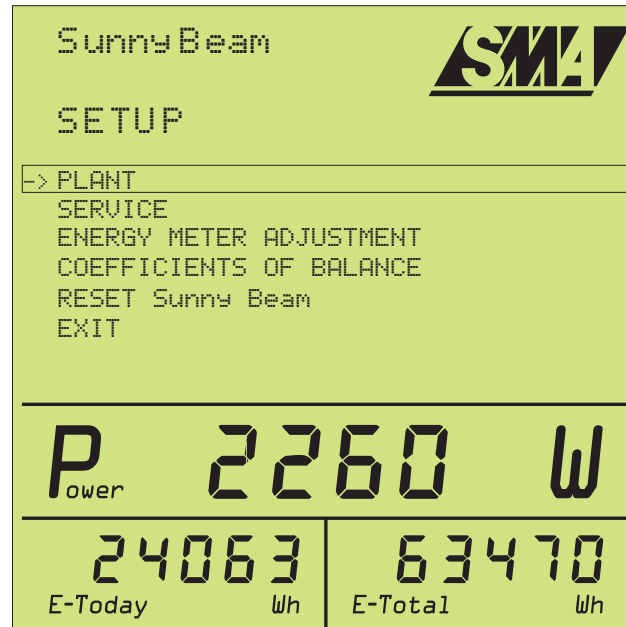

Figure 1-23 Setup Menu Items

Plant

The plant menu allows changes to be made in the number of inverters being monitored and the radio frequency being used. The following three items are found in the Plant menu:

Sunny Boy Detection: This will initiate another detection routine in which any of the inverters on the same frequency or “group” and within range of the Sunny Beam will be detected and displayed. This routine allows inverters to be added or removed to the list of inverters monitored by the Sunny Beam. The Sunny Beam can monitor up to 4 inverters at a time. For monitoring more, see Group below for information on setting up groups of inverters.

Exclude Sunny Boys: Choose this option manually to remove any undesired inverters from the Sunny Beam’s list. Or, anytime after a detection of inverters is completed, this option is automatically available and any undesired inverters may also be excluded at that time.

Group: The Group screen allows selection of the operating Group. The Sunny Beam comes set from the factory on Group number 1. This setting will work for most applications. In the event of interference, it is sometimes possible to cure it by changing the Group number. It is also possible to monitor another “group” of inverters using this function. For example, if a system had 8 Sunny Boy inverters, each with a wireless piggy-back card, the first group of 4 would

be set to Group 1. The second set of 4 would be set to Group 2. Then, by changing the Group number in the Sunny Beam between 1 and 2, each set of 4 inverters could be monitored separately.



NOTE: Only one group of inverters is monitored at a time. For example, if the Sunny Beam is set to Group 1, then only those inverters (up to 4) set for Group 1 are monitored. No data is being retrieved or stored for any other group until the Sunny Beam is set for that Group number.

Service

The Service menu contains items used in troubleshooting and performance related issues.

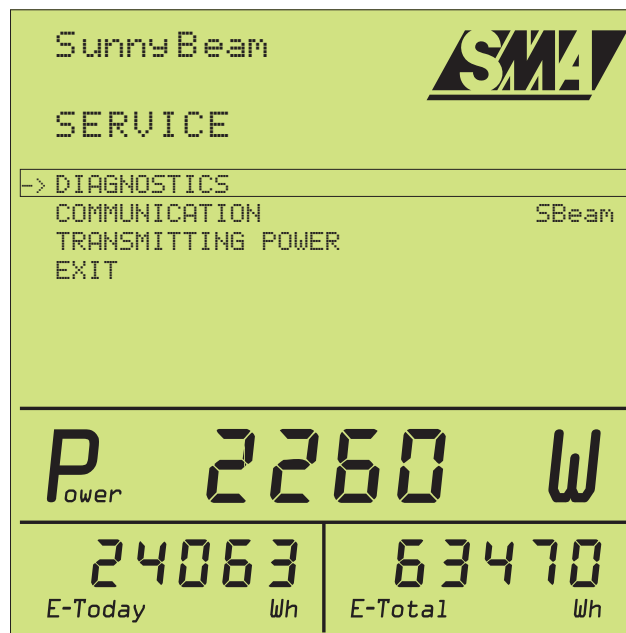

Figure 1-24 Service Menu

Diagnostics

The Diagnostics screen provides information on the communication performance of the Sunny Beam and can be very helpful in troubleshooting communication issues. When this screen is entered, the Sunny Beam begins transmitting requests for data to the Sunny Boy(s). The Sunny Beam records the successes and failures of these communication requests as described below.

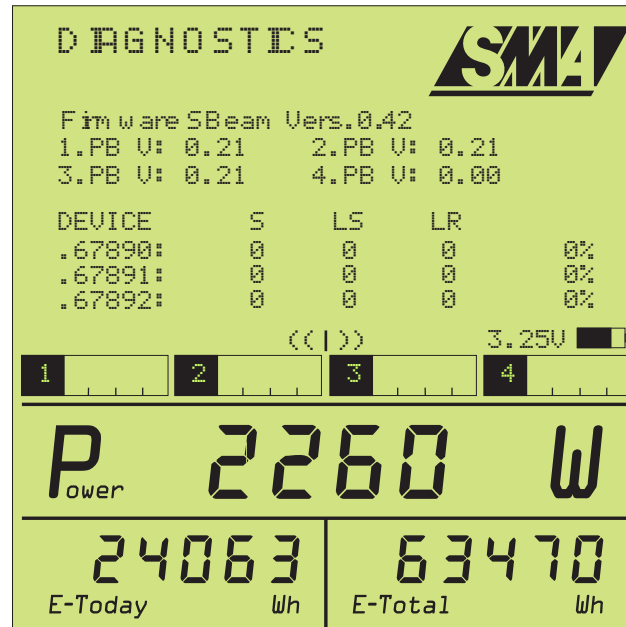

Figure 1-25 Diagnostics Screen

Firmware SBeam: Displays the current version of the firmware installed in the Sunny Beam.

1.PB, 2.PB, 3.PB, 4.PB: Shows the firmware version for each of the installed piggy-back cards.

Device: Shows the last 5 digits of the Sunny Boy serial number for unit identification.

S, LS, LR: Displays the number of information packets being transmitted and received for analysis.

S: Displays the number of requests for data being sent by the Sunny Beam to the Sunny Boy.

LS: Displays the number of requests sent by the Sunny Beam to the Sunny Boy that the Sunny boy did not receive. In other words, the Sunny Boy can not “hear” the Sunny Beam. The Sunny Beam may be too far away from the inverter. Ideally, this number should remain at zero.

LR: Displays the number of requests that were confirmed by the Sunny Boy but weren’t received by the Sunny Beam. In other words, the Sunny Beam is having difficulty “hearing” the Sunny Boy and may be too far from the inverters. Ideally, this number should remain at zero.

The Percentages: Displays the success rate of the communication. Ideally this number would remain at 100% indicating that all requests for data were completed. If this number was 50%, it would mean that half of the time the Sunny Beam is unable to complete a request for data with the Sunny Boy. If the number is 0%, it means that the Sunny Beam is unable to communicate with any of the inverters and needs to be moved closer.

The “transmit arrow” in the center of the screen: This arrow illuminates whenever the Sunny Beam transmits a request for data.

The Bar Graphs: The bar graphs display the relative field strength of the signal being received from the Sunny Boys. In other words, it graphically displays how well the radio signal from the Sunny Boys is being received. Ideally, these bar graphs should light across the entire scale indicating full strength. This makes it easy to determine if all of the inverters being monitored are being received equally.

To leave the Diagnostics screen, press the knob.

Communication

The Communication menu is used when setting up the Sunny Beam for use with a PC running Sunny Data Control.

SBeam: When connected to Sunny Data Control, only the information on the Sunny Beam will be displayed. (Power output, daily yield, total yield)

Plant: Allows data from the Sunny Boy inverters to be displayed on a PC via Sunny Data Control. Selecting this mode will allow the information in the inverters and the information in the Sunny Beam to be displayed.



NOTE: No matter which setting is selected, only data for the entire plant is recorded. Individual inverter data is displayed, but not recorded.

Transmitting Power

Firmware versions 2.16 and earlier, have an item in the Setup menu called Transmitting Power. There are two possible settings: norm and test. The power levels for both the inverter(s) and the Sunny Beam should be set to **test**. The transmit power for the inverter(s) is set by a command from the Sunny Beam. To change the power levels, the Sunny Beam will need to be within radio range of the inverter(s) and the inverter(s) will need to be operating at the time. Be sure to save the changes when prompted to do so after exiting the menu.

Energy Meter Adjustment

The energy meter for each of the Sunny Boys can be adjusted in the Sunny Beam if required. For example, this would allow an inverter used in a previous system to start out at zero, or conversely, restore the values if the inverter was off-line for any reason.

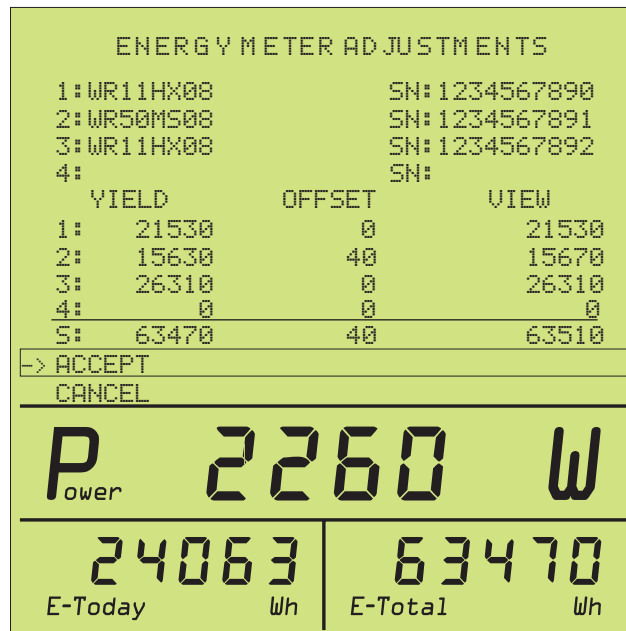

Figure 1-26 Energy Meter Adjustment

To adjust an energy meter for an inverter, use the knob to scroll up to the inverter to be modified. Press the knob to select the inverter. Then rotate the knob until the desired offset is reached. Press the knob to set it, then scroll to ACCEPT and press the knob to save the setting.

Coefficients of Balance

This menu allows the price per kilowatt hour and the type of currency to be selected. This also determines the formula for the Earnings display. The kilograms of CO₂ saved per kilowatt hour can also be set. The factory default for kg CO₂ / kWh is a factor of 1.70.

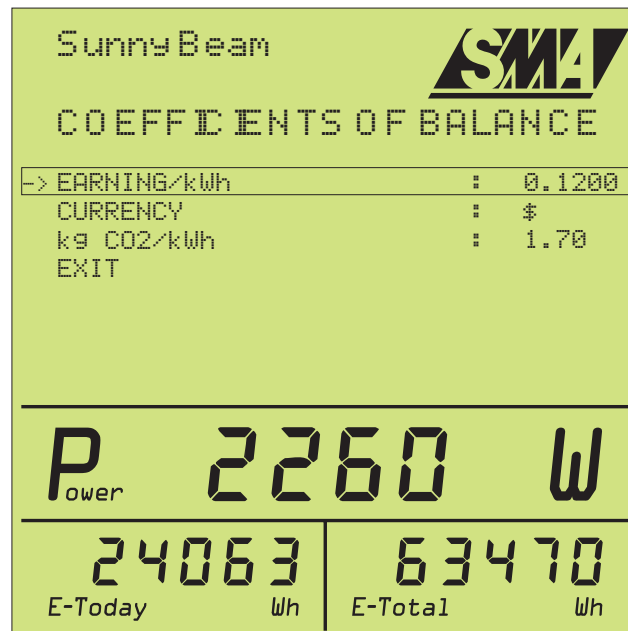

Figure 1-27 Coefficients of Balance

Reset Sunny Beam

Resetting the Sunny Beam will restore everything in the Sunny Beam to zero except for the time and date. All other data will be erased. Select RESET Sunny Beam and there will be a prompt for confirmation before the Sunny Beam resets itself.

Using the USB Port

The Sunny Beam has a built in USB port on the side of the unit. This port may be used to charge the internal batteries or communicate with a PC using Sunny Data Control. When the USB is active, a USB symbol will appear on the display.

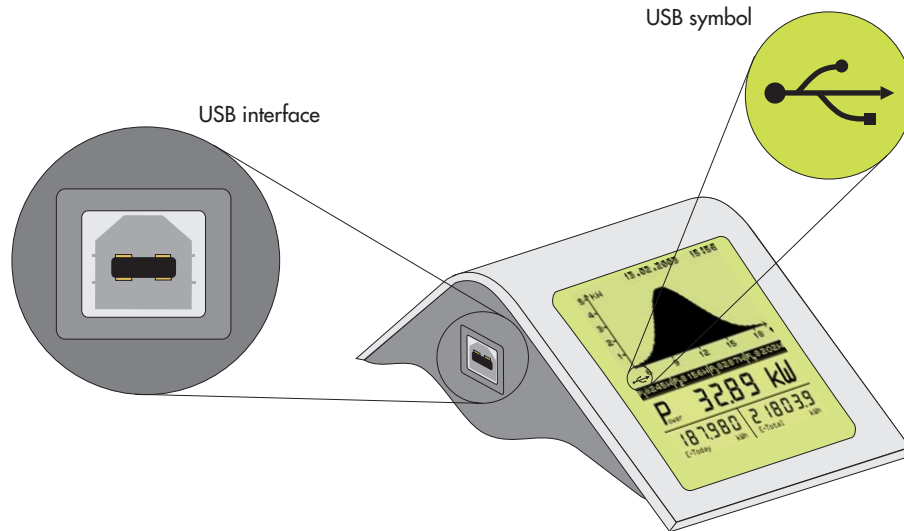

Figure 1-28 USB Port and Symbol on Display

Sunny Data Control

Setup

The Sunny Beam comes with a CD-ROM which includes a copy of the Sunny Data Control (SDC) software as well as the driver for the Sunny Beam. Before using the Sunny Beam with a PC, the SDC software and driver must be installed. Refer to the instructions packaged with the software for installation and system requirements. Once installation is complete, leave the CD in the drive so that the driver for the Sunny Beam can also be installed in the next steps.



NOTE: SDC will not communicate with the Sunny Beam unless at least one Sunny Boy inverter has been detected and registered by the Sunny Beam.

Begin by setting the Sunny Beam to "Plant" as described under Communication on Page 30.

Connect the USB cable to the Sunny Beam and then plug the USB cable into the PC.

The PC will auto-detect the Sunny Beam and then ask for a driver. Simply point the PC to the CD-ROM drive and it will automatically detect and install the correct driver.

Once launched, SDC will display the overview screen. See the following figure.

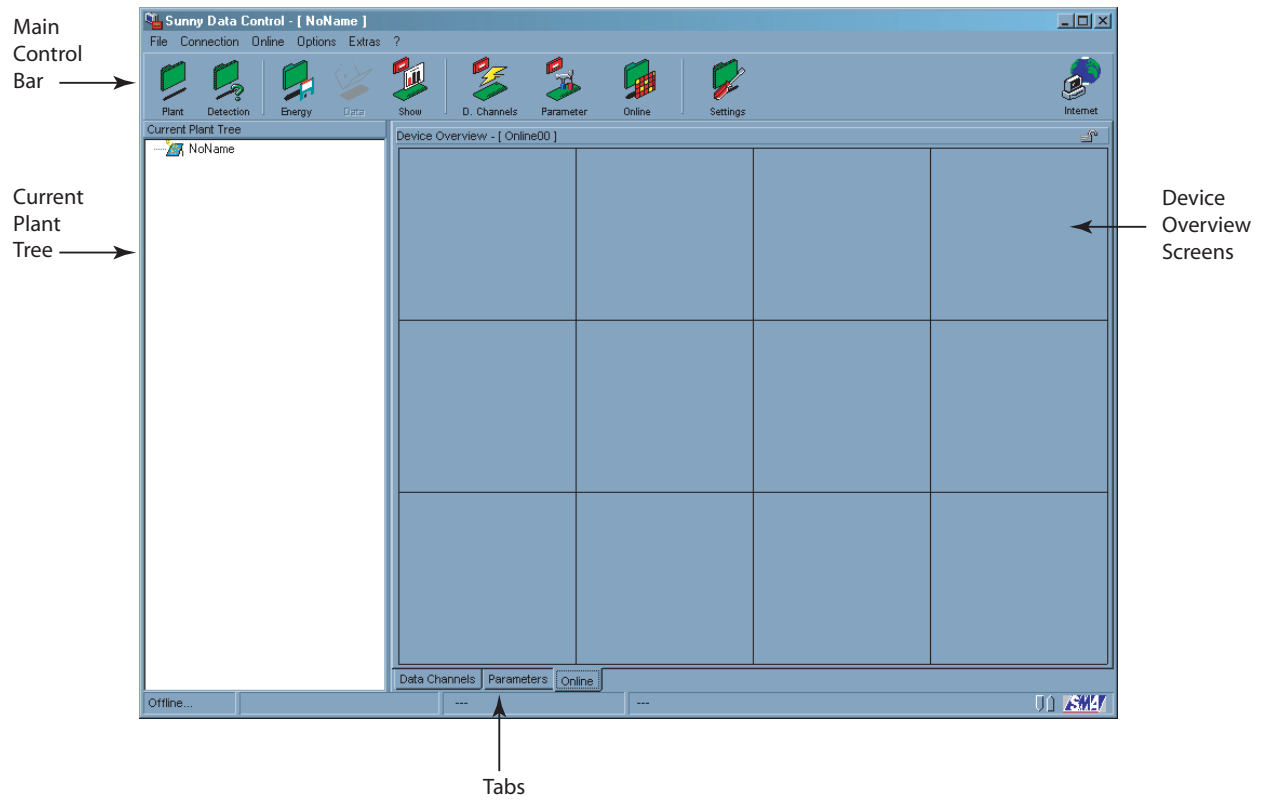

Figure 1-29 Guide to SDC Overview Screen

Detecting the Sunny Beam

Once SDC is launched, The next step is to select the proper port for SDC to communicate through. To set up the port, click on Settings in the main control bar and then under "Connection By" select Sunny Beam (USB) as shown below. Click OK to exit.

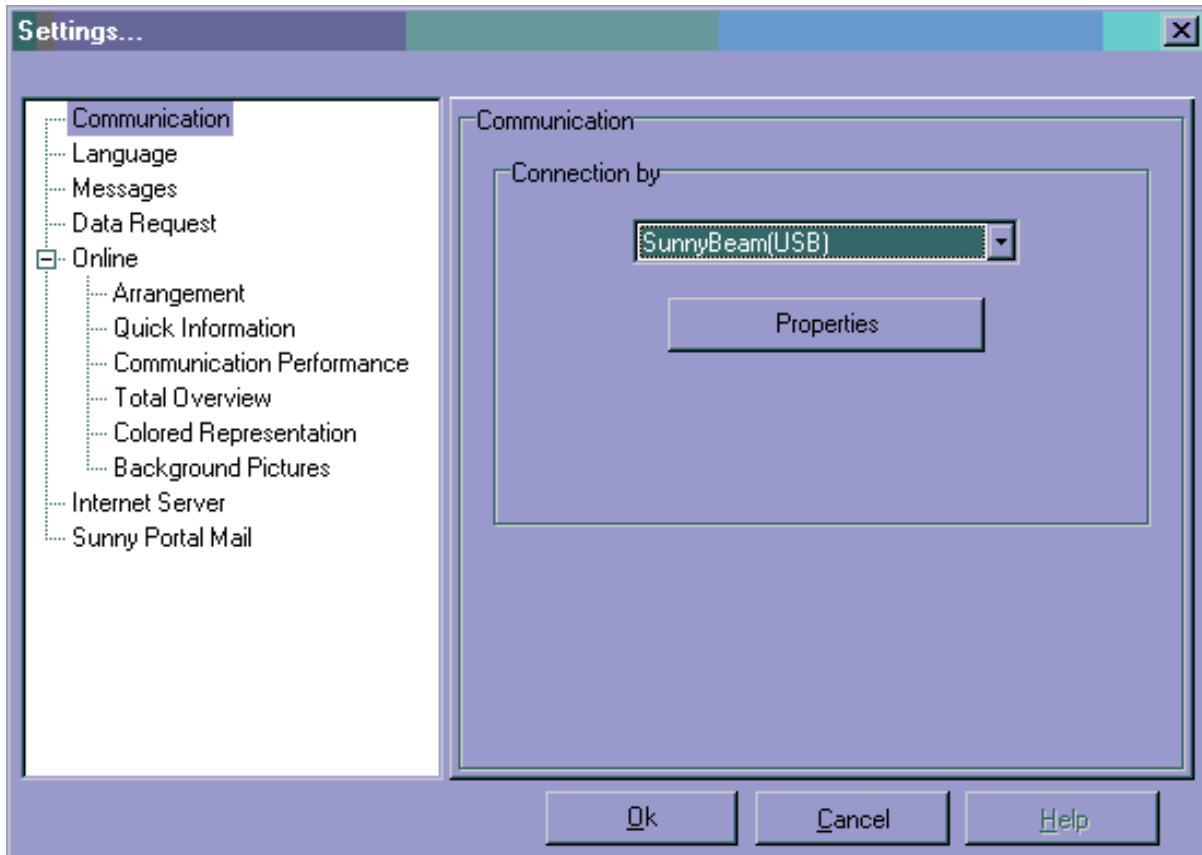

Figure 1-30 Sunny Data Control Settings Window

The next step is to detect the Sunny Beam and the inverters. To do this, click on Detect in the upper control bar. SDC will begin downloading the device information automatically. This may take a few minutes to complete. Once completed, click OK to exit.

Data Channels

The next step is to set up the Sunny Beam data channels to be viewed. This is done by clicking on the Data tab at the bottom on the main window in SDC. Then, in the left window called Current Plant Tree, open the Sunny Beam. Then open the Measuring channels. Drag each of the memory channels to be monitored into the main SDC window. Refer to the following Figure.



NOTE: If the Sunny Beam is not set to "Plant" mode, only the Sunny Beam will be detected and only its information displayed. To set the Sunny Beam to "Plant", see Communication on page 30.

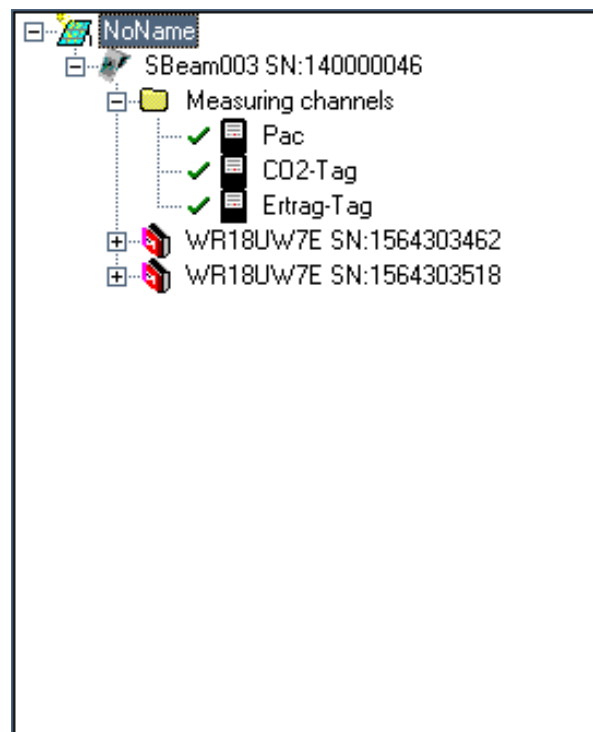

Figure 1-31 Current Plant Tree Window with Measuring Channels

Download and View Stored Data

Once the channel selection is complete, click on Data and SDC will download the data automatically. The downloaded data is exported by SDC to Excel. To view the data, click on Show in the upper control bar. There you will see each of the files of data that can be viewed. Simply double-click on a file to launch Excel and view the file. It is recommended that the Macro feature be enabled when viewing the data files.

The Data button will download:

- Pac at 10 minute intervals
- Total CO2 offset for the day
- Total Energy for the day

Pressing the Energy button will display the Energy total for the last month/31 days.



NOTE: The daily data collected by the Sunny Beam is only stored in the Sunny Beam until the beginning of the next day. Therefore, if it is required that the daily totals be downloaded from the Sunny Beam, it needs to be performed before the inverters restart the following morning.

Real-Time Data

To view real-time data, click on the Online tab at the bottom of the main SDC window. Then, right-click in the upper left gray box and select Fade in Devices, and All Devices. SDC will now show the data for the devices being monitored. Refer to the figure below.

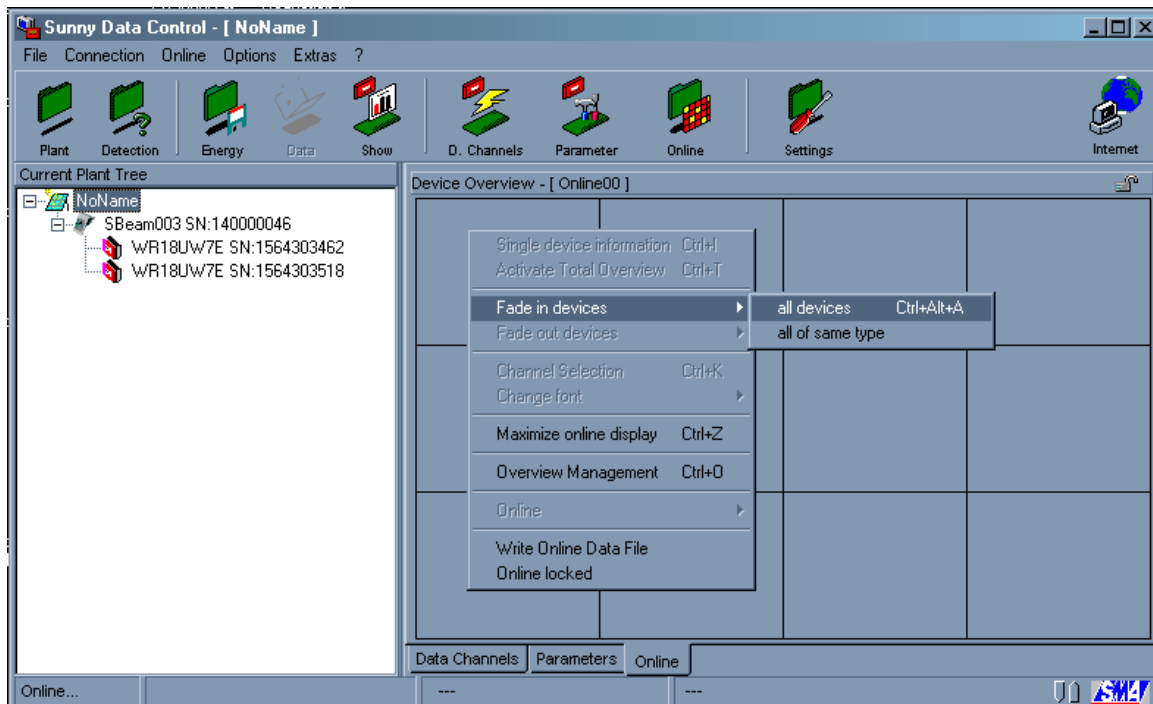

Figure 1-32 Fading in Devices

Window Setup

Once the devices are displayed, the channel information for each device can be customized. It is easier to read the display in SDC if the number of boxes shown is limited to the number of devices. To do this, click on Settings in the upper control bar. Under Arrangement, set the number of rows and columns needed. Refer to the following figure.

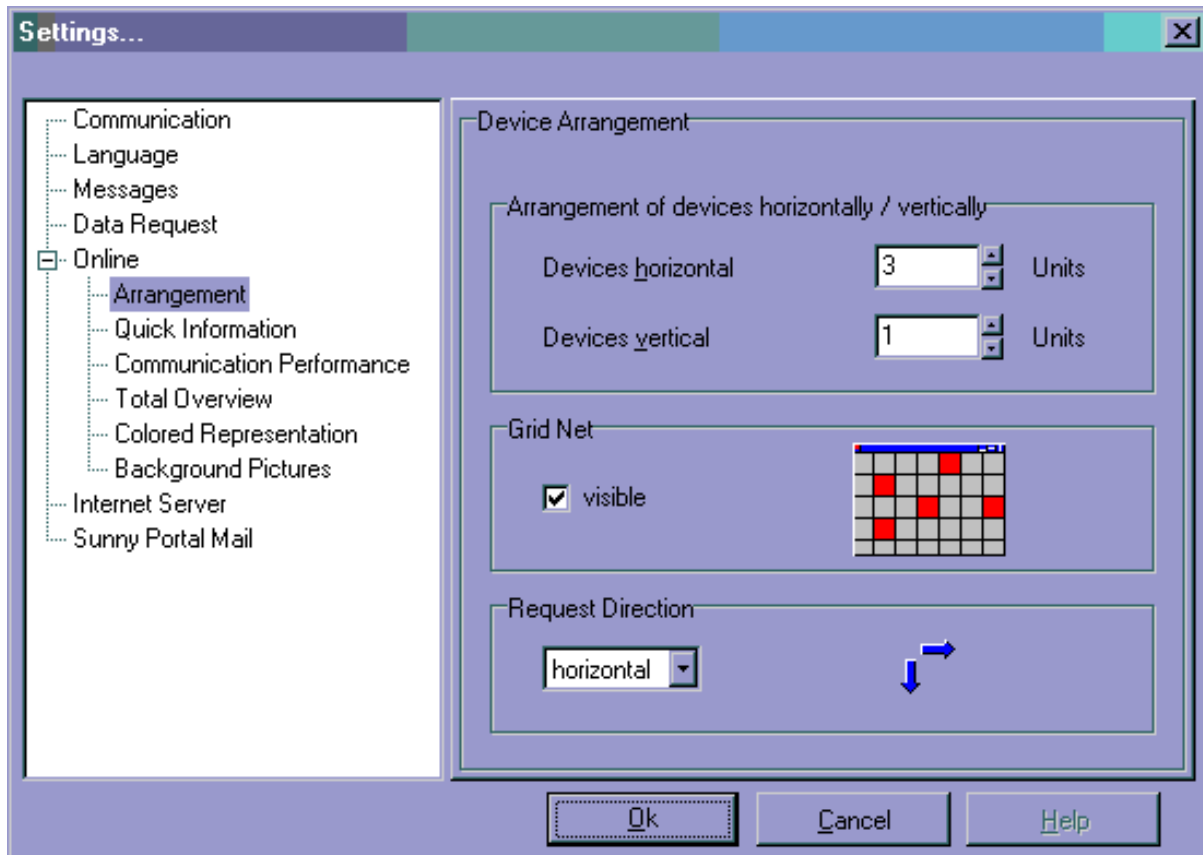

Figure 1-33 Arrangement of the Device Windows

When the proper selections have been made, click OK to exit. Then, if there were two inverters and the Sunny Beam being monitored, the SDC Device Overview window might look like this:

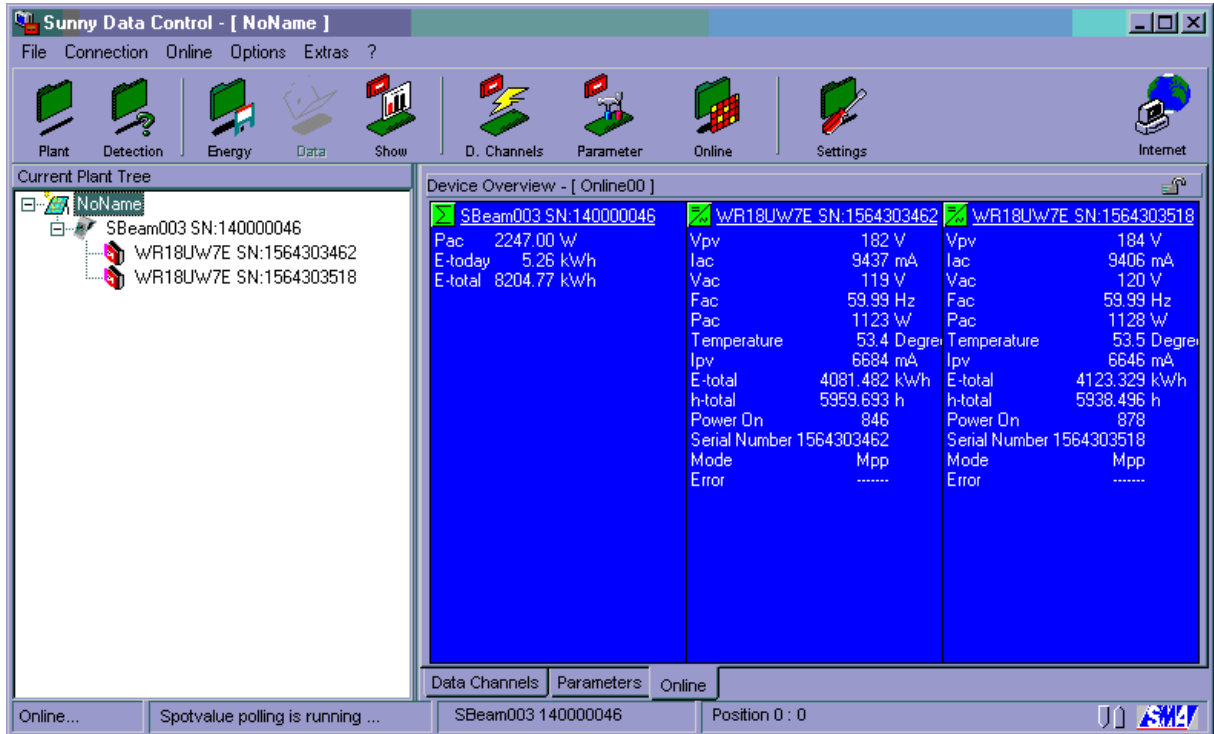

Figure 1-34 Example of One Window per Device

Once the windows are setup, the individual channels can be customized by right-clicking in the window of the device to be modified and selecting Channel Selection. In the Channel selection window, individual parameters can be added or removed providing a customized view for each device if desired. See the following figure.

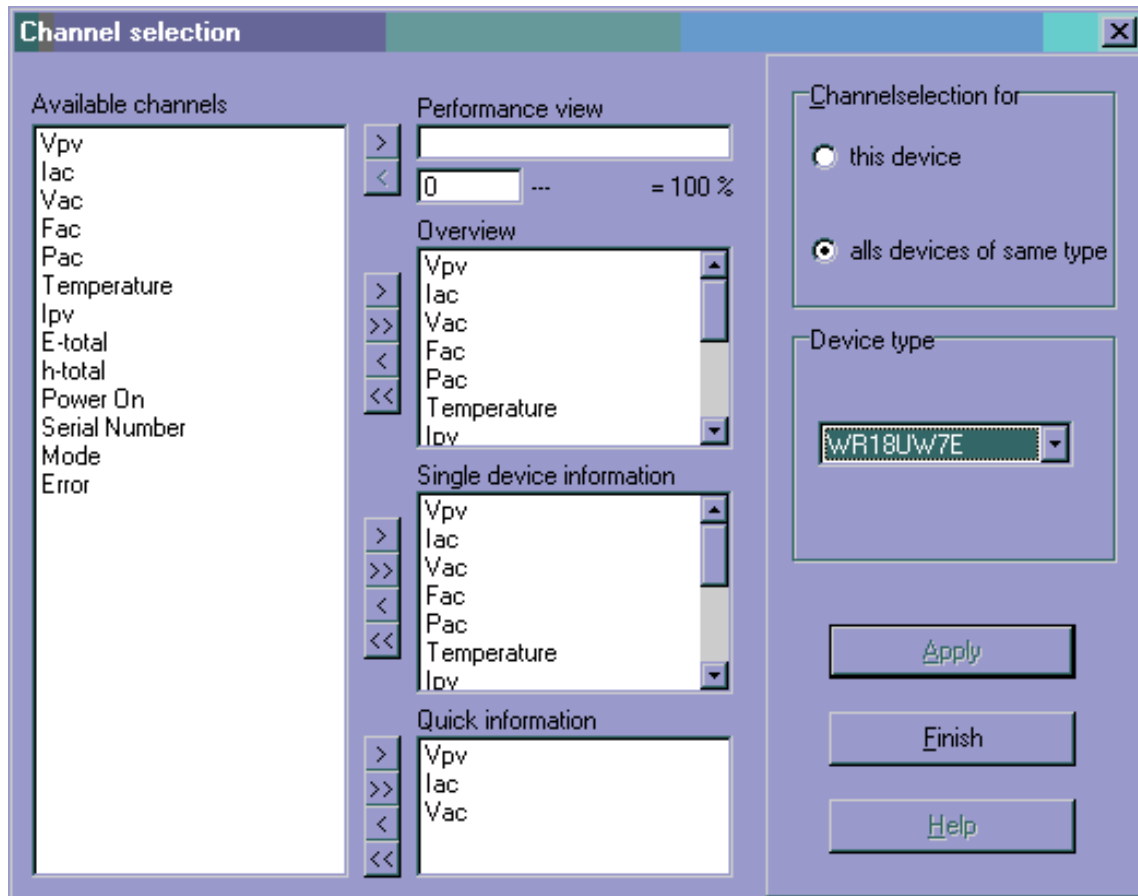

Figure 1-35 Channel Selection Window

For a complete listing of all of Sunny Data Control’s functions, click on the question mark near the top left of the SDC window and select Manual.

Troubleshooting

General Performance

Generally speaking, the majority of performance issues with the Sunny Beam will be communication related, e.g. too far from the Sunny Boy, interference from another appliance, etc. These issues can be easily overcome by experimenting with the placement and orientation of the Sunny Beam and its antenna.

Group Settings

In cases where a single Sunny Beam will monitor more than 4 inverters, or is multiple Sunny Beams will be used, it is necessary to assign each group of 4 inverters a Group Number. For example, inverters 1 through 4 would be Group 1, inverters 5 through 8 would be Group 2, and so forth. To select a Group Number on the piggy-back board, simply change the settings of the DIP switch to the desired group using the following table. On the Sunny Beam, Go to the Main Menu, Select Setup, then Plant, then Group. In the Group menu the desired group can be selected. As an added convenience, the Group menu in the Sunny Beam also includes an image of the proper DIP switch settings for that group.















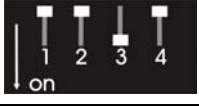

DIP switch	Group (decimal)		Group (decimal)
	0		8
	1 (default)		9
	2		10
	3		11
	4		12
	5		13
	6		14
	7		15

Figure 1-36 DIP Switch Settings

Sunny Beam Antenna Orientation

Better performance can sometimes be achieved by reorienting the antenna on the Sunny Beam. Because the antenna is strongest to the sides as opposed to the ends, it can improve performance to have the side of the antenna facing the direction of the Sunny Boy. For example, if the Sunny Boy was located directly above the Sunny Beam, (e.g. on the roof), or directly below the Sunny Beam, (e.g. in a garage or basement), it might improve performance to orient the antenna horizontally as shown in the figure below.

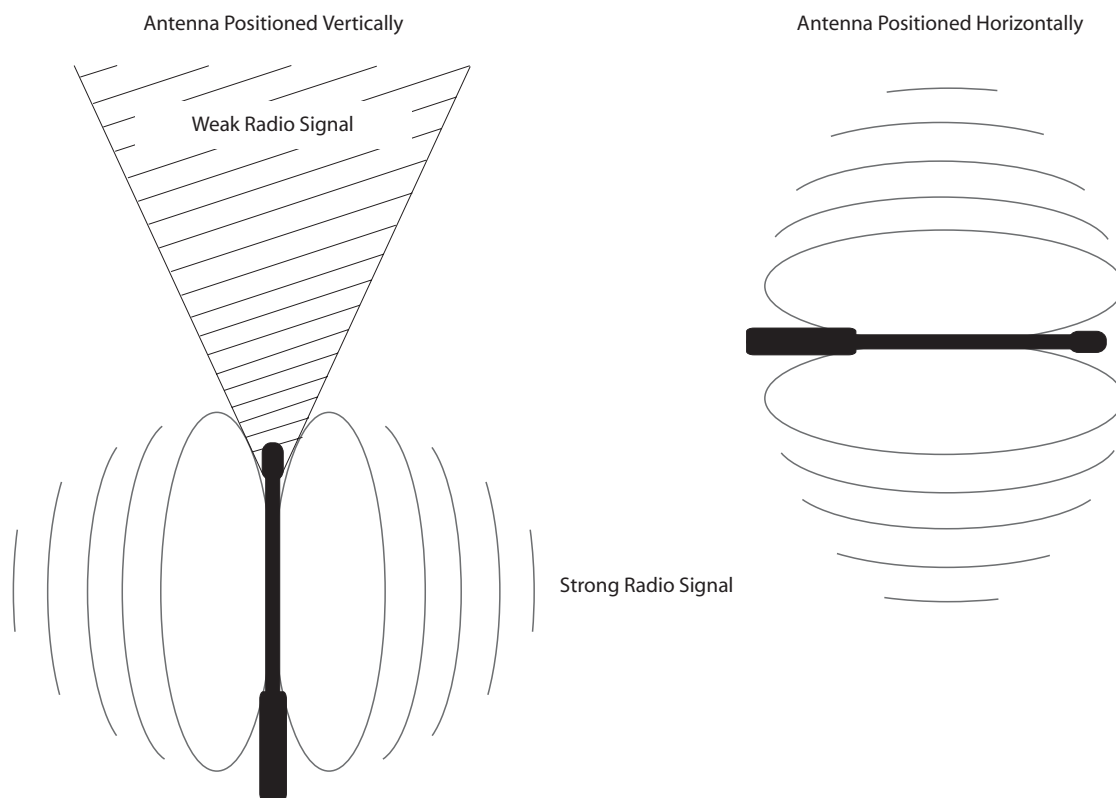

Figure 1-37 Sunny Beam Antenna Orientation

Sunny Boy Antenna Orientation

The same holds true for the Sunny Boy antenna. The antenna on the Sunny Boy can be reoriented through the use of an optional antenna bracket that can be wall mounted in any position. This bracket is available through your SMA supplier.

Inverter Detection

All Inverters are not Detected

If after running the detection routine, one or more of the inverters are not detected, try the following:

- Check that the Sunny Beam is set for the correct Group (channel)
- Check the DIP switch on the communication board in the Sunny Boy to make sure it is set for the correct Group (channel)
- Move the Sunny Beam so that it is closer to the Sunny Boys
- Make sure that the Sunny Beam is approximately 10 feet from the Sunny Boys while detecting.



NOTE: Though this may sound counterintuitive, it is possible for the Sunny Beam to have difficulty communicating if it is too close to the Sunny Boy antenna. This is caused by the overloading of the receivers in both units. To prevent this, try to keep the Sunny Beam and Sunny Boys at least 10 feet apart.

Specifications

Parameter	Value
Power Supply	Integrated solar cell, internal batteries, external power supply
Internal Batteries	(2) 1.5VDC Accucell AC 1800 Rechargeable Alkalines
Sunny Beam Operating Temperature	0° to 40°C
Sunny Beam Enclosure	Indoor use only
Sunny Beam Supply Voltage	3 VDC
Radio Piggy-Back Operating Temperature	-25° to 85°C
Radio Piggy Back Supply Voltage	5 VDC
Frequency	917 MHz
USB	1.1
Display	1 x 5 Fold alphanumeric 2 x 6 Fold alphanumeric
Control	Rotary push-button
Languages	English, Spanish, German
Dimensions	3.0H x 5.0W x 7.7D inches (75 x 127 x 195 mm)
Weight	12.3 oz. / 350 g. (with batteries)

SMA America. Inc.

www.sma-america.com

12438-C Loma Rica Drive
Grass Valley, CA 95945
USA
Phone +1 530 273 4895
Fax +1 530 274 7271
www.sma-america.com



Headquarters:
Hannoversche Str. 1-5
34266 Niestetal
Germany
Phone +49 561 9522 0
Fax +49 561 9522 100
www.SMA.de

