



PV Inverters

SUNNY BOY 1100 / 1200 / 1700

Installation Guide



Table of Contents

1	Notes on this Manual.	5
1.1	Area of Validity.	5
1.2	Target Group	5
1.3	Additional Information	5
1.4	Symbols Used	6
2	Security	7
2.1	Appropriate Usage	7
2.2	Safety Instructions	9
3	Unpacking.	10
3.1	Packing List	10
3.2	Identifying the Sunny Boy	10
4	Installing the Device.	11
4.1	Selecting the Mounting Location.	11
4.2	Mounting the Sunny Boy with a Wall Mounting Bracket	13
5	Electrical Connection	15
5.1	Overview of the Connection Area	15
5.1.1	Exterior View.	15
5.1.2	Interior View	16
5.2	Connecting the Sunny Boy to the public grid (AC).	17
5.3	Setting the Display Language	22
5.4	Communication.	22
5.5	Connecting the PV Generator (DC)	23
5.6	Setting the installation country	25
6	Commissioning the Sunny Boy	26
6.1	Display	27

6.2	Blink Codes.	29
7	Opening and Closing.	32
7.1	Opening the Sunny Boy	32
7.2	Closing the Sunny Boy	33
8	Maintenance and Cleaning.	35
8.1	Check the Electronic Solar Switch for wear	35
9	Troubleshooting	36
9.1	The red LED is continuously on	36
9.1.1	Checking the PV Generator for Ground Fault.	36
9.1.2	Checking the Function of the Varistors	38
10	Decommissioning	40
10.1	Removing the Sunny Boy	40
10.2	Packaging the Sunny Boy.	41
10.3	Storing the Sunny Boy.	41
10.4	Disposing of the Sunny Boy	41
11	Technical Data	42
12	Accessories	46
13	Contact	47

1 Notes on this Manual

This manual describes how to mount, install, commission and service the Sunny Boy 1100 (SB 1100), Sunny Boy 1200 (SB 1200) and Sunny Boy 1700 (SB 1700).

Store this manual where it can be accessed at all times.

1.1 Area of Validity

This manual applies to the following SMA inverters:

- Sunny Boy 1100 (discontinued model),
- Sunny Boy 1200 (available on request),
- Sunny Boy 1700.

1.2 Target Group

This manual is for qualified personnel. The tasks described in this manual may only be performed by qualified personnel.





1.3 Additional Information

You will find further information on special topics such as designing a line circuit breaker or the description of the operating parameters in the download area at www.SMA.de/en.

Refer to the user manual for detailed information on troubleshooting and operating the Sunny Boy.

1.4 Symbols Used

The following types of safety instructions and general information appear in this document as described below:

	DANGER!
DANGER indicates a hazardous situation which, if not avoided, will result in death or serious injury.	
	WARNING!
WARNING indicates a hazardous situation which, if not avoided, could result in death or serious injury.	
	CAUTION!
CAUTION indicates a hazardous situation which, if not avoided, could result in minor or moderate injury!	
	NOTICE!
NOTICE indicates a situation that can result in property damage if not avoided.	
	Information
Information provides tips that are valuable for the optimal installation and operation of your product.	

2 Security

2.1 Appropriate Usage

The Sunny Boy is a PV inverter, which converts the DC current of the PV generator to AC current and feeds it into the public grid.

Principle of a PV system with this Sunny Boy

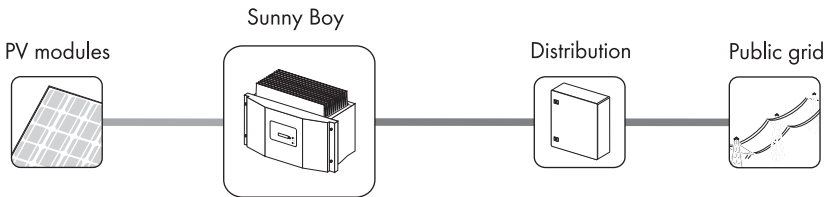

The Sunny Boy may only be operated with PV generators (modules and cabling) of protection class II. Do not connect any sources of energy other than PV modules to the Sunny Boy.

When designing the PV system, ensure that the values comply with the permitted operating range of all components at all times. The free design program "Sunny Design" (www.SMA.de/en/SunnyDesign) will assist you. The manufacturer of the PV modules must have approved the modules for use with this Sunny Boy. You must also ensure that all measures recommended by the module manufacturer for long-term maintenance of the module properties are taken (see also Technical Information "Module Technology", in the download area of www.SMA.de/en).

Do not use the Sunny Boy for purposes other than those described here. Alternative uses, modifications to the Sunny Boy or the installation of components not expressly recommended or sold by the manufacturer void the warranty claims and operation permission.

Certified Countries

The Sunny Boy 1100 / 1200 / 1700 (with according configuration) fulfill the requirements specified in the following standards and directives (dated: July/2009):

- VDE 0126-1-1 (02.2006)
- G83/1 (09.2003)
- CER/06/190 (10.2006)
- E 2750 (11.2004)
- PPC (06.2006)
- EN 50438 (12.2007)
- C10/C11 (08.2003)
- AS4777 (2005)
- MEA
- IEC-utility Meeting 216

SMA Solar Technology can preset special grid parameters for other countries / installation locations according to customer request, after evaluation by SMA Solar Technology.

You can later make modifications yourself by changing software parameters with respective communication products (e.g. Sunny Data Control). A personal password is required for this, which you can obtain from the Serviceline upon request.

2.2 Safety Instructions



DANGER!

Danger to life due to high voltages in the Sunny Boy!

- All work on the Sunny Boy must only be carried out by qualified personnel.
- The appliance is not to be used by children or persons with reduced physical, sensory or mental capabilities, or lack of experience and knowledge, unless they have been given supervision or instruction.
- Children should be supervised to ensure that they do not play with the appliance.



CAUTION!

Parts of the enclosure can get hot - Risk of burn injuries!

- Do not touch the enclosure of the Sunny Boy during operation.



NOTICE!

Foreign objects or water entering the Sunny Boy can damage the device!

Once the Electronic Solar Switch has been pulled out, the Sunny Boy only provides protection rating IP21. The Sunny Boy is then no longer protected against water and contamination with dirt!

In order that the protection rating IP65 is also provided during a temporary decommissioning, proceed as follows:

- Unplug all DC plug connectors and seal them with the protecting caps provided.
- Attach the Electronic Solar Switch again.



Grounding the PV generator

Comply with the local requirements for grounding the modules and the PV generator. SMA Solar Technology recommends to electrically bond the module frames, the racks and all metal surfaces and ground these in order to have optimal protection of the system and personnel.

3 Unpacking

3.1 Packing List

Check the delivery for completeness and for visible external damage, such as cracks in the enclosure or in the display. Please contact your dealer if something is damaged or missing.

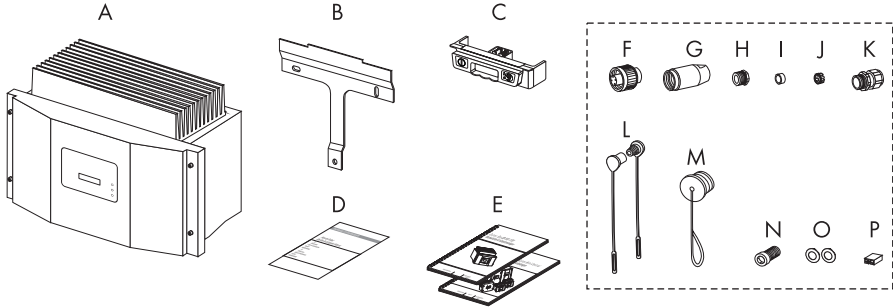

Object	Quantity	Description
A	1	Sunny Boy
B	1	Wall mounting bracket
C	1	Electronic Solar Switch (ESS)
D	1	Set of documents
E	2	1 installation guide, 1 user manual
F	1	Socket element
G	1	Threaded sleeve
H	1	Pressure screw PG13.5
I	1	Sealing ring PG13.5
J	1	Fastening case PG13.5
K	1	Cable gland PG16
L	2	Protecting caps for DC connector
M	1	Protective cap for AC screw clamp
N	1	M6x12 cylinder head screw
O	2	Plastic washer M5 (replacement for lid)
P	1	Jumper

3.2 Identifying the Sunny Boy

You can identify the Sunny Boy by the type plate. The type plate is on the right side of the enclosure. The serial number (serial No.) and the type (Type / Model) of the Sunny Boy are specified on the type plate.

4 Installing the Device

4.1 Selecting the Mounting Location



DANGER!

Danger to life due to fire or explosion!

Despite careful construction, a fire can occur with electrical devices.

- Do not mount the Sunny Boy on flammable construction materials.
- Do not mount the Sunny Boy near highly flammable materials.
- Do not mount the Sunny Boy in potentially explosive areas.



CAUTION!

Parts of the enclosure can get hot - Risk of burn injuries!

- Mount the Sunny Boy in such a way that it cannot be touched inadvertently during operation.



CAUTION!

Risk of injury due to the heavy weight of the Sunny Boy!

- Take the weight of the Sunny Boy of approx. 25 kg into account for mounting.

Observe the following conditions during mounting:

- The installation method and mounting location must be suitable for the weight and dimensions of the Sunny Boy (see section 11 "Technical Data" (page 42)).
- Mount on a solid surface.
- The installation location must be accessible at all times.



- Vertical installation or tilted backwards by max. 45°.
- The connection area must point downwards.
- Never install the device with a forward tilt.
- Do not install horizontally.
- Install at eye level to allow operating modes to be read.

- The ambient temperature should be below 40 °C to ensure optimal operation.
- The Sunny Boy must be easy to remove from the mounting location at any time.
- Do not expose the Sunny Boy to direct sunlight, so as to avoid power reduction due to excessive heating.
- In a living area, do not mount the unit on plasterboard walls (or similar) in order to avoid audible vibrations.

The Sunny Boy can make noises when in use which can be regarded as a nuisance when installed in a living area.

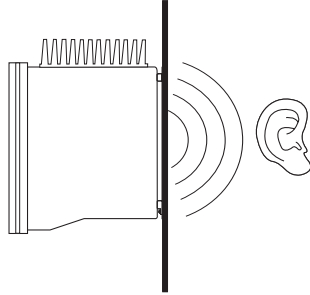

- Observe the minimum clearances to walls, other inverters or objects as shown in the diagram in order to guarantee sufficient heat dissipation and to have enough space for removing the Electronic Solar Switch.

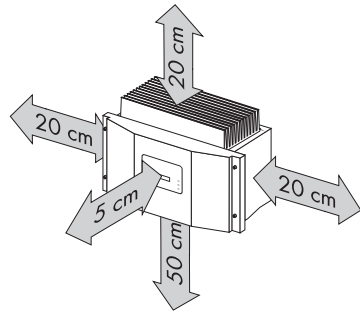

4.2 Mounting the Sunny Boy with a Wall Mounting Bracket



CAUTION!

Risk of injury due to the heavy weight of the Sunny Boy!

- Take the weight of the Sunny Boy of approx. 25 kg into account.
- When mounting the bracket, use fastening material suitable for the material.

1. Use the wall mounting bracket as a drilling template and mark the position of the drill holes.

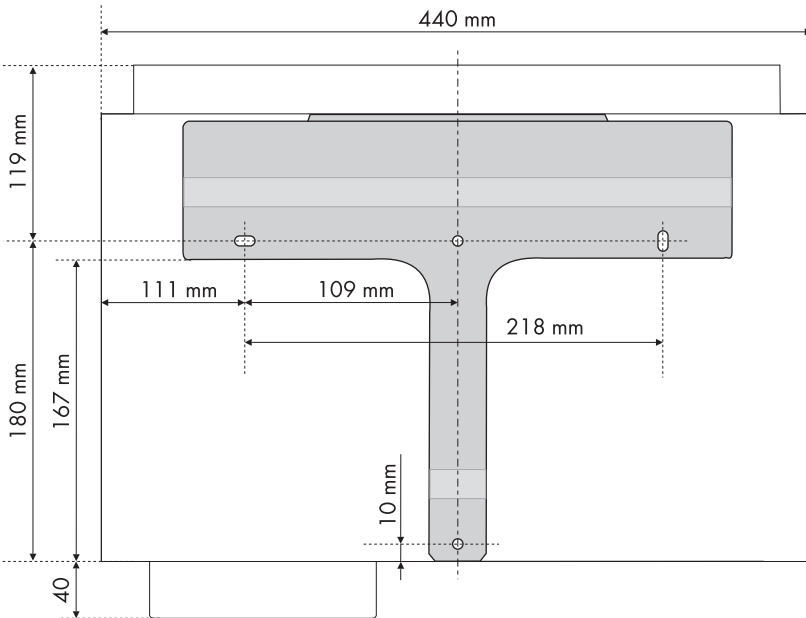

2. Attach the wall mounting bracket to the wall using appropriate screws and washers.

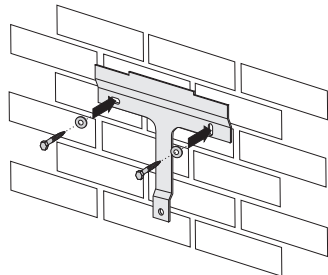

3. Use the upper mounting clips to fit the Sunny Boy in the wall mounting bracket so that it cannot be pushed out of the wall mounting bracket from the side.

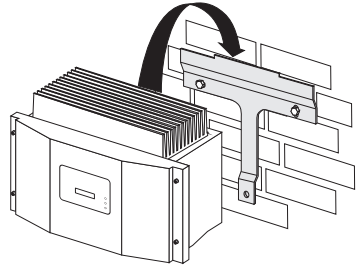

4. Secure the Sunny Boy in position fastening the supplied M6x12 screw.

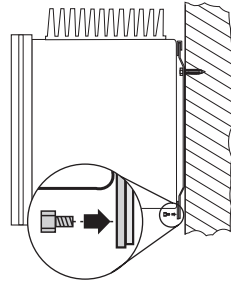

5. Check that the unit is securely in place.
- The Sunny Boy is now mounted on the wall.

5 Electrical Connection



NOTICE!

Electrostatic discharges can damage the Sunny Boy!

Internal components of the Sunny Boy can be irreparably damaged by static discharge.

- Ground yourself before touching a component.

5.1 Overview of the Connection Area

5.1.1 Exterior View

The following figure shows the assignment of the individual enclosure openings on the bottom of the Sunny Boy.

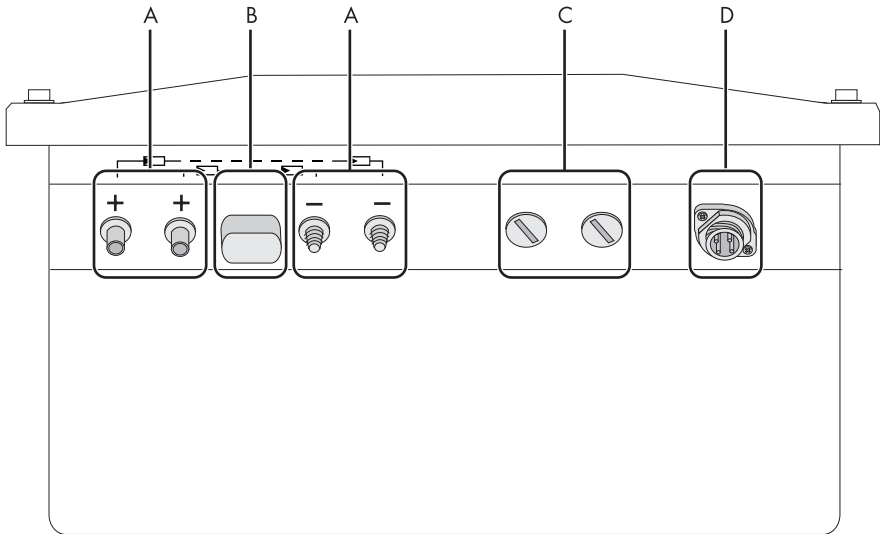

Object	Description
A	Plug connectors for connecting the PV strings
B	Socket for the connection of the Electronic Solar Switch (ESS) DC load disconnection unit
C	Cable feed-through for communication (with sealing plugs)
D	Plug for AC connection

5.1.2 Interior View

The following diagram gives a schematic overview of the various components and connection points inside the Sunny Boy with the lid removed:

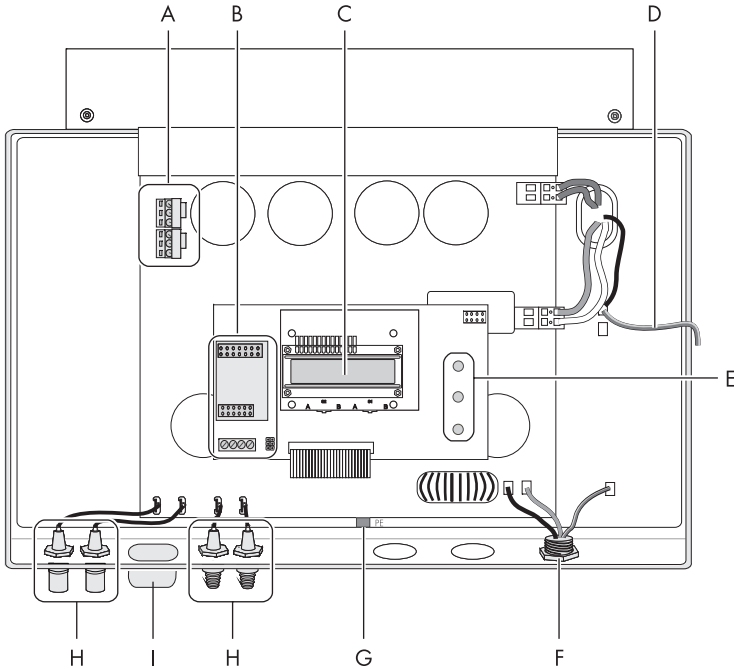

Object	Description
A	Varistors, section 9.1.2
B	Connection area and sockets for communication (RS485, radio), section 5.4
C	Display
D	PE (protective earth) connecting cable for cover
E	Operating status LEDs
F	Plug socket (AC), section 5.2
G	Tab for grounding the cable shield with RS485 communication
H	PV input plugs (DC), section 5.5
I	Electronic Solar Switch (ESS) socket

5.2 Connecting the Sunny Boy to the public grid (AC)



Connection requirements of the grid operator

Comply with the connection requirements of your utility operator.

Cable Design

The conductor cross-section should be dimensioned in a way that output losses do not exceed 1% at nominal power. Use "Sunny Design" (www.SMA.de/en/SunnyDesign) for this.

The maximum cable lengths relative to the conductor cross-section are shown in the following table.

Conductor cross-section	Maximum cable length		
	SB 1100	SB 1200	SB 1700
1.5 mm ²	21 m	18 m	15 m
2.5 mm ²	35 m	30 m	22.5 m

The conductor cross-section required in individual cases depends on the following factors:

- ambient temperature,
- routing method,
- UV resistance,
- line losses,
- valid installation guidelines of the respective country (of the installation site).

Cable Requirements

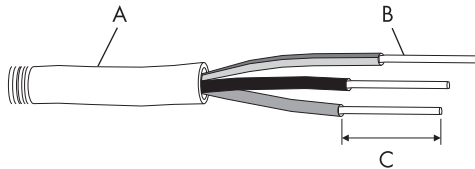

Position	Designation	Value
A	External diameter	9 ... 17 mm
B	Conductor cross-section	max. 2.5 mm ²
C	Strip insulation	4 ... 5 mm

Load Disconnection Unit

You must install a **separate** line circuit breaker for each inverter in order to ensure that the inverter can be securely disconnected under load. The maximal permissible rating is located in section 11 "Technical Data" (page 42)

Detailed information and examples for the design of a line circuit breaker can be found in the Technical Information "Line Circuit Breaker" in the download area of www.SMA.de/en.



DANGER!

Danger to life due to fire!

When more than one inverter is connected to the same line circuit breaker, the protective function of the line circuit breaker is no longer guaranteed. It can result in a cable fire or the destruction of the inverter.

- Never connect several inverters to a single line circuit breaker.
- Comply with the maximum permissible fuse protection of the inverter when selecting the line circuit breaker.



NOTICE!

Damaging of the Sunny Boy by using screw type fuse elements as load disconnection unit!

A screw type fuse element, e.g. D system (Diazed) or DO system (Neozed) is not a circuit breaker, and may **not** be used as a load disconnection unit. A screw type fuse element is only used as cable protection.

When disconnecting under load using a screw type fuse element, the Sunny Boy can be damaged.

- Use only a load disconnecting switch or a line circuit breaker as load disconnecting unit.



DANGER!

Danger to life due to fire!

When a generator (Sunny Boy) and a consumer are connected to the same line circuit breaker, the protective function of the line circuit breaker is no longer guaranteed. The current from the Sunny Boy and the grid can add up to overcurrent which is not detected by the line circuit breaker.

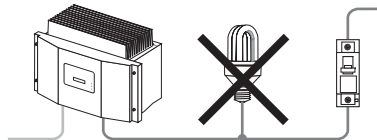

- Never connect loads between the Sunny Boy and the line circuit breaker without protection.
- Always install separate fuses for loads.

Overview AC connection socket

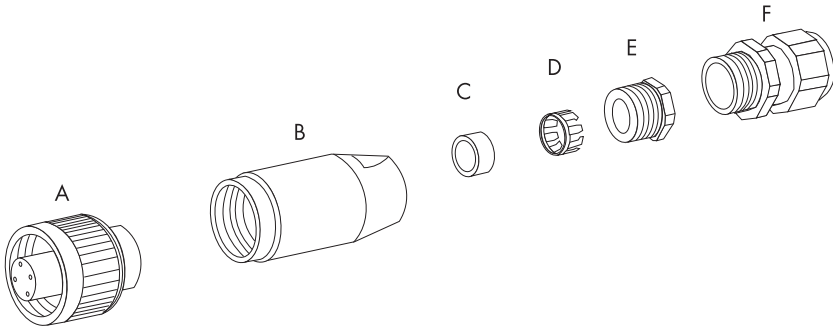

Object	Description
A	Socket element
B	Threaded sleeve
C	Sealing ring PG13.5
D	Fastening case PG13.5
E	Pressure screw for PG13.5 (for cable diameters between 9 and 13.5 mm)
F	Cable gland PG16 (for cable diameters between 13.5 and 17 mm)

Connection Procedure

1. Choose an appropriate screw fitting for the AC cable.
2. Check the grid voltage and compare it with "V_{AC}" on the type plate.
The exact working range of the Sunny Boy is specified in the operating parameters. These can be uploaded via a communication component or can be ordered from SMA Solar Technology.
3. Switch off the line circuit breaker and secure it to prevent it from being reactivated and ensure that no voltage is present.
4. Strip approx. 30 mm from the AC cable.
5. Shorten L and N by 5 mm.
6. Strip the wires of the cable by 4 to 5 mm.

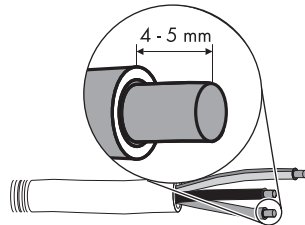
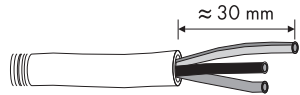

7. Lead the pressure screw and/or cable gland and socket tube via the AC cable.

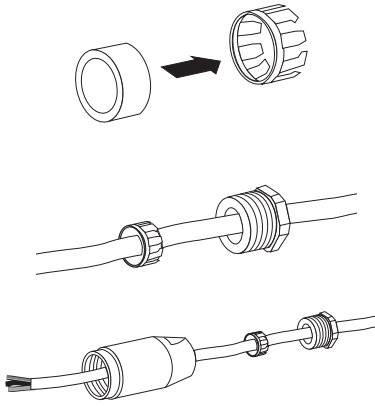
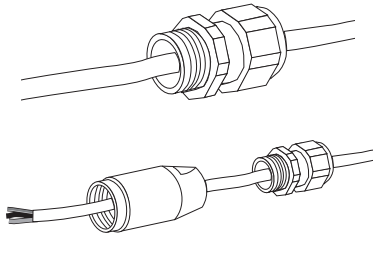
Size used	Procedure
PG13.5	<ul style="list-style-type: none"> • Push the sealing ring into the fastening case. • Lead the pressure screw PG13.5 and the fastening case including the sealing ring via the AC cable. • Lead the threaded sleeve via the AC cable. 
PG16	<ul style="list-style-type: none"> • Lead the cable gland PG16 via the AC cable. • Lead the threaded sleeve via the AC cable. 

8. Insert the protective earth PE (green-yellow) in the screw terminal with the earth sign on the socket element and tighten the screw.

9. Insert the neutral conductor N (blue) in the screw terminal 1 on the socket and tighten the screw.

10. Place phase L (brown or black) into screw terminal 2 on the socket insert and tighten the screw.

11. Terminal 3 on the socket element remains unused.

12. Make sure the wires are securely connected.

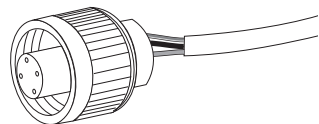
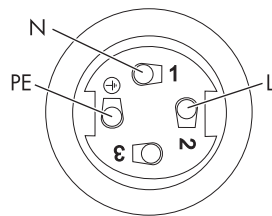

13. Screw the threaded sleeve onto the socket element.

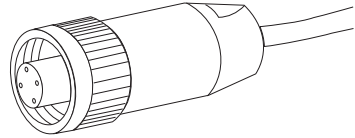

14. Screw the pressure screw tightly onto the threaded sleeve.

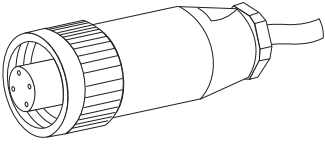
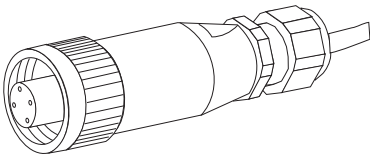
Size used	Procedure
<p>PG13.5</p>	 <p>The fastening case along with the sealing ring is pressed into the threaded sleeve and can no longer be seen.</p>
<p>PG16</p>	

AC connection socket has been screwed together.

15. Seal the socket element with the provided protecting cap if the Sunny Boy is not immediately connected.
16. Insert the AC connection socket into the AC socket on the Sunny Boy. If necessary, remove the protective cap beforehand.
17. Screw the AC connection socket's threaded ring tightly onto the AC socket on the Sunny Boy. The threaded ring acts as a seal and a cable grip for the AC connection socket.

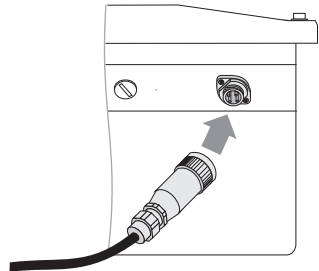

The AC cable is connected to the Sunny Boy.

⚠ DANGER!
Danger to life due to high voltages in the Sunny Boy!

- Do not switch on the line circuit breaker until the Sunny Boy is securely closed and the PV generator has been connected.

5.3 Setting the Display Language

You can set the language of the display using the switches on the underside of the display assemblies inside the Sunny Boy.

Proceed as follows to do so:

1. Open the Sunny Boy as described in section 7.1 "Opening the Sunny Boy" (page 32).
2. Set the switches to the desired language as illustrated below.

Language	Switch S2	Switch S1
German	B	B
English	B	A
French	A	B
Spanish	A	A

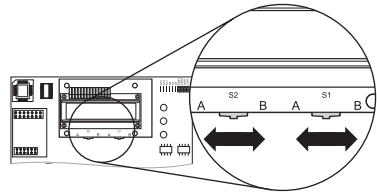

3. Close the Sunny Boy as described in section 7.2 "Closing the Sunny Boy" (page 33).

5.4 Communication

The Sunny Boy can be equipped with a communication interface (slot see section 5.1.2 "Interior View" (page 16)) in order to communicate with special data acquisition devices (e. g. Sunny WebBox) or a PC with appropriate software (e.g. Sunny Data Control).

See the communication interface manual for a detailed wiring diagram and a description of the mounting.

5.5 Connecting the PV Generator (DC)



Use of Adaptors

Adaptors (branch connectors) are not to be visible or freely accessible in the immediate surrounding of the Sunny Boy.

- The DC current flow may not be interrupted via adaptors.
- Always disconnect the current flow first via the Electronic Solar Switch.
- Requirements for the modules of the connected strings:
 - same type
 - same number
 - identical alignment
 - identical tilt
- The connecting wires of the PV modules must be equipped with plug connectors in order that these DC plug connectors can be connected to the DC input sockets of the Sunny Boy.
 A pre-assembled set for connecting the free cable ends of a string is available as optional accessory from SMA Solar Technology (see section 12 "Accessories" (page 46)).
- The following limit values at the DC input of the Sunny Boy may not be exceeded:

Sunny Boy	Maximum input voltage	Maximum input current
SB 1100	400 V (DC)	10 A (DC)
SB 1200	400 V (DC)	12.6 A (DC)
SB 1700	400 V (DC)	12.6 A (DC)



DANGER!

Risk of lethal electric shock or fire!

The maximum possible input current per string is limited by the plug connectors used. If the plug connector is overloaded, an electric arc may occur and there is a fire risk.

- Ensure that the input current for each string does not exceed the maximum flow current of the plug connectors used.

Connection Procedure



DANGER!

Danger to life due to high voltages in the Sunny Boy!

- Before connecting the PV generator, ensure that the line circuit breaker is switched off.

1. Pull the Electronic Solar Switch downwards, slightly towards the wall.

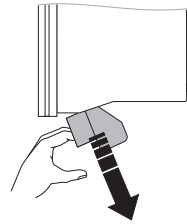

2. Check the connection cables of the PV modules for correct polarity and compliance with the Sunny Boy's maximum input voltage of 400 V (DC).

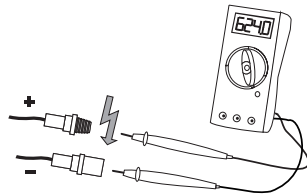

NOTICE!

Exceeding the maximum input voltage can destroy the Sunny Boy!

If the voltage of the PV modules exceeds the maximum input voltage of the Sunny Boy, it can be destroyed by the overvoltage. All warranty claims become void.

- Do not connect strings to the Sunny Boy with open circuit voltage greater than the maximum input voltage of the Sunny Boy.
- Check the system design.

3. Check the strings for ground faults, as described in section 9.1.1 "Checking the PV Generator for Ground Fault" (page 36).



DANGER!

Risk of lethal electric shock!

- Do not connect strings with ground faults.
- Firstly, clear the ground fault in the respective string.

4. Connect faultless strings of the PV generator.
5. Close unused DC input sockets with the protective caps provided.
6. Check the Electronic Solar Switch for wear, as described in section 8.1 "Check the Electronic Solar Switch for wear" (page 35), and attach until it audibly locks into place.

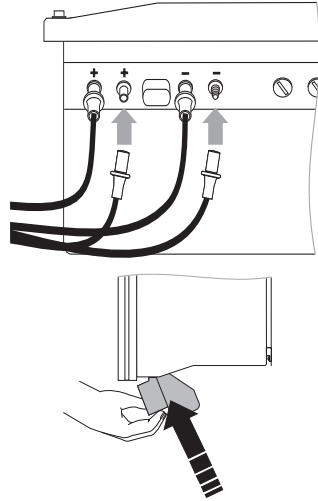
**NOTICE!****Manipulating the connector in the handle can damage the Electronic Solar Switch!**

The connector within the handle must remain movable in order to ensure proper contact. Tightening the screw voids all warranty claims and creates a fire risk.

- Do **not** tighten the connector screw in the Electronic Solar Switch handle.

**NOTICE!****The Electronic Solar Switch can be damaged if it is inserted incorrectly!**

The Electric Solar Switch can be damaged by high voltages if it has not been attached properly.

- Press the handle firmly into place on the socket of the Electronic Solar Switch until it audibly locks into place.
- Check that the handle is securely in place.

- The PV generator is now connected.

5.6 Setting the installation country

Using the "Default" parameter you can set the installation country and/or the grid connection standard valid for the country via a communication device (e.g. Sunny WebBox) or a PC with appropriate software (e.g. Sunny Data Control). However, this is only required if the Sunny Boy was originally ordered for another country. The standard to which the Sunny Boy was set upon delivery is specified on the type plate.

6 Commissioning the Sunny Boy

1. Check the following requirements before commissioning:
 - device is securely in place
 - correct connection of the AC cable (grid)
 - full connection of the DC cables (PV strings)
 - unused DC plug connectors on the underside of the enclosure are sealed with protecting caps
 - the enclosure lid is securely screwed in place
 - the Electronic Solar Switch (ESS) is securely plugged
 - the line circuit breaker is laid out correctly

2. Switch on the line circuit breaker.

The green LED is glowing or blinking if there is enough radiation: commissioning has been successful.

or:

The red or yellow LED is glowing or blinking: there has been an error. Proceed to step 3.

A	Green LED	In operation
B	Red LED	Ground fault or varistor defective
C	Yellow LED	Disturbance

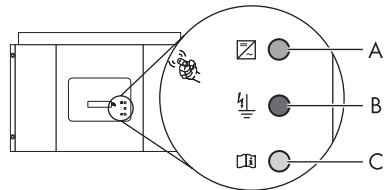

3. Read section 9 "Troubleshooting" (page 36) and, if necessary, the user manual provided. The meaning of the LED's as well as the error messages and status messages on the display are described in this section.

6.1 Display

Feeding Operation

After fault-free grid connection of the Sunny Boy, it takes approximately one minute until the following display messages are shown alternately. The display messages shown before only have the purpose of indicating the initialization of the Sunny Boy and the process of controlling whether the power supply requirements are fulfilled.

- Initially, the energy generated on the respective day and the current operating mode are displayed.
- After 5 seconds or by tapping on the enclosure lid, the current feed-in output and the input voltage appear.
- After a further 5 seconds, or when you tap again, the total energy produced and the time the Sunny Boy has been connected to the grid are displayed.
- Then the cycle is restarted.

```
E-today      0Wh
Mode         MPP
```

```
Pac          903W
Upv          260V
```

```
E-total      0kWh
h-total      0h
```

Disturbance

- If a disturbance occurs, the message "Disturbance" will be shown in the status bar.
- The exact failure message follows.
For example, if the grid disturbance message shown here is displayed immediately after connection, it may be due to the fact that the AC wire is not correctly connected or the line circuit breaker has not been switched on yet.
- If the disturbance was caused by a measured value that does not correspond to the standard, the value measured at the time of the disturbance is displayed. If another measurement is possible, the present value is displayed in the second line.

```
E-today      0Wh
Mode Disturbance
```

```
Disturbance
Vac-Bfr
```

```
at:          261W
Present:     245W
```

The precise meaning of the error and status messages are described in the Sunny Boy's user manual provided.

PV overvoltage

```
!PV-Overvoltage!  
!DISCONNECT DC!
```



NOTICE!

Excessive DC input voltage can destroy the Sunny Boy!

Immediately disconnect the Sunny Boy from the grid!

1. Turn off the line circuit breaker.
2. Remove the Electronic Solar Switch.
3. Disconnect the DC plug connectors.

1. Check DC voltage!

Result	Action
<input checked="" type="checkbox"/> The DC voltage is higher than the maximum input voltage.	<ul style="list-style-type: none"> • Contact the planner / installer of the PV generator.
<input checked="" type="checkbox"/> The DC voltage is lower than the maximum input voltage.	<ul style="list-style-type: none"> • Reconnect the Sunny Boy to the PV generator as described in section 5.5 "Connecting the PV Generator (DC)" (page 23).

2. If the message occurs again, disconnect the Sunny Boy again and contact the Serviceline of SMA Solar Technology (see section 13 "Contact" (page 47)).

6.2 Blink Codes

Overview

Green	Red	Yellow	Status
glows continuously	is not glowing	is not glowing	OK (feeding operation)
	glows continuously	is not glowing	Disturbance
		glows continuously	OK (initialization)
Flashes quickly (3 x per second)	is not glowing	is not glowing	OK (stop)
	glows continuously	is not glowing	Disturbance
Flashes slowly (1 x per second)	is not glowing	is not glowing	OK (waiting, grid monitoring)
	glows continuously	is not glowing	Disturbance
Briefly goes out (Approx. 1x per second)	is not glowing	is not glowing	OK (derating)
	glows continuously	is not glowing	Disturbance
is not glowing	is not glowing	is not glowing	OK (night shutdown)
		glows/flashes	Disturbance
	glows continuously	is not glowing	Disturbance
		glows/flashes	Disturbance

Feeding Operation

After a fault-free grid connection of the Sunny Boy, it takes approximately one minute until the green LED is continuously on. The blink codes shown before only have the purpose of indicating the initialization of the Sunny Boy and the process of controlling whether the power supply requirements are fulfilled.



Disturbance or Fault

If the Sunny Boy detects a disturbance or fault, this event is indicated through a blink code of the yellow and, where applicable, the red LEDs.

For example, if the yellow LED glows for 5 seconds immediately after connection, then goes out for 3 seconds and then flashes briefly twice, there is a grid fault. This can be due to the fact that either the AC cable has not been connected correctly or the line circuit breaker has not yet been switched on.

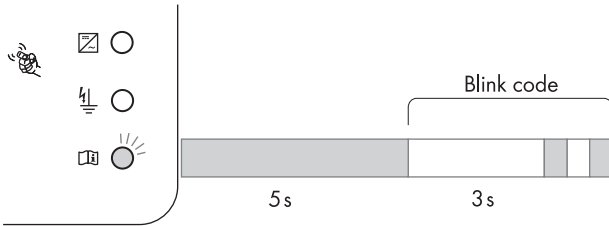

Explanation of the Blink Codes

For a detailed description of the blink codes, see the provided Sunny Boy user manual.

PV overvoltage

(Yellow LED flashes 4 times quickly in succession)

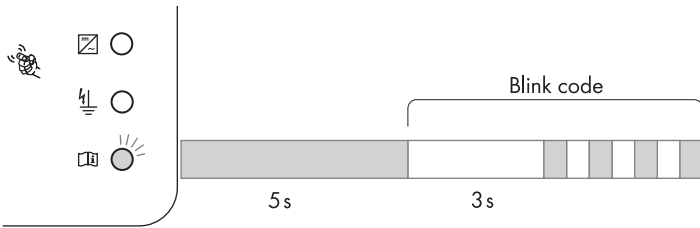

NOTICE!
Excessive DC input voltage can destroy the Sunny Boy!

Immediately disconnect the Sunny Boy from the grid!

1. Turn off the line circuit breaker.
2. Remove the Electronic Solar Switch.
3. Disconnect the DC plug connectors.

1. Check DC voltage!

Result	Action
<input checked="" type="checkbox"/> The DC voltage is higher than the maximum input voltage.	<ul style="list-style-type: none"> • Contact the planner / installer of the PV generator.
<input checked="" type="checkbox"/> The DC voltage is lower than the maximum input voltage.	<ul style="list-style-type: none"> • Reconnect the Sunny Boy to the PV generator as described in section 5.5 "Connecting the PV Generator (DC)" (page 23).

2. If the message occurs again, disconnect the Sunny Boy again and contact the Serviceline of SMA Solar Technology (see section 13 "Contact" (page 47)).

7 Opening and Closing



NOTICE!

Electrostatic discharges can damage the Sunny Boy!

Internal components of the Sunny Boy can be irreparably damaged by electrostatic discharge.

- Ground yourself before touching a component.

7.1 Opening the Sunny Boy



DANGER!

Danger to life due to high voltages in the Sunny Boy!

Before you open the Sunny Boy:

- Switch off the line circuit breaker and secure it to prevent it from being reactivated.

1. Pull the Electronic Solar Switch downwards, slightly towards the wall.

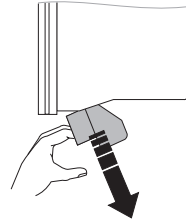

DANGER!

Danger to life due to unsafe disconnection from the PV generator!

Safe disconnection from the PV generator is only guaranteed after removal of the Electronic Solar Switch **and** of all DC plug connectors.

- Remove the DC plug connector immediately to completely disconnect the PV generator from the Sunny Boy.

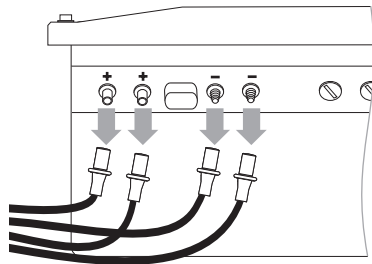

2. Disconnect the PV generator from the Sunny Boy.
3. Check whether all LEDs and the display have gone out.

**DANGER!**

Danger to life due to high voltages in the Sunny Boy!

The capacitors in the Sunny Boy require 15 minutes to discharge.

- Wait 15 minutes before opening the Sunny Boy.

4. Remove all screws from the enclosure lid and pull the lid forward smoothly.

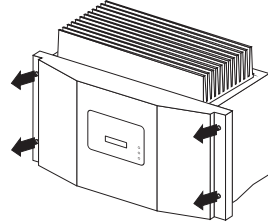

5. Remove the PE connection from the lid by loosening the locking device of the PE connection on the lid.
- The Sunny Boy is free of voltage and you can work on it.

7.2 Closing the Sunny Boy

1. Connect the protective earth (PE) to the enclosure lid.
2. Secure the enclosure lid of the Sunny Boy by evenly tightening the 4 lid screws.

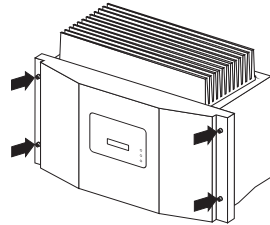

3. Check the DC plug connector for correct polarity and connect it.

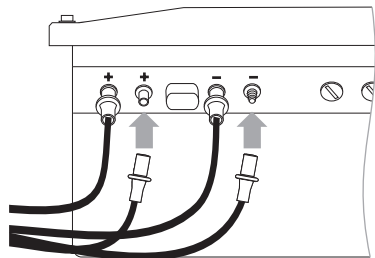

4. Check the Electronic Solar Switch for wear, as described in section 8.1 "Check the Electronic Solar Switch for wear" (page 35), and attach until it audibly locks into place.

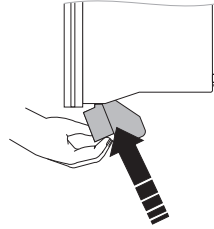

NOTICE!

Manipulating the connector in the handle can damage the Electronic Solar Switch!

The connector within the handle must remain movable in order to ensure proper contact. Tightening the screw voids all warranty claims and creates a fire risk.

- Do **not** tighten the connector screw in the Electronic Solar Switch handle.

NOTICE!

The Electronic Solar Switch can be damaged if it is inserted incorrectly!

The Electric Solar Switch can be damaged by high voltages if it has not been attached properly.

- Press the handle firmly into place on the socket of the Electronic Solar Switch until it audibly locks into place.
- Check that the handle is securely in place.

5. Switch on the line circuit breaker.
6. Check whether the Sunny Boy's display and LED display indicate normal operating mode (see section 6 "Commissioning the Sunny Boy" (page 26)).

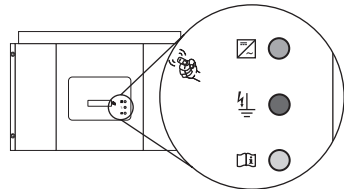

8 Maintenance and Cleaning

Check the correct operation of the Sunny Boy at regular intervals. Impurities such as dust or pollen can cause heat accumulation that can lead to yield losses. Also check the Sunny Boy and the cables for visible external damage. Undertake repairs if necessary.

8.1 Check the Electronic Solar Switch for wear

Check the Electronic Solar Switch for wear before plugging it in.

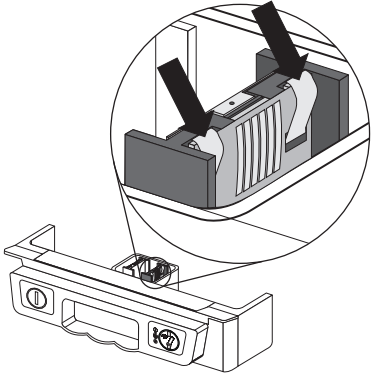
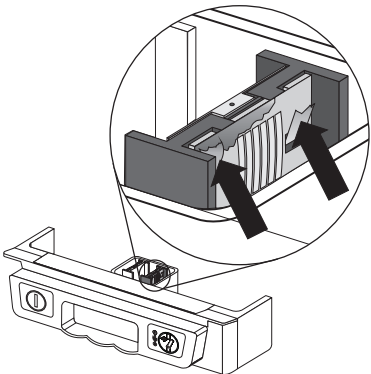
Result	Action
<p>☑ The metal tongues inside the connector have no damage and no discoloration.</p> 	<ol style="list-style-type: none"> 1. Attach the Electronic Solar Switch handle. 2. Commission the Sunny Boy.
<p>☑ The metal tongues inside the connector have a brown discoloration or are burned off.</p> 	<p>The Electronic Solar Switch can no longer reliably disconnect the DC side.</p> <ol style="list-style-type: none"> 1. Replace the Electronic Solar Switch handle before attaching it again (order number see section 12 "Accessories" (page 46). 2. Commission the Sunny Boy.

9 Troubleshooting

If the Sunny Boy displays other blink codes or display messages than those described in section 6 "Commissioning the Sunny Boy" (page 26), refer to the associated user manual in order to obtain the precise meaning of the display messages or the blink codes and, if necessary, the error correction.

Do not undertake any repairs that are not described here, but rather use the 24-hour replacement service (the Sunny Boy will be sent within 24 hours) and the repair service of SMA Solar Technology.

9.1 The red LED is continuously on

If the red LED of the status display is continuously on during operation, there is either a ground fault in the PV generator or at least one of the varistors for the overvoltage protection is defective.

9.1.1 Checking the PV Generator for Ground Fault

1. Disconnect the Sunny Boy from both the DC and AC connections, as described in section 7.1 "Opening the Sunny Boy" (page 32).



NOTICE!

Excessive voltages can destroy the measuring device!

- Only use measuring devices with a DC input voltage range up to at least 500 V.

2. Measure the voltages between the plus and minus pole of a string against the ground potential.

- If voltage is found, there is a ground fault in the corresponding string.

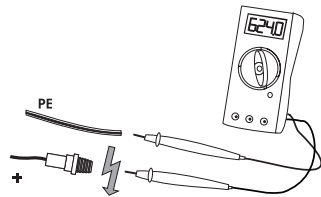

DANGER!

Risk of lethal electric shock!

In case of a ground fault, the PV generator may carry high voltages.

- Do not touch the frame of the PV generator.
- Wait until no voltage can be measured.
- Do not connect strings with ground faults to the Sunny Boy.

The approximate position of the ground fault can be determined from the ratio of the measured voltages between plus against ground potential and minus against ground potential.

Example:

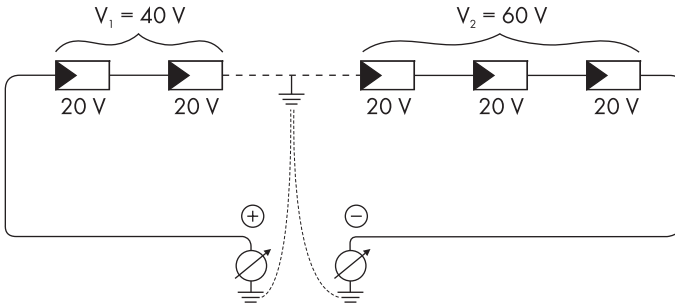

The ground fault is between the second and third module in this case.

3. Repeat step 2 for each string.

The table illustrated below shows the various results and corresponding measures.

Result	Action
<input checked="" type="checkbox"/> You have found a ground fault .	<ul style="list-style-type: none"> The installer of the PV generator must remedy the ground fault in the affected string before you may reconnect the string to the Sunny Boy. Do not reconnect the faulty string. Close and commission the Sunny Boy as described in section 7.2 "Closing the Sunny Boy" (page 33).
<input checked="" type="checkbox"/> You have found no ground fault .	It is likely that one of the thermally monitored varistors is defective. <ul style="list-style-type: none"> Check the varistors as described in section 9.1.2 "Checking the Function of the Varistors" (page 38).

The ground fault check is finished.

9.1.2 Checking the Function of the Varistors

Varistors are wearing parts. Their functioning becomes restricted through aging or due to repeated responses as a result of overvoltages. It is therefore possible that one of the thermally monitored varistors has lost its protective function, and thus the red LED is lit.



Position of varistors

You can determine the position of the varistors with the help of the illustration below.

Observe the following allocation of the terminals:

- Terminal A: outer terminal (varistor connection **with loop** [crimp])
- Terminal B: middle terminal
- Terminal C: outer terminal (varistor connection **without loop** [crimp])

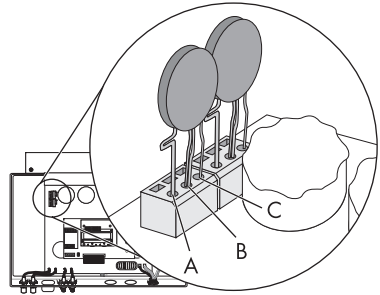

Check the function of the varistors as described below:

1. Open the Sunny Boy as described in section 7.1 "Opening the Sunny Boy" (page 32).
2. With the aid of a multimeter, determine for both varistors in the installed state whether a conductive connection exists between connectors B and C.

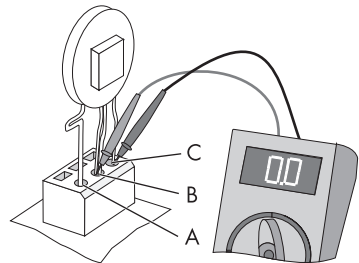

Result	Action
<input checked="" type="checkbox"/> There is a conducting connection.	There is probably another fault in the Sunny Boy. <ul style="list-style-type: none"> • Close the Sunny Boy as described in section 7.2 "Closing the Sunny Boy" (page 33). • Contact the SMA Serviceline (see section 13 "Contact" (page 47)).

Result	Action
<p><input checked="" type="checkbox"/> There is no conducting connection.</p>	<p>The respective varistor is not working and must be replaced.</p> <p>Varistor failure is generally due to influences which affect all varistors similarly (temperature, age, induced overvoltage). SMA Solar Technology recommends that you replace both varistors.</p> <p>The varistors are specially manufactured for use in the Sunny Boy and are not commercially available. They must be ordered directly from SMA Solar Technology (see section 12 "Accessories" (page 46)).</p> <ul style="list-style-type: none"> To replace the varistors, proceed to step 3.



NOTICE!

The Sunny Boy could be irreparably damaged by overvoltage!

If varistors are missing, the Sunny Boy is no longer protected against overvoltages.

- Replacement varistors should be obtained as soon as possible.
- Do **not** operate the Sunny Boy without varistors in systems with a high risk of overvoltages.

3. Insert an insertion tool into the openings of the terminal contacts (1).

The terminals will loosen.

If you do not receive an insertion tool for operating the terminal clamps with your replacement varistors, contact SMA Solar Technology. The terminal contacts can also be provisionally serviced by a screwdriver with a 3.5 mm blade width.

4. Remove the varistor (2).

5. Insert new varistor.

The pole with the small loop (crimp) must be fitted to terminal A (3) when remounting.

6. Close the Sunny Boy as described in section 7.2 "Closing the Sunny Boy" (page 33).

The check of the varistors is completed.

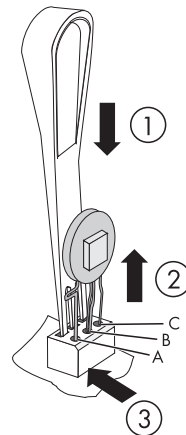

10 Decommissioning

10.1 Removing the Sunny Boy



CAUTION!

Risk of injury due to the heavy weight of the Sunny Boy!

- Take the weight of the Sunny Boy of approx. 25 kg into account.

1. Open the Sunny Boy as described in section 7.1 "Opening the Sunny Boy" (page 32).
2. Remove all cables from the Sunny Boy.
3. Close the Sunny Boy: fasten the enclosure lid to the Sunny Boy with the 4 screws.
4. Loosen the lower screw between the Sunny Boy and wall mounting bracket.

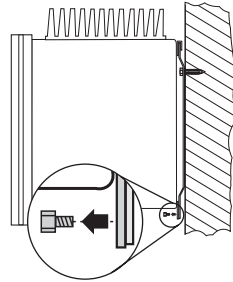

5. Remove the Sunny Boy from the wall mounting bracket.

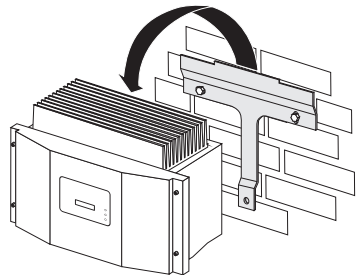

- The Sunny Boy has been removed.

10.2 Packaging the Sunny Boy

If possible, always package the Sunny Boy in the original packaging. If this is no longer available, you can also use an equivalent box. The box must be completely closeable and made to support both the weight and size of the Sunny Boy.

10.3 Storing the Sunny Boy

Store the Sunny Boy in a dry place where ambient temperatures are always between $-25\text{ }^{\circ}\text{C}$ and $+60\text{ }^{\circ}\text{C}$.

10.4 Disposing of the Sunny Boy

Dispose of the Sunny Boy at the end of its service life in accordance with the disposal regulations for electronic waste which apply at the installation site at that time. Alternatively, send it back to SMA Solar Technology with shipping paid by sender, and labeled "ZUR ENTSORGUNG" ("for disposal") (see section 13 "Contact" (page 47)).

11 Technical Data

PV generator connection data		SB 1100	SB 1200	SB 1700
Max. input voltage	$U_{DC Max}$	400 V ^{a)}		
Input voltage, MPP range	U_{PV}	139 V ... 320 V	100 V ... 320 V	139 V ... 320 V
PV start voltage, adjustable	$U_{PV Start}$	180 V	120 V	180 V
Max. input current	$I_{PV Max}$	10 A	12.6 A	12.6 A
Max. input power	P_{DC}	1210 W	1320 W	1850 W
Voltage ripple	U_{pp}	< 10 % of the input voltage		
Internal consumption during operation		< 4 W (standby)	< 4 W (standby)	< 5 W (standby)
a) The maximum open circuit voltage, which can occur at a cell temperature of 10 °C, may not exceed the maximum input voltage.				

Grid connection data		SB 1100	SB 1200	SB 1700
Nominal output power	$P_{AC nom}$	1000 W	1200 W	1550 W
Peak output power	$P_{AC max}$	1100 W	1200 W	1700 W
Nominal output current	$I_{AC nom}$	4.4 A	5.2 A	6.7 A
Max. output current	$I_{AC max}$	5.6 A	6.1 A	8.6 A
Max. fuse protection		16 A		
Harmonic distortion of output current (at $K_{Ugrid} < 2\%$, $P_{AC} > 0.5 P_{ACnom}$)	K_{IAC}	< 3 %		
Short Circuit Proof		grid-side via current regulation		
Nominal operating voltage	$U_{AC nom}$	220 V / 230 V / 240 V		
Voltage range (extended operating range)	U_{AC}	180 V ... 260 V		
Nominal operating frequency	$f_{AC nom}$	50 Hz / 60 Hz		
Frequency range (extended operating range)	f_{AC}	50 Hz: 45.5 Hz ... 54.5 Hz 60 Hz: 55.5 Hz ... 64.5 Hz		
Power factor (at nominal output power)	$\cos \varphi$	1		
Overvoltage category		III		
Test voltage (DC)		1.7 kV (1 s routine testing / 5 s type testing)		
Test surge voltage		4 kV (serial interface: 6 kV)		
Internal consumption in night operation		0.1 W		

General data	SB1100	SB 1200	SB1700
EC Declaration of Conformity	You can download the EC Declaration of Conformity in the download area at www.SMA.de/en under Certificates.		
Dimensions (W x H x D)	440 mm x 339 mm x 214 mm (approx.)		
Weight	approx. 22 kg	approx. 23 kg	approx. 25 kg
Protection rating according to DIN EN 60529	IP65		
Climatic conditions according to DIN EN 50178:1998 - 04			
Location of type C:	Class 4K4H Extended temperature range: -25 °C ... +60 °C Extended humidity range: 0 ... 100 % Extended air pressure range: 79.5 kPa ... 106 kPa		
Transport of type E:	Class 2K3 Temperature range -25 °C ... +70 °C		
Operating temperature range	-25 °C ... +60 °C		
Max. operating altitude	2000 m above mean sea level		
Topology	Low frequency transformer		
Protection class	I		
Noise emission (typical)	≤ 39 dB(A)	≤ 41 dB(A)	≤ 46 dB(A)
Protective function DC side			
All-pole disconnection unit on the DC input side	Electronic Solar Switch, DC plug connector		
Overvoltage protection	Thermally monitored varistors		
Personal protection	Insulation monitoring (Riso > 1MΩ)		
Pole Confusion Protection	Via short-circuit diode		
Protective function AC side			
Short Circuit Proof	Current control		
All-pole disconnection unit grid side	Automatic disconnection device (SMA Grid Guard 2.1), double implementation		

Communication interfaces	SB 1100	SB 1200	SB 1700
RS485 (galvanically isolated)		optional	
Radio		optional	

Electronic Solar Switch (ESS)	
Electrical lifetime (in the event of a short circuit, with a nominal current of 30 A)	Min. 50 switching processes
Maximum switching current	30 A
Maximum switching voltage	800 V
Maximum PV power	approx. 10 kW
Protection rating when plugged	IP65
Protection rating when unplugged	IP21

Efficiency		SB1100	SB 1200	SB1700
Max. efficiency	η_{max}	93 %	92.1 %	93.5 %
European efficiency	η_{euro}	91.6 %	90.7 %	91.8 %

Efficiency curves

Sunny Boy 1200

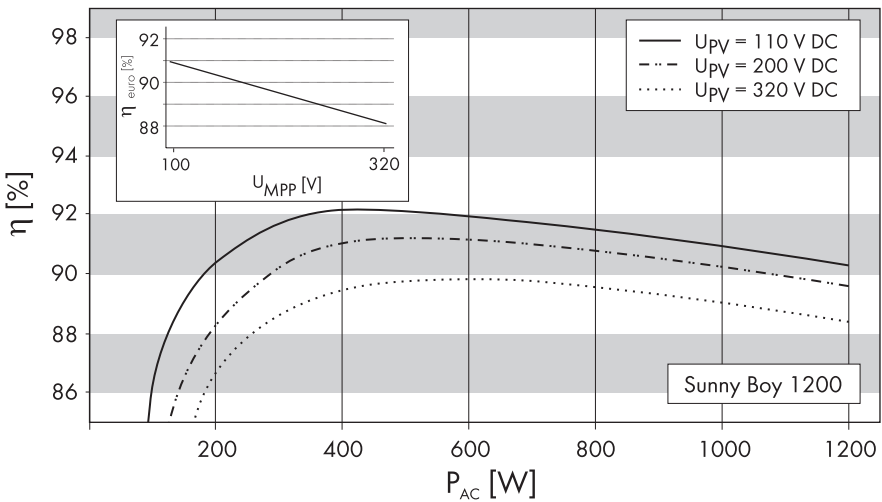

Sunny Boy 1700

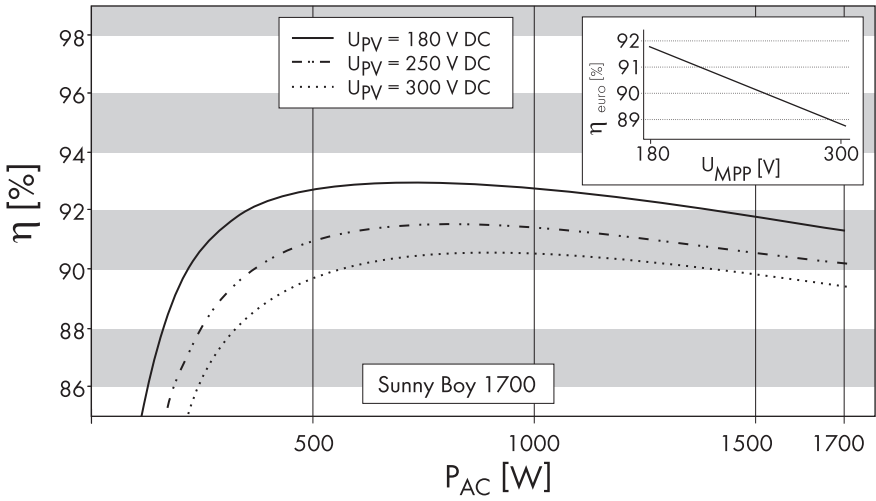

12 Accessories

In the following overview you will find the corresponding accessories and replacement parts for your product. If needed, you can order these from SMA Solar Technology or your dealer.

Designation	Brief description	SB 1100 / 1200 / 1700 SMA order number
DC connection set Multi-Contact 3 mm	Multi-contact 3 adapter set max. flow current: 21 A	SWR-MC
DC connection set Multi-Contact 4 mm	Multi-contact 4 adapter set max. flow current: 30 A	MC-SET
Tyco DC connection set	TYCO adapter set, max. flow current: 30 A	TYCO-SET
Electronic Solar Switch	ESS handle replacement part	ESS-HANDLE:01
Replacement varistors	Set of thermally monitored varistors (2 pcs.) including insertion tool SB-TVWZ	SB-TV3
Insertion tool for replacing the varistors	Insertion tool for varistor sets	SB-TVWZ
Positive grounding set	Upgrade kit for the positive connection to ground of the DC input	ESHV-P-NR
Negative grounding set	Upgrade kit for the negative connection to ground of the DC input	ESHV-N-NR
RS485 upgrade kit	RS485 interface	485PB-NR
Radio upgrade kit	Radio Piggy-Back for upgrading a Sunny Boy for communication with Sunny Beam, including antenna, coaxial cable, and PG cable gland (metal)	BEAMPB-NR
Bluetooth® Wireless Technology upgrade kit	Bluetooth interface	On request

13 Contact

If you have technical problems concerning our products, contact the SMA Serviceline. We require the following information in order to provide you with the necessary assistance:

- Inverter type
- Type and number of modules connected
- Communication type
- Serial number of the Sunny Boy
- Blink code or display of the Sunny Boy

SMA Solar Technology AG

Sonnenallee 1

34266 Niestetal, Germany

www.SMA.de

Serviceline

Inverters: +49 561 9522 1499

Communication: +49 561 9522 2499

Fax: +49 561 9522 4699

E-mail: Serviceline@SMA.de

The information contained in this document is the property of SMA Solar Technology AG. Publishing its content, either partially or in full, requires the written permission of SMA Solar Technology AG. Any internal company copying of the document for the purposes of evaluating the product or its correct implementation is allowed and does not require permission.

Exclusion of liability

The general terms and conditions of delivery of SMA Solar Technology AG shall apply.

The content of these documents is continually checked and amended, where necessary. However, discrepancies cannot be excluded. No guarantee is made for the completeness of these documents. The latest version is available online at www.SMA.de or from the usual sales channels.

Guarantee or liability claims for damages of any kind are excluded if they are caused by one or more of the following:

- Damages during transportation
- Improper or inappropriate use of the product
- Operating the product in an unintended environment
- Operating the product whilst ignoring relevant, statutory safety regulations in the deployment location
- Ignoring safety warnings and instructions contained in all documents relevant to the product
- Operating the product under incorrect safety or protection conditions
- Altering the product or supplied software without authority
- The product malfunctions due to operating attached or neighboring devices beyond statutory limit values
- In case of unforeseen calamity or force majeure

The use of supplied software produced by SMA Solar Technology AG is subject to the following conditions:

- SMA Solar Technology AG rejects any liability for direct or indirect damages arising from the use of software developed by SMA Solar Technology AG. This also applies to the provision or non-provision of support activities.
- Supplied software not developed by SMA Solar Technology AG is subject to the respective licensing and liability agreements of the manufacturer.

SMA Factory Warranty

The current guarantee conditions come enclosed with your device. These are also available online at www.SMA.de and can be downloaded or are available on paper from the usual sales channels if required.

Trademarks

All trademarks are recognized even if these are not marked separately. Missing designations do not mean that a product or brand is not a registered trademark.

The *Bluetooth*[®] word mark and logos are registered trademarks owned by Bluetooth SIG, Inc. and any use of such marks by SMA Solar Technology is under license.

SMA Solar Technology AG

Sonnenallee 1

34266 Niestetal

Germany

Tel. +49 561 9522-0

Fax +49 561 9522-100

www.SMA.de

E-Mail: info@SMA.de

© 2004 to 2009 SMA Solar Technology AG. All rights reserved

SMA Solar Technology AG

www.SMA.de

