

SELECTRONIC AUSTRALIA

Energy Management Mk II

Contents:	Page
ENERGY MANAGEMENT EMMKII	2
SETTINGS MENUS	3
SHUNT SETTINGS.....	13
BATTERY SETTINGS.....	16
SERIAL PORT SETTINGS.....	18
OTHER SETTINGS.....	20
INVERTER SETTINGS	23
READINGS	27
ADDITIONAL ELECTRICAL SPECIFICATIONS & INSTALLATION GUIDE	32
SINGLE SHUNT MEASUREMENT	37
MULTIPLE SHUNT MEASURING.....	37
REAR PANEL CONNECTIONS	42
INSTALLATION OF EMMKII OPTIONAL KEYPAD	44
INSTALLATION OF OPTIONAL CURRENT SHUNTS	47
MOUNTING TEMPLATE FOR EMMKII-KEY KEYPAD.....	52
SELECTRONIC AUTHORISED SERVICE NETWORK.....	53

ENERGY MANAGEMENT EMMKII

The EMMKII ENERGY MANAGEMENT option provides a wide range of monitoring and control features. These options can be tailored to best match your particular system requirements. Programming of these options can be done in one of three ways:

- i) The front keys on the Inverter**
- ii) A remote keypad - optional item**
- iii) Remote Link software - optional item**

Programming by the front keys on the Inverter

As there is a wide number of options; using the three keys on the front of the Inverter takes some time and patience to navigate through the menus. Do not despair as the effort will be well worth it.

***Front Panel Displays: The screens are divided into three types, Readings, Settings and Diagnostics.
The particular screens can be distinguished by the second line***

Readings	Settings	Diagnostics
Status: Standby Inverter: OFF	Set:OUTPUT 4 -Select Setting-	HS Temp: 34C ..Diagnostics..
No Hyphens	Hyphens used	Dots used

EMMK2 Installed

When the Energy Management Mark 2 is installed the Inverter will automatically sense this option and provide a much greater number of Readings and Settings options. Most of the additions occur in the Settings menu so these are described first.

Note that some of the Settings and Readings are dependant on whether the optional current shunt(s) are installed. Without current shunts the Inverter is unable to measure the percentage charge into and out of the batteries.

SETTINGS MENUS

Hold down the DISPLAY key for approx. two seconds while in a Readings screen

You will see one of the following displays:

Note the **Set:OUTPUT 1** display is the default, but whichever setting was last changed since power up will be displayed.

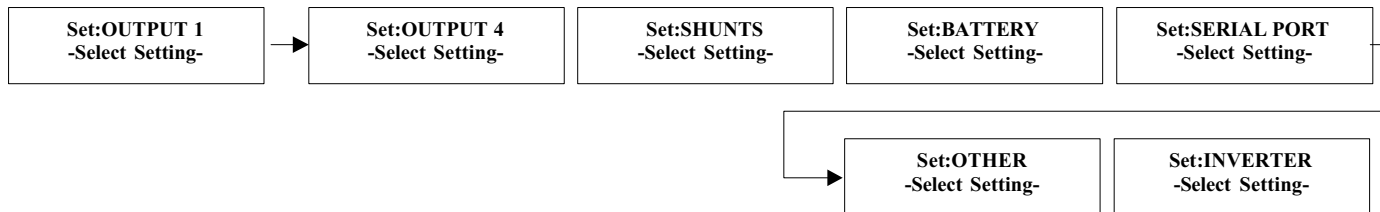

By pressing the Up or Down keys will move across the menus

By pressing the Display key you will move down the menus

OUTPUT

OUTPUTS 1 to 4 have the same settings with the exception that Outputs 3 and 4 do not have the Generator option.

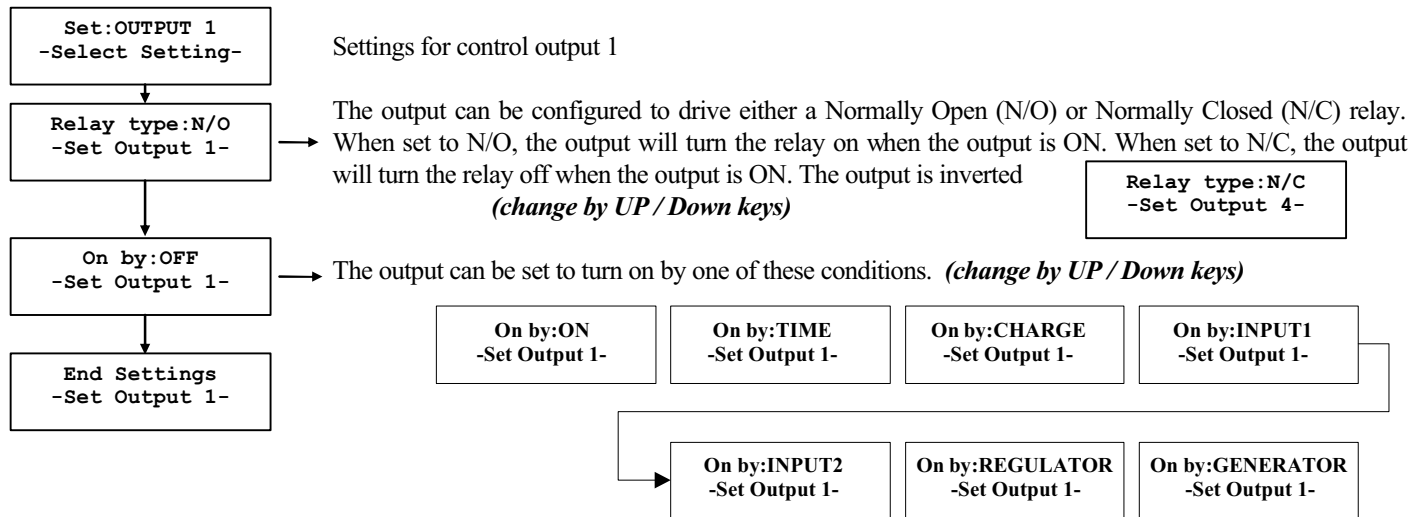

Explanation:

On by:OFF	Output stays Off
On by:ON	Output stays On continuously
On by:TIME	Output can be turned on at a specific time and day
On by:CHARGE	Output is switched on at low or high battery voltage or level of charge in the batteries
On by:INPUT	Output is switched on according to the voltage present on an input terminal
On by:REGULATOR	Output is switched on according to the regulator voltage settings
On by:GENERATOR	Output is switched on according to the generator control settings

On by:Time

Using this setting enables you to turn on the output at a specific time and day of the week.

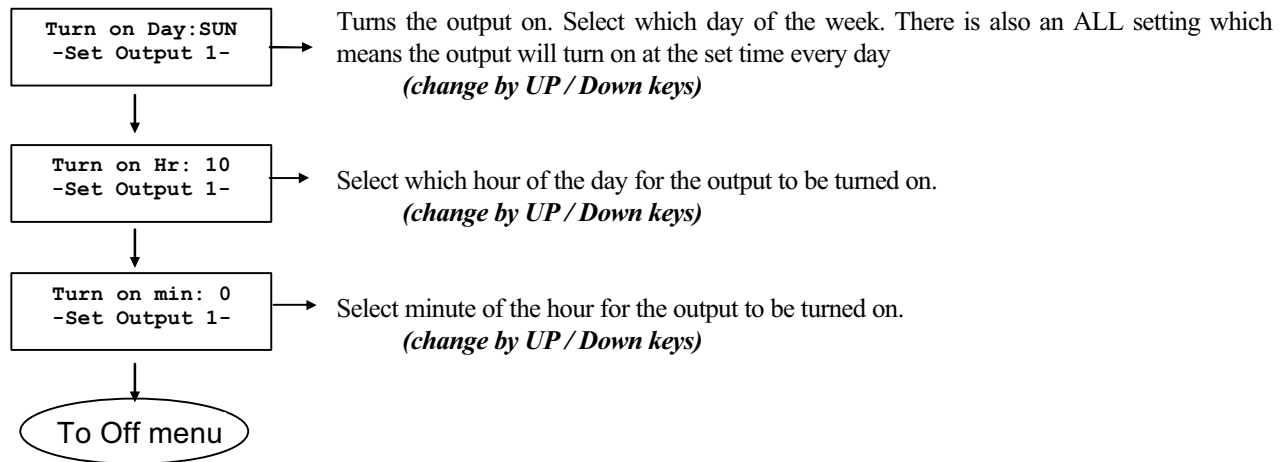

On by:CHARGE

Using this setting enables you to control the output according to the battery voltage or battery percentage charge.

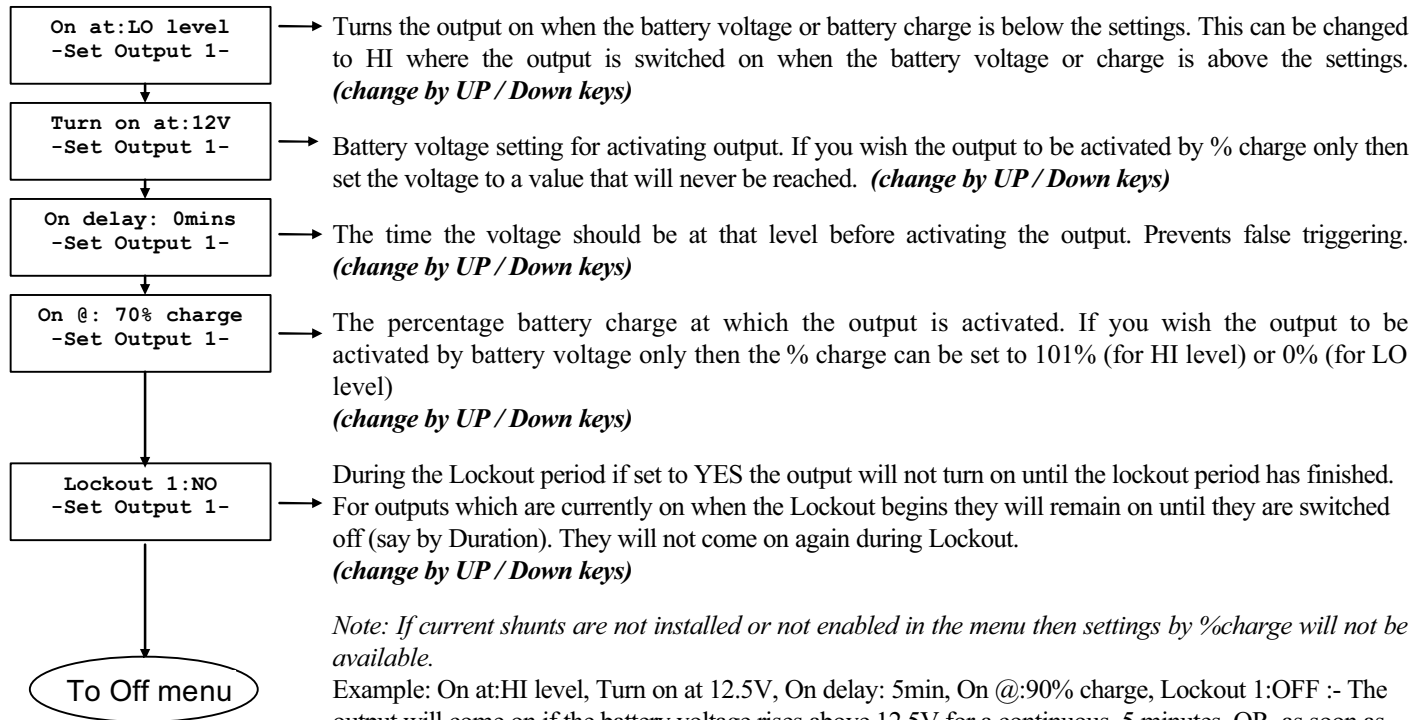

Note: If current shunts are not installed or not enabled in the menu then settings by %charge will not be available.

Example: On at:HI level, Turn on at 12.5V, On delay: 5min, On @:90% charge, Lockout 1:OFF :- The output will come on if the battery voltage rises above 12.5V for a continuous 5 minutes, OR as soon as the charge in the battery rises above 90%.

On by: INPUT1

Using this setting enables you to control the output according to voltage present on Input 1.

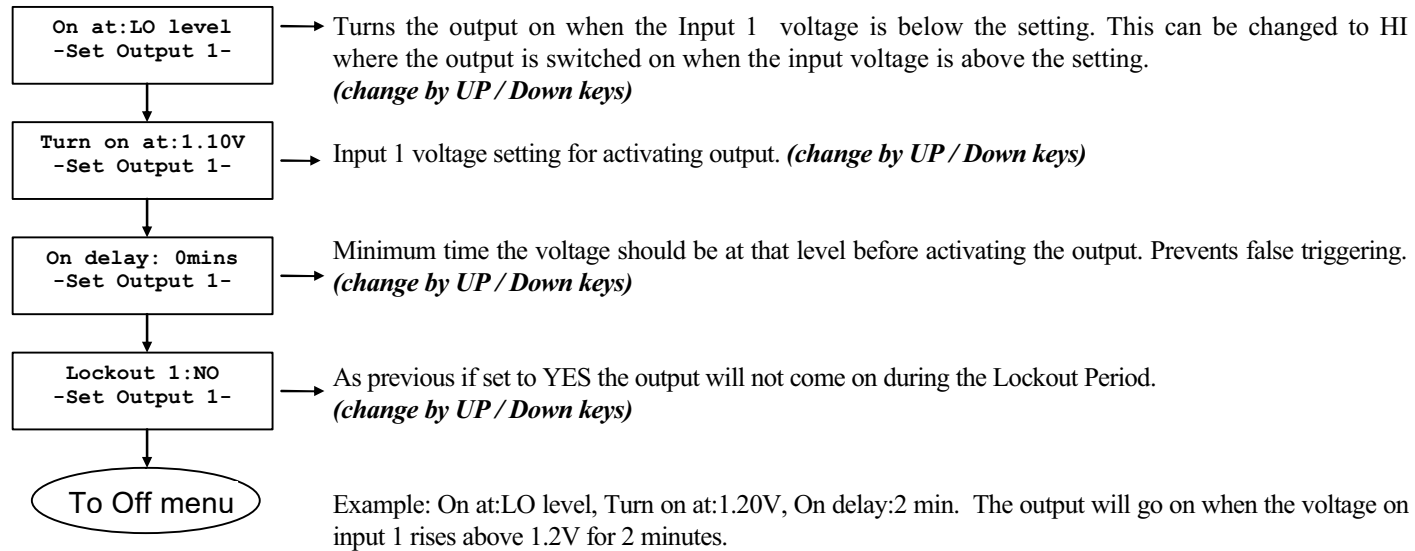

On by: INPUT 2

Same as Input 1 but the output is turned on by Input 2

On by:REGULATOR

Using this setting enables you to set the output to act as a regulator for solar, wind or hydro applications

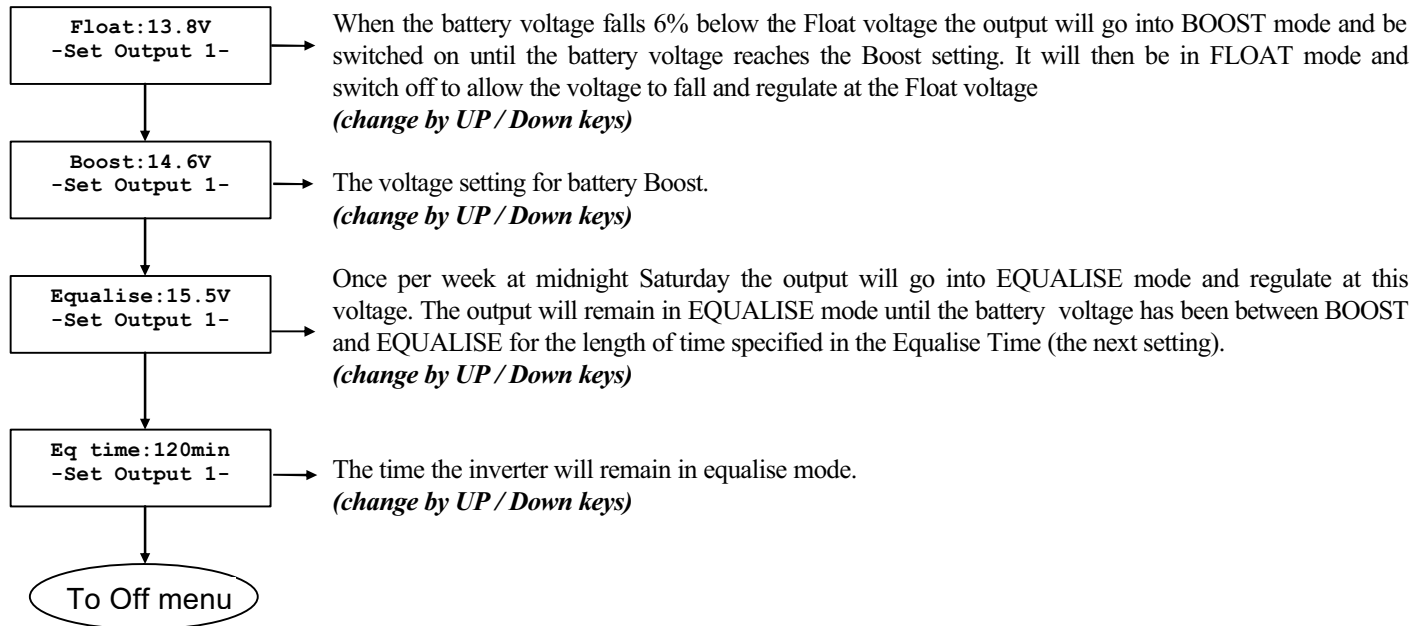

When the regulator feature is used and a current shunt is installed the following features are enabled.

- a. When FLOAT voltage is reached the AH (amp hours) is automatically reset to 100% to maintain accuracy.
- b. The battery efficiency is automatically check and updated. This means your battery efficiency setting will automatically track any changes in your battery due to battery aging, seasonal changes or system updates.

On by:GENERATOR (Output 1 only)

Available for Output 1 only. This enables the output 1 to control a generator by the battery voltage or % charge in battery. When output 2 is set to GENERATOR, it is configured to drive a change over relay which will switch the 240V from the inverter to the generator when the generator is running.

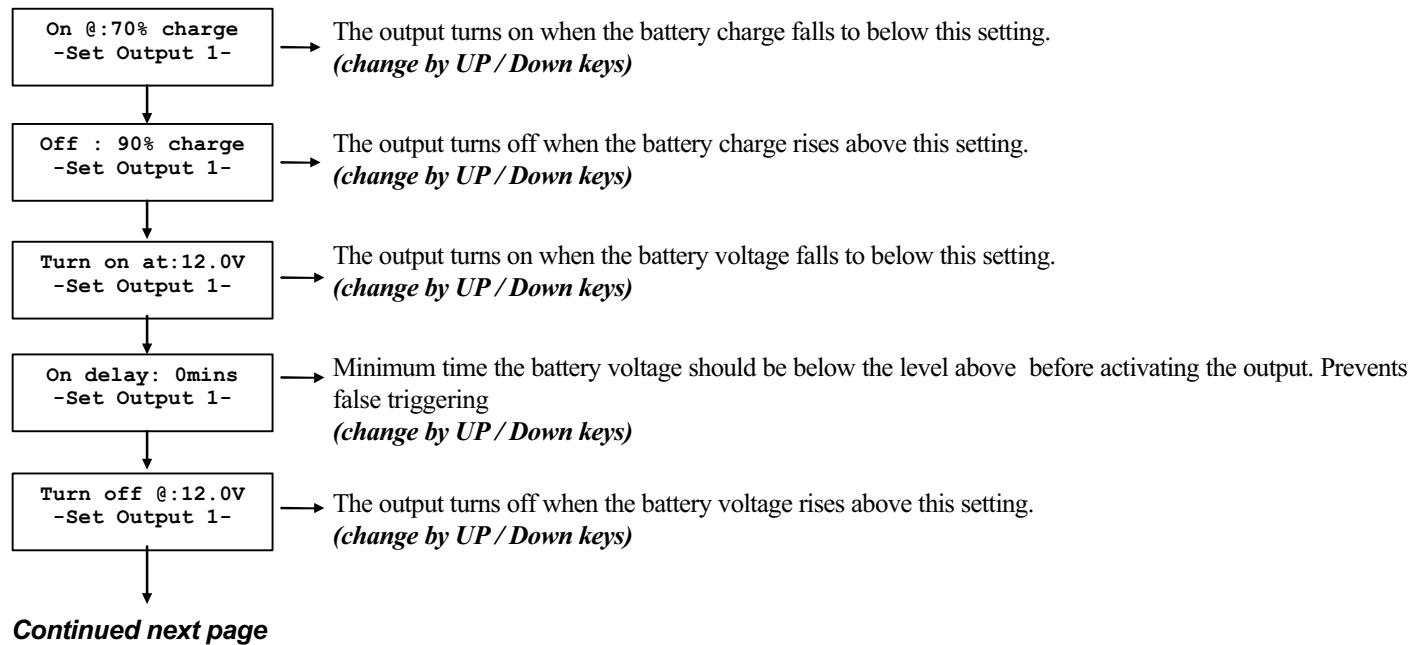

On by Generator Continued:

from previous page

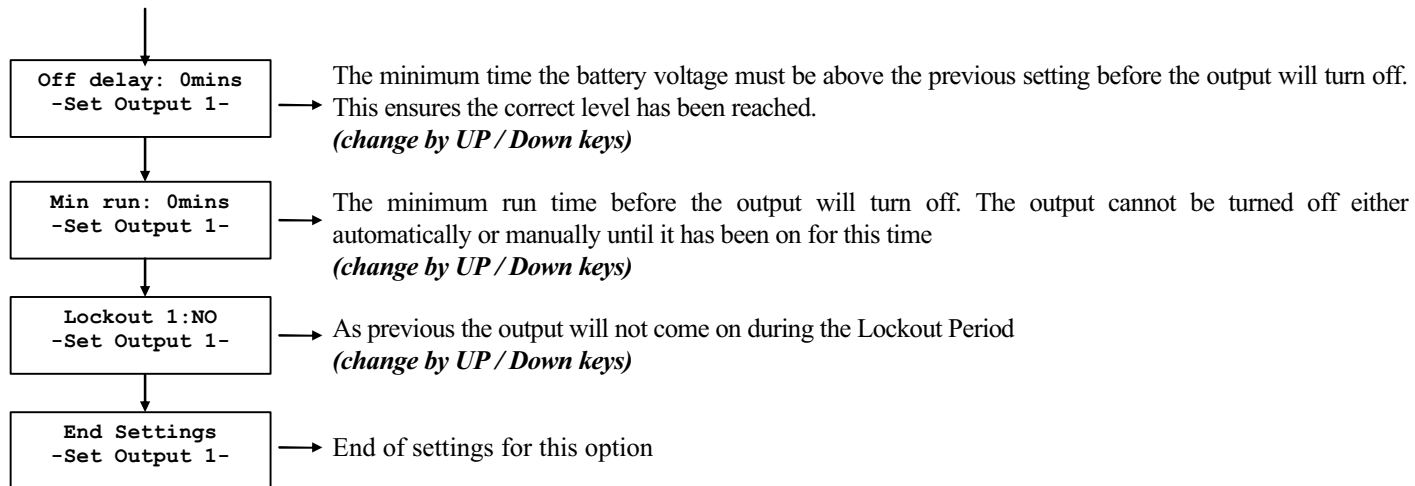

Note: If current shunts are not installed or not enabled in the menu then settings by %charge will not be available.

On by:GEN C/O (Output 2 only)

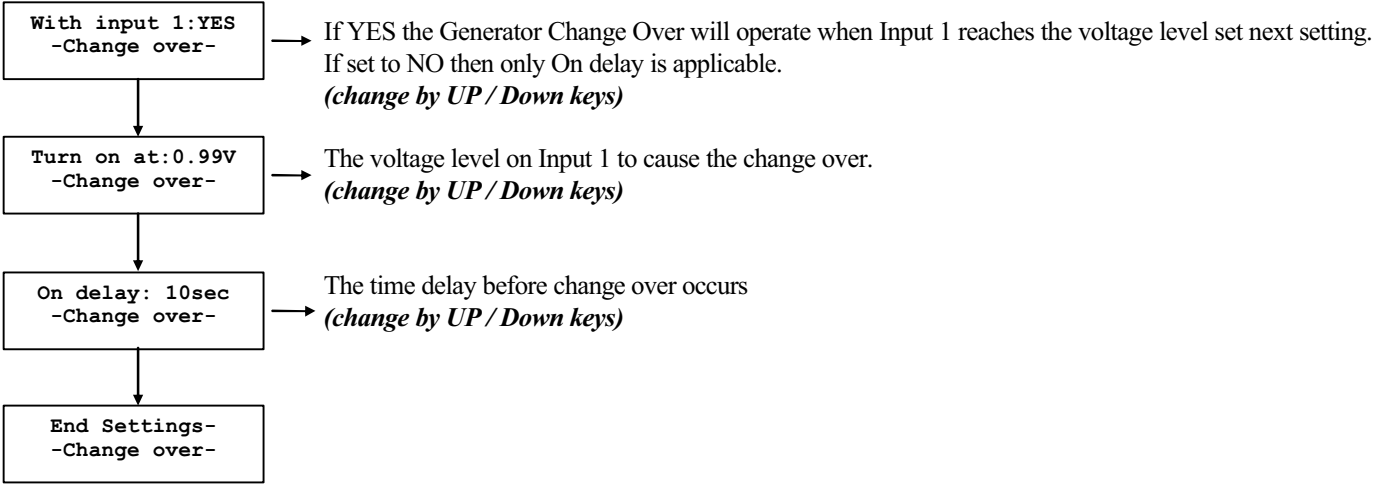

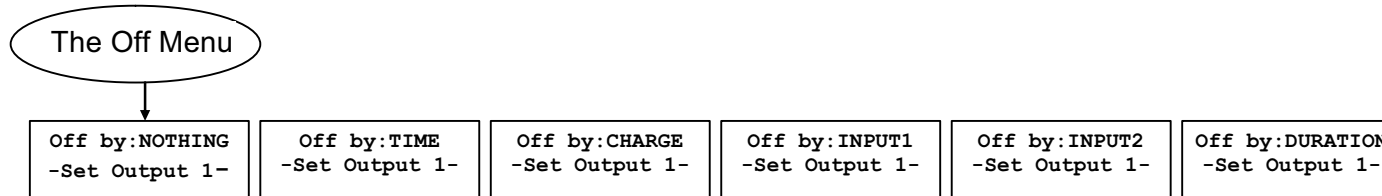

Explanation:

Off by:NOTHING	Output never turned off
Off by:TIME	Output turned off at a specific time and day
Off by:CHARGE	Output will switch off by high or low battery voltage or level of charge in the batteries
Off by:INPUT	Output is switched off according to the voltage present at an input terminal
Off by:DURATION	Output turned off after a set time in hours and minutes

The structure is similar to that for turning on the outputs.

SHUNT SETTINGS

Hold down the DISPLAY key for several seconds while in a Status screen

You will see one of the following displays:

Note the Set:OUTPUT 1 display is the default, but whichever setting was last changed will be displayed.

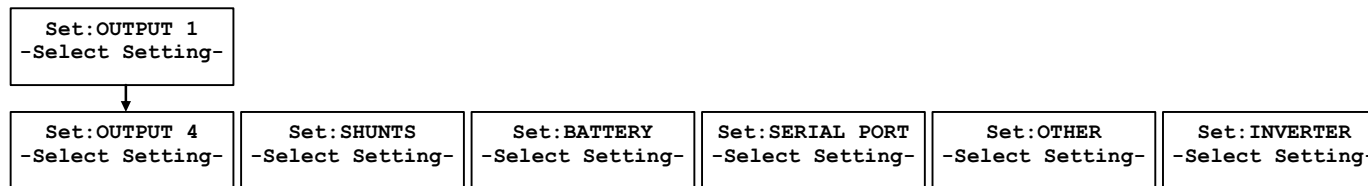

By pressing the Up or Down keys will move across the menus

By pressing the Display key you will move down the menus

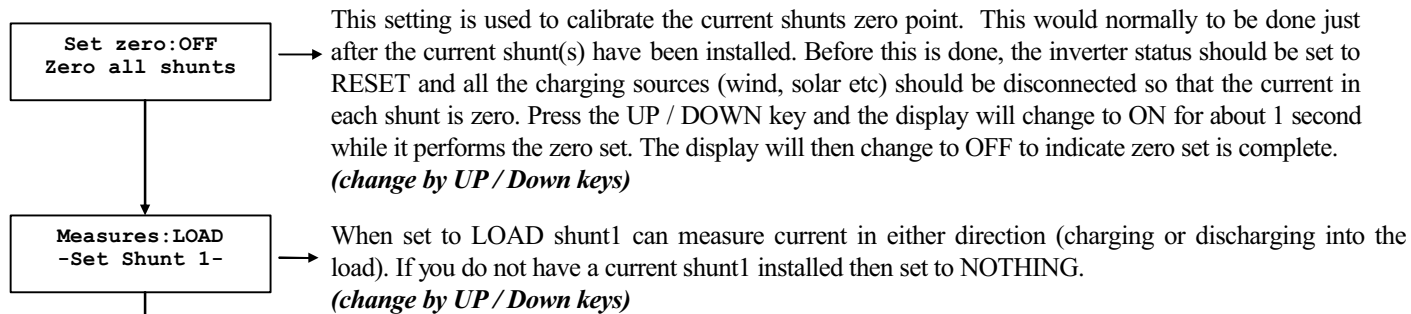

Continued next page

Shunt Settings Continued:

from previous page

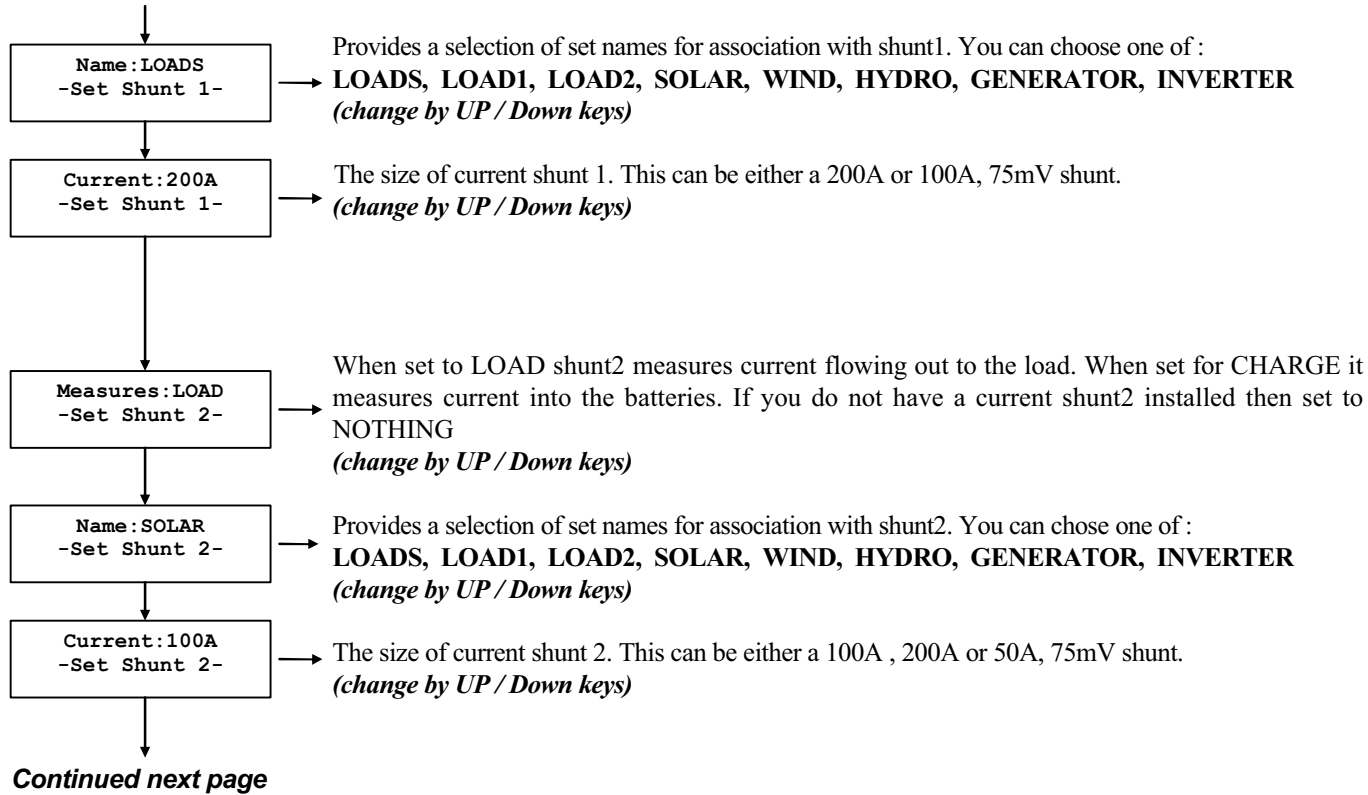

Shunt Settings Continued:

from previous page

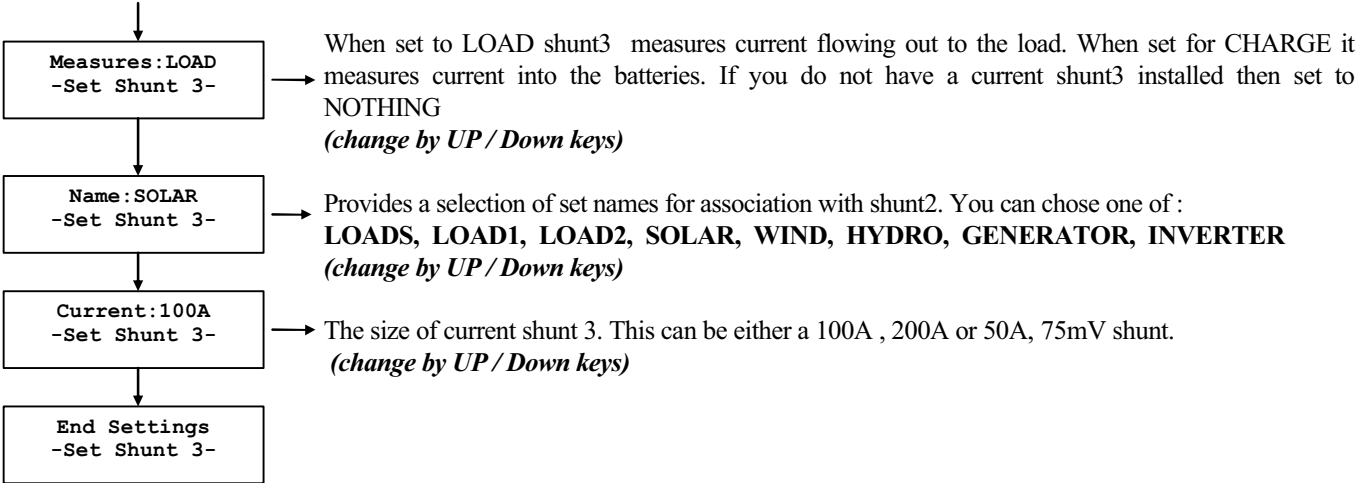

BATTERY SETTINGS

Hold down the DISPLAY key for several seconds while in a Status screen

You will see one of the following displays:

Note the Set:OUTPUT 1 display is the default, but whichever setting was last changed will be displayed.

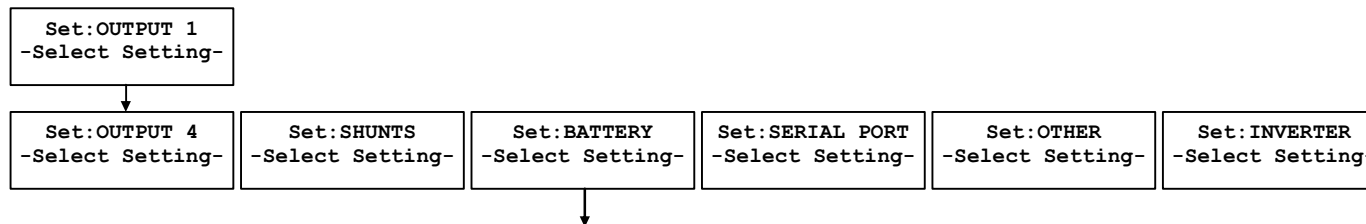

By pressing the Up or Down keys will move across the menus

By pressing the Display key you will move down the menus

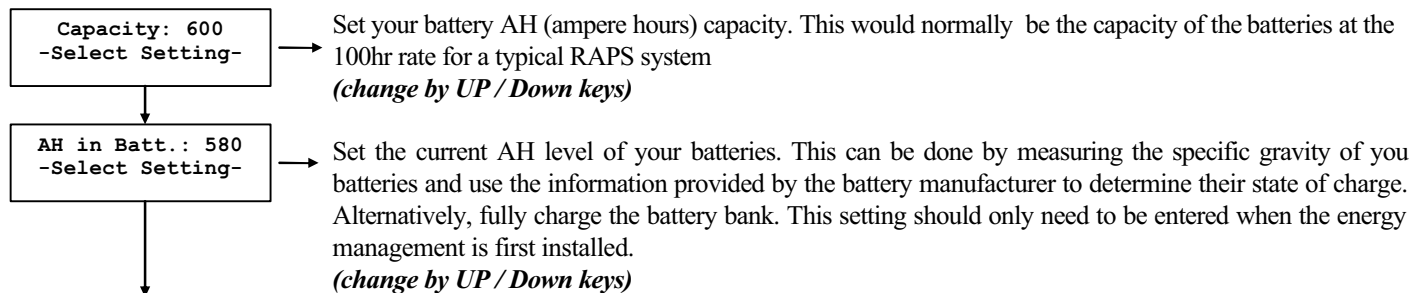

Continued next page

Battery Settings Continued:

from previous page

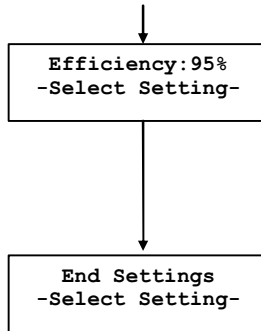

Set your battery efficiency figure. This would normally be 94 – 98% for new batteries, or 80 – 90% for older batteries depending on their age. If you are unsure, then set to 95%. This setting will be automatically updated if the regulator option is used. If the regulator option is not used, then you will need to trim this manually. This can be done as follows. If after a few weeks the % charge in the battery reads lower than it should, increase the battery efficiency. If it reads higher than it should then decrease the battery efficiency. Also the AH in Batt setting will need to be changed to bring it back in line.
(change by UP / Down keys)

SERIAL PORT SETTINGS

Hold down the DISPLAY key for several seconds while in a Status screen

You will see one of the following displays:

Note the Set:OUTPUT 1 display is the default, but whichever setting was last changed will be displayed.

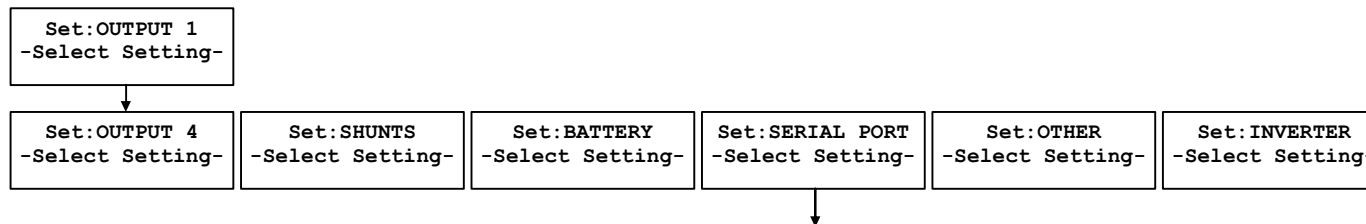

By pressing the Up or Down keys will move across the menus

By pressing the Display key you will move down the menus

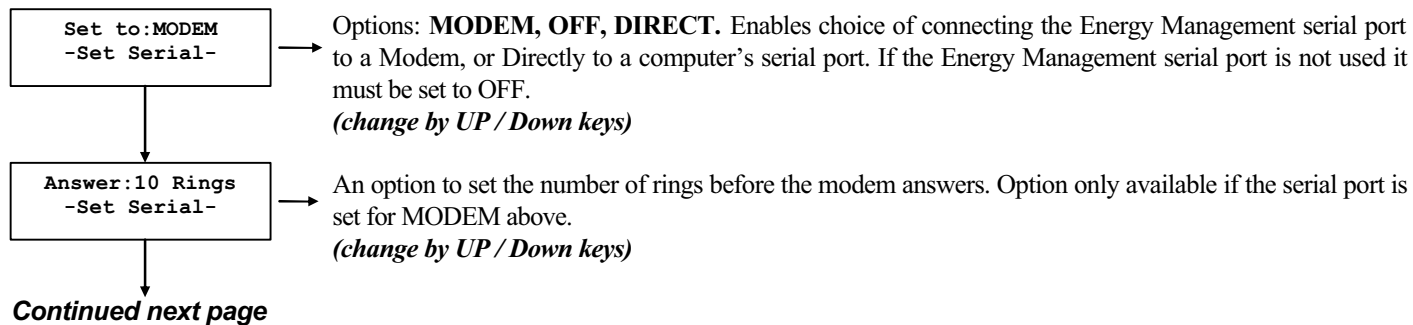

Serial Port Settings Continued:

from previous page

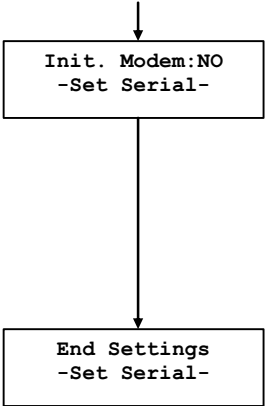

If set to YES, and the DISPLAY key is pressed, the Energy Management sends out a Modem initialisation string to set up the modem for auto answer and defaults. This will also occur when the Inverter powers up.

Again the option is only available if the serial port is set for MODEM.
(change by UP / Down keys)

Note: The connecting cable from the serial port to the modem is a standard “straight through” cable. If you are connecting directly to a computer you will need a “cross over” cable. A null modem cable is fine.

OTHER SETTINGS

Hold down the DISPLAY key for several seconds while in a Status screen

You will see one of the following displays:

Note the Set:OUTPUT 1 display is the default, but whichever setting was last changed will be displayed.

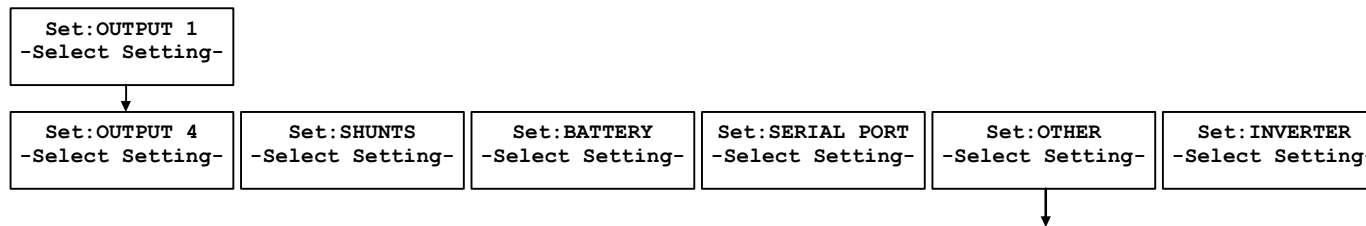

By pressing the Up or Down keys will move across the menus

By pressing the Display key you will move down the menus

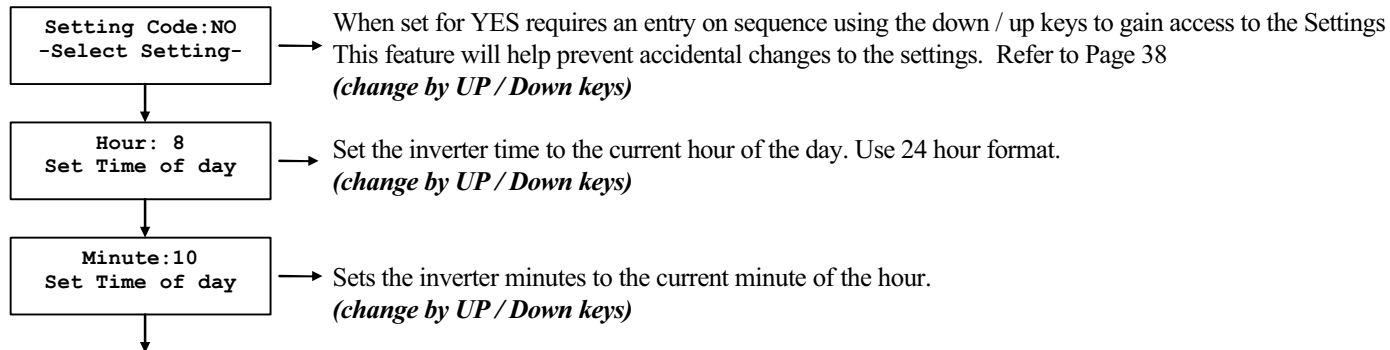

Continued next page

Other Settings Continued:

from previous page

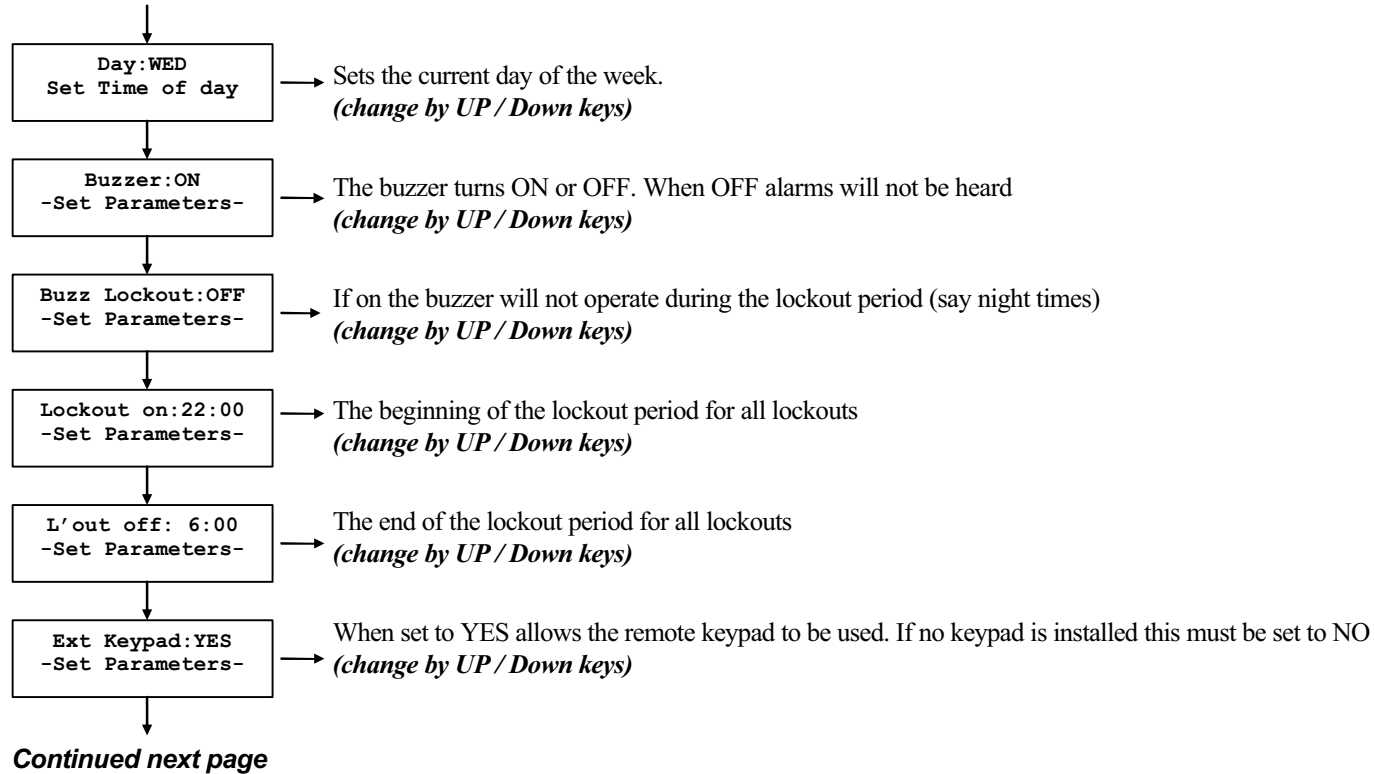

Other Settings Continued:

from previous page

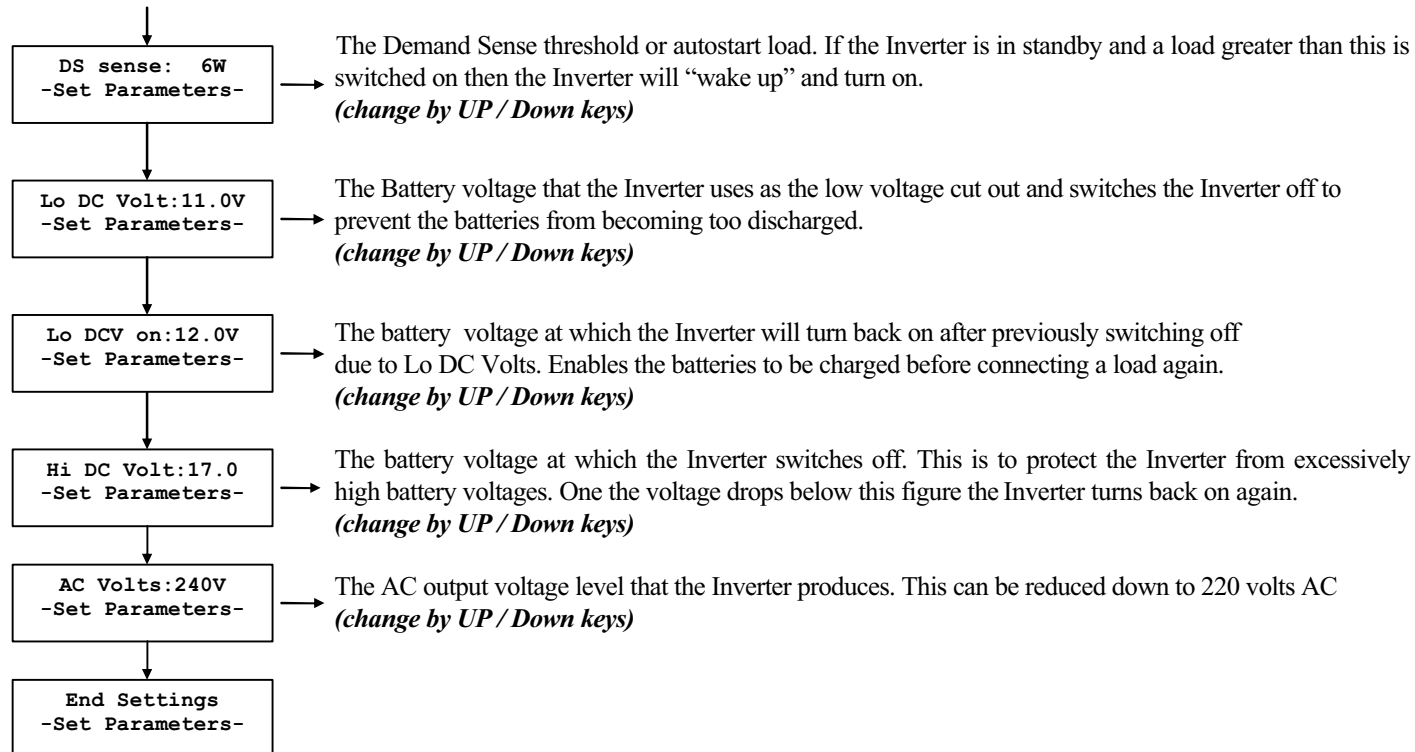

INVERTER SETTINGS

Hold down the DISPLAY key for several seconds while in a Status screen

You will see one of the following displays:

Note the Set:OUTPUT 1 display is the default, but whichever setting was last changed will be displayed.

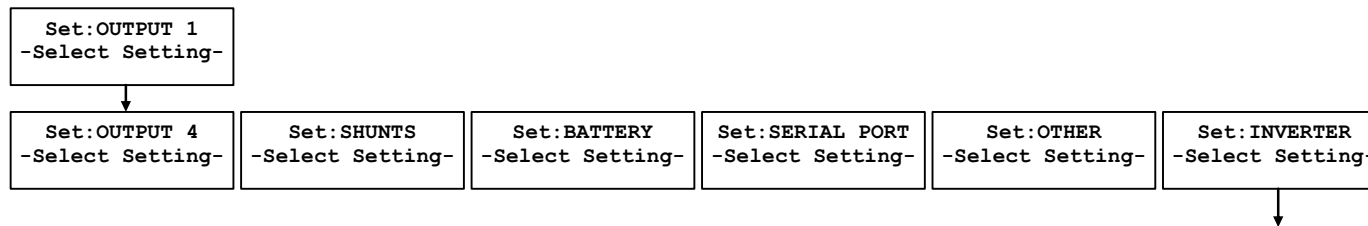

By pressing the Up or Down keys will move across the menus

By pressing the Display key you will move down the menus

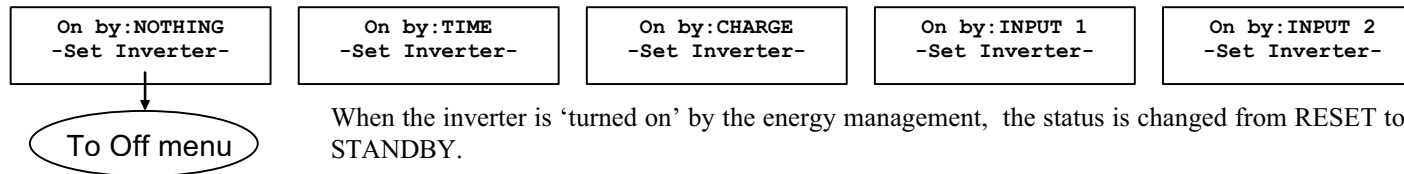

When the inverter is 'turned on' by the energy management, the status is changed from RESET to STANDBY.

Explanation:

On by:NOTHING	The inverter will not turn on automatically. The initial setting.
On by:TIME	The inverter will come on at a set time and day of the week
On by:CHARGE	The inverter will come on when the batteries are at a set charge level
On by:INPUT 1	The inverter will switch on when the voltage level at Input 1 is reached
On by:INPUT 2	The inverter will switch on when the voltage level at Input 2 is reached

Using this setting enables you to turn on the inverter on at a specific time and day of the week.

Note: The inverter is running in low power mode all the time. This control turns the AC output on.

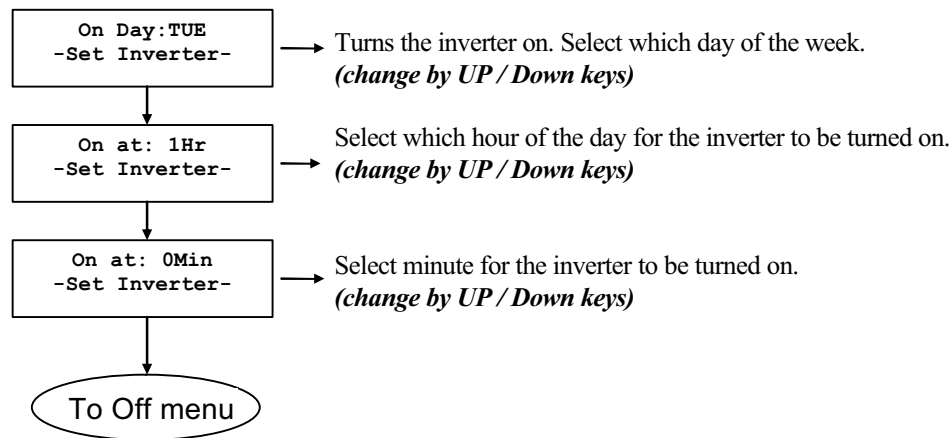
On by:Time

On by:CHARGE

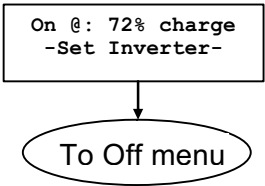

Turns the inverter on at a particular charge level in the batteries. Same as the output control.
(change by UP / Down keys)

Using this setting enables you to turn on the inverter at a specific time and day of the week.
Note: The inverter is running in low power mode all the time. This control turns the AC output on.

On by:INPUT Input 1 or Input 2

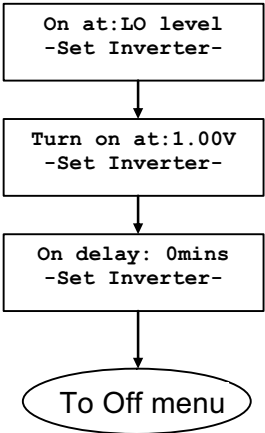

Turns the inverter on when the Input 1 or 2 voltage is either above or below the next setting
(change by UP / Down keys)

The Input voltage setting for turning the inverter on.
(change by UP / Down keys)

The minimum time the voltage should be at that level before turning the inverter on. Prevents false triggering
(change by UP / Down keys)

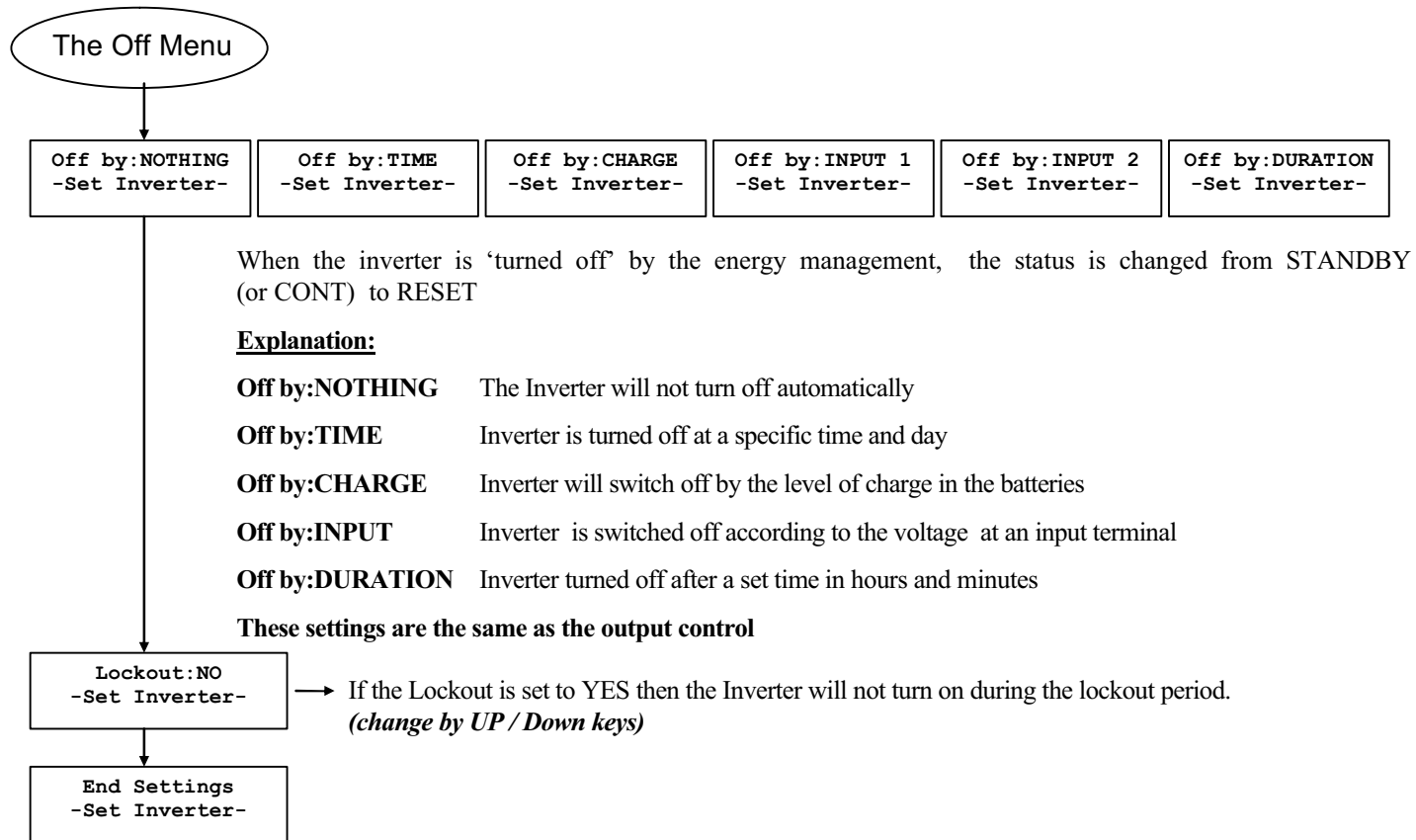

READINGS

With the Energy Management Mk II board installed a number of extra readings are available.

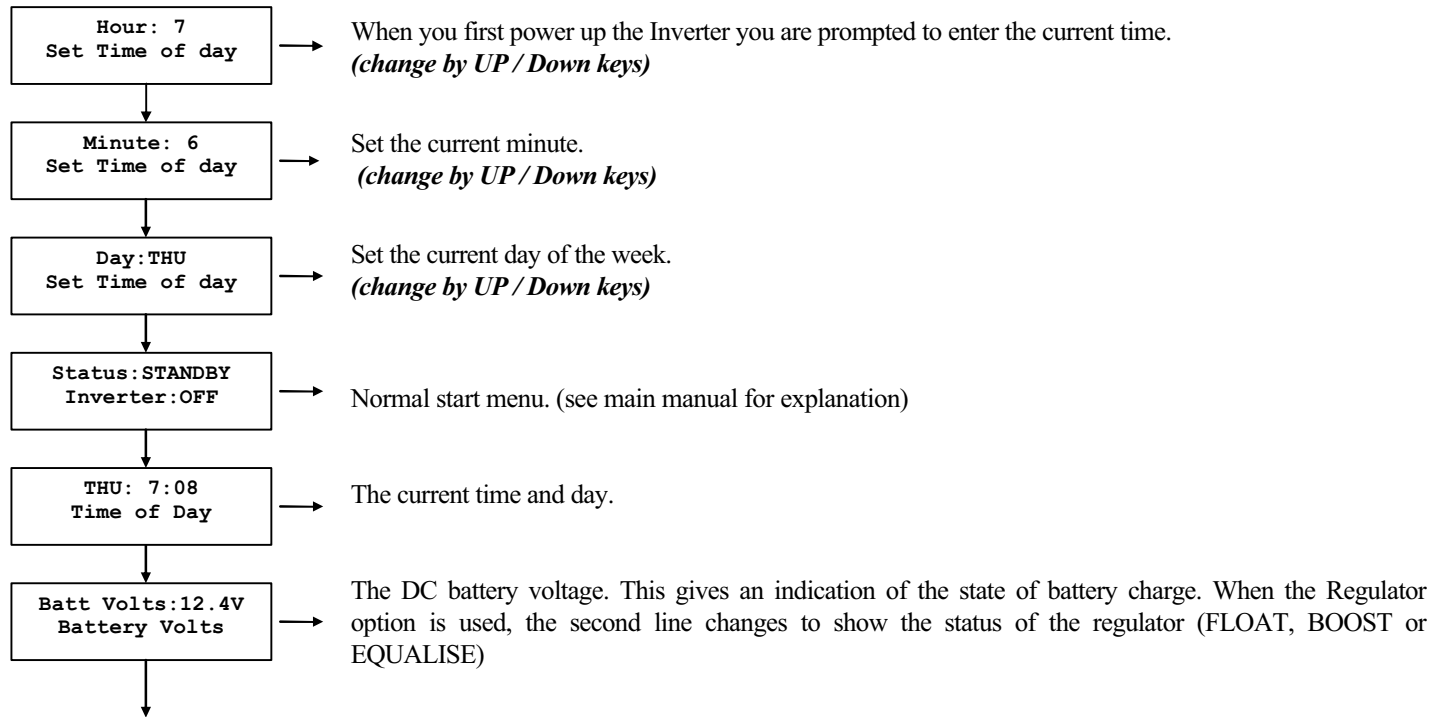

Continued next page
Readings Continued:
from previous page

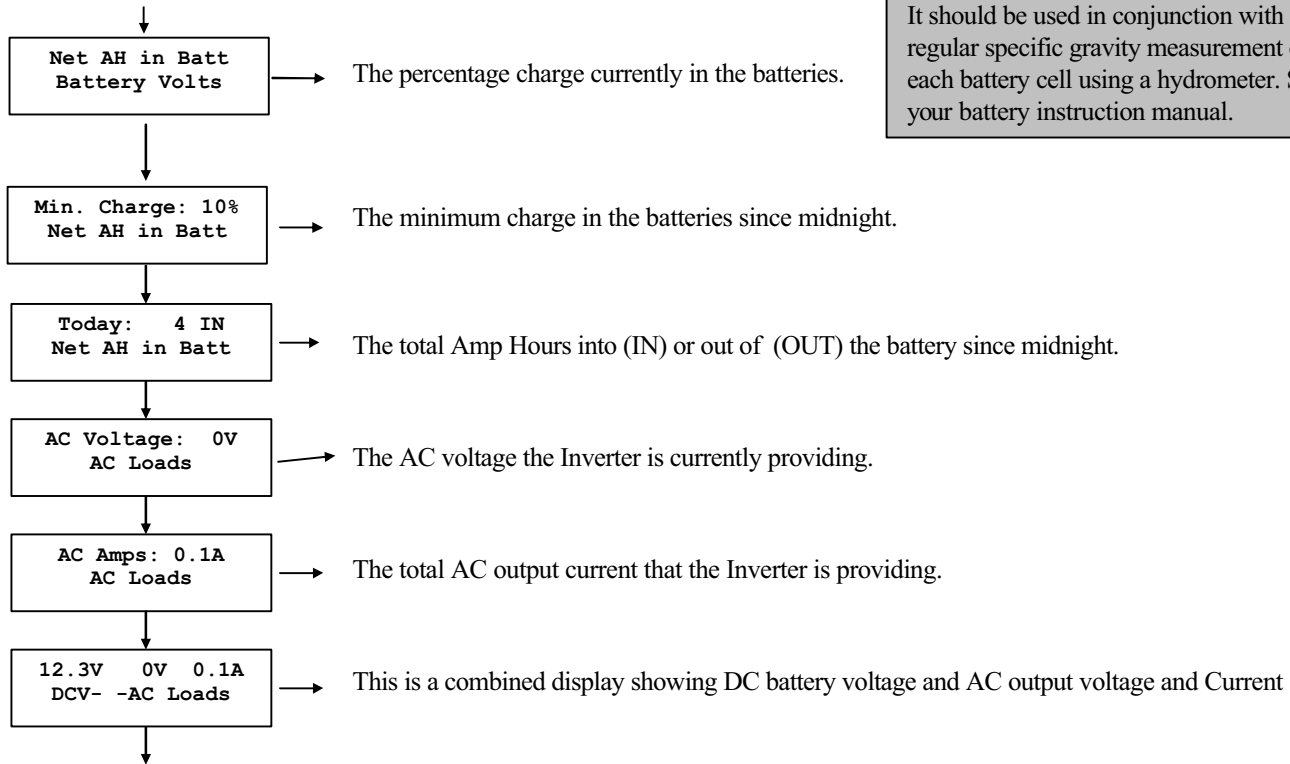

Use this reading as a guide only as an error may accumulate. It should be used in conjunction with a regular specific gravity measurement of each battery cell using a hydrometer. See your battery instruction manual.

Continued next page
Readings Continued:
from previous page

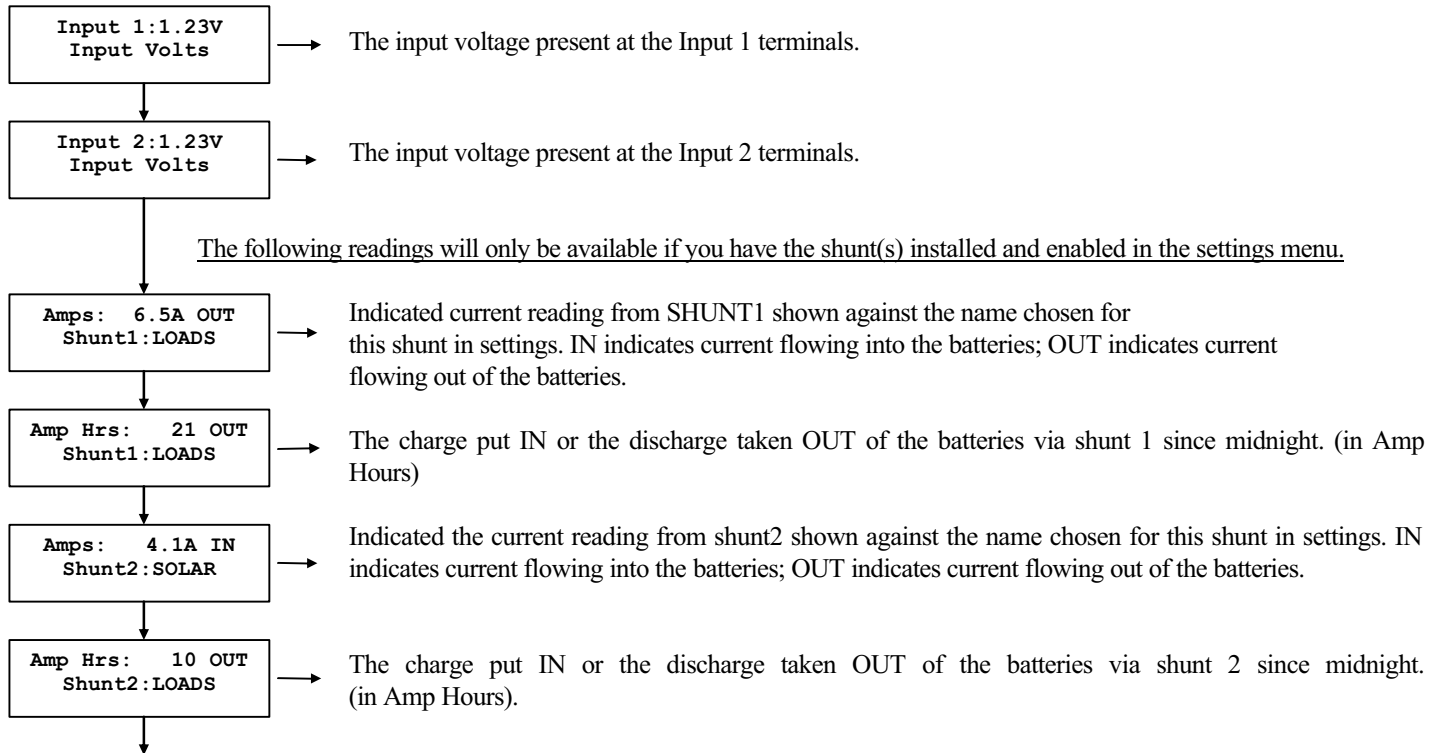

Continued next page

Readings Continued:

from previous page

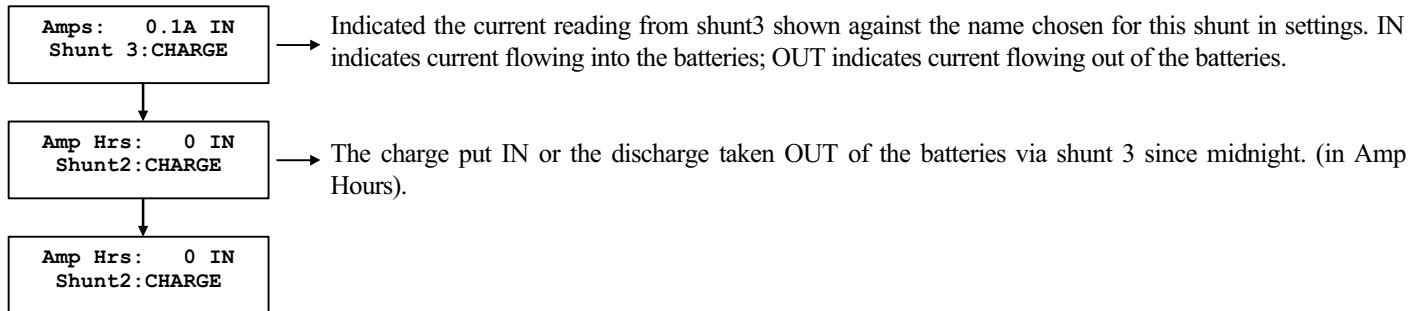

This section describes additional “Readings” available when OUPUT 1 has been configured for ‘GENERATOR’ (See pg 9 of the manual) and will be displayed after ‘Input Volts’ (Input 1 and Input 2) Readings (see pg 29 of manual)

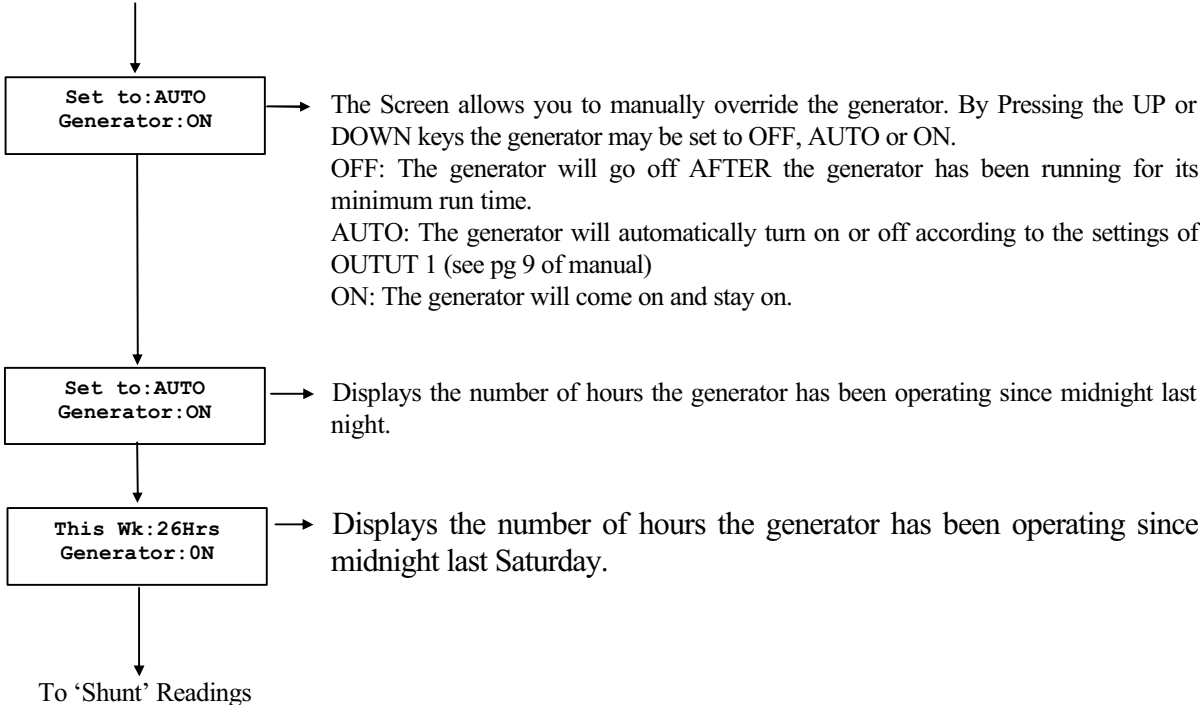

ADDITIONAL ELECTRICAL SPECIFICATIONS & INSTALLATION GUIDE

COMMUNICATIONS

RS232 connection via a DB9 connector on the rear of the Inverter. The Inverter used standard RS232 drivers, with no handshaking.

Direct Connection: This is by a “cross over” cable to a standard serial port on a Personal Computer. A Null Modem cable is suitable.
Connection speed is 4800 baud, 8 bits, no parity and one stop bit.

Modem Connection: A “straight through” cable is used for connection to a modem. The connection speed is 4800 baud.
The Inverter will send out a modem initialisation string to correctly set up the modem and set the number of rings chosen before answer.
When the modem is in operation the Keypad and Inverter front panel is disabled and indicates “Modem Connected - Please Wait”

Modem Supply: The Inverter will supply 8 volts DC for powering your modem. You will need to cut off the power pack and terminate the leads into the back of the Inverter as shown in the appendix.

KEYPAD

The optional keypad can also be installed via a rear connector; wiring details in the appendix. The keypad layout is slightly different for the Energy Management Mark II to that used on previous Selectronic Inverters. When the modem is in operation the keypad is disabled.

INPUT LINES

Two analogue input lines are provided via the rear connector.

The input voltage ranges: For Analogue measurement = 0 to 2.5V DC. If the input voltage exceeds 2.5V then the inverter will still show this as 2.5V.

For Off / On switching = 3 to 30V DC

These inputs can be treated as straight On / Off inputs or a specific voltage level programmed between 0 - 2.5V DC. When the input reaches this level then the Inverter will respond as programmed in the Settings menus.

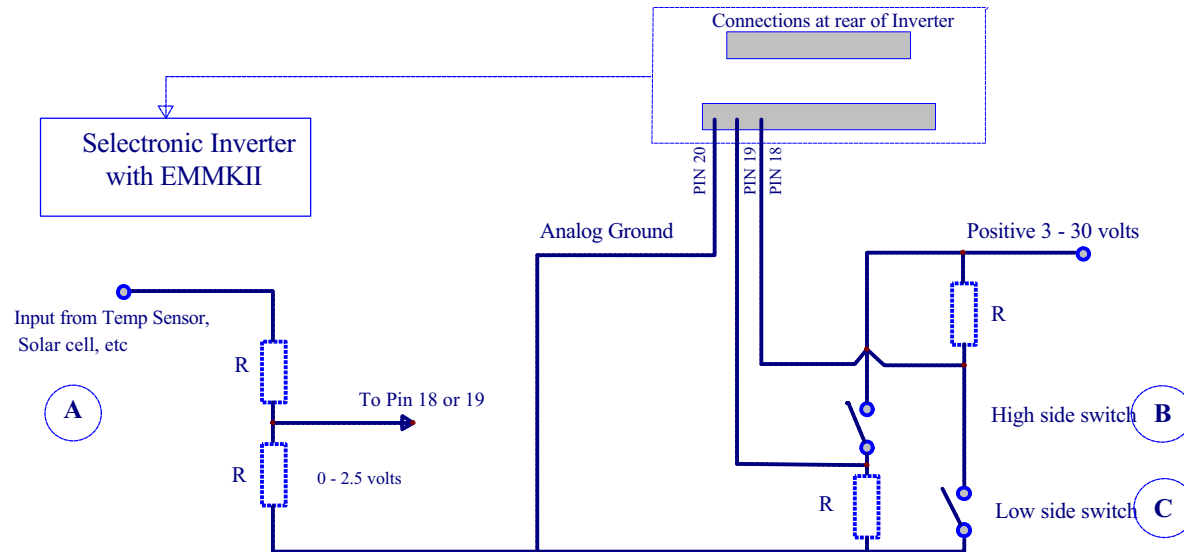

Inputs: The diagram above illustrates how the inputs can be used

- A This shows the input measuring a varying input from say a small solar cell. The two resistors R will need to be chosen to provide the correct scaling. Example. If the cell outputs 0-5 volts then the resistors would need to be equal values to half the level. Two 10,000 ohm say.
- B Shows a switch wired into the positive side of the supply. Resistor R is used to limit the current when the switch is closed. 10,000 ohm say.
- C Shows the arrangement if you have the switch connected to the ground side. Resistor R as for the high side arrangement.

OUTPUTS

Four outputs are provided. These are open collector transistors which can sink 100mA each. The maximum voltage on each output is 60 volts DC. Connection details and some additional information is in the appendix.

Outputs: The outputs are open collector transistors which can sink 100mA each. This can be used to operate a contactor which has 240V AC contacts to switch on a generator, pump etc. Alternatively the output could operate relays which drive solenoids, lamps etc.

Note if driving a contactor direct from an Output, ensure the contactor coil does not draw more than 25mA. If it does, a small relay should be used instead, with the relay contacts controlling the contactor coil.

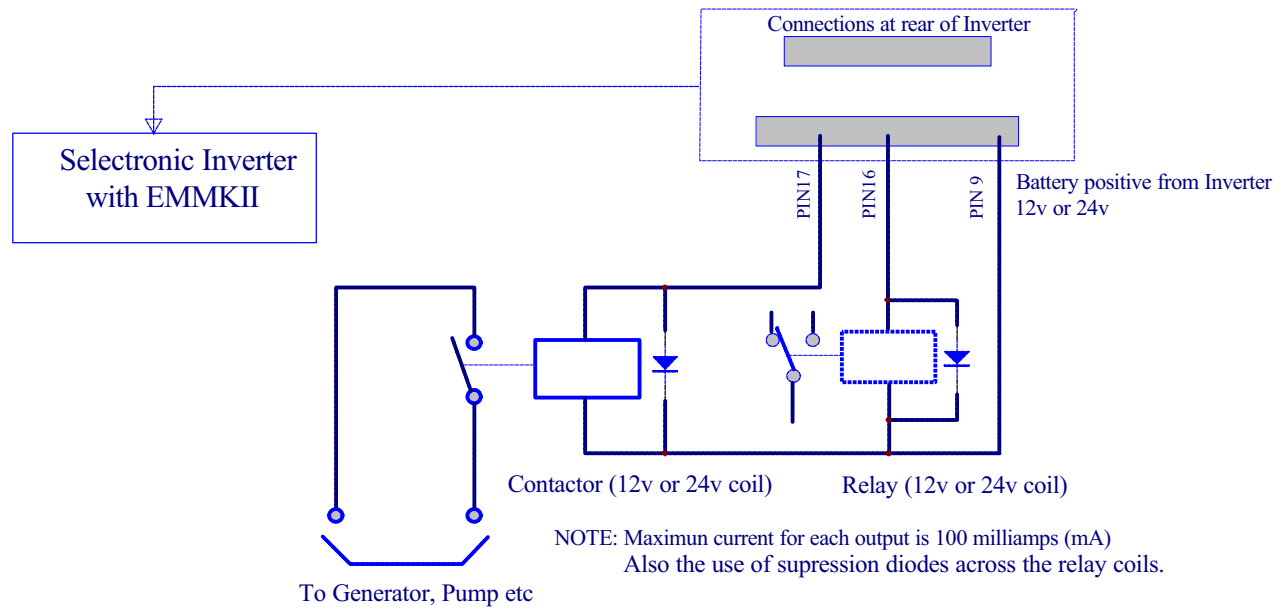

CURRENT SHUNTS

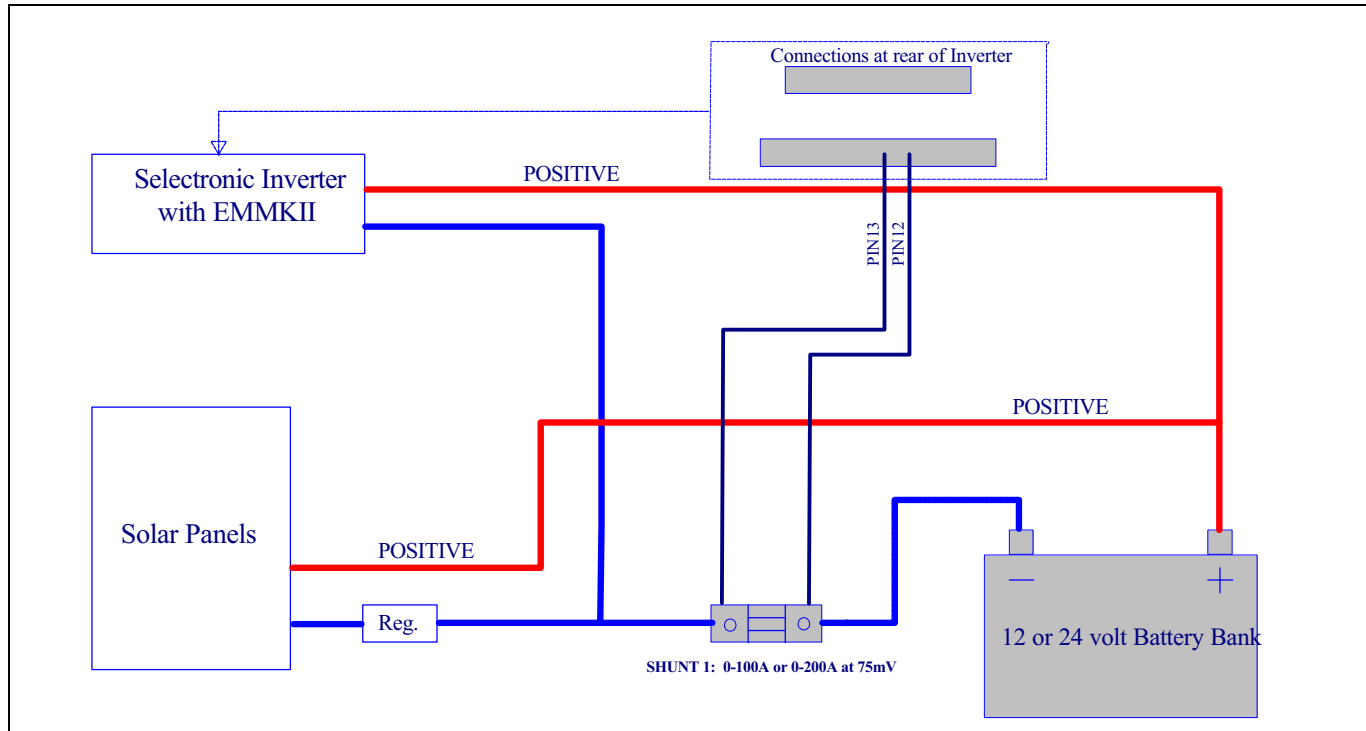

SINGLE SHUNT MEASUREMENT

The diagram above illustrates the connection arrangement for a system using one shunt and a charging source such as a Solar Array. The shunt is set up for SHUNT1 in the settings. As shunt 1 is able to measure current in both directions you will be able to see if the net current flow is charging or discharging your batteries at any time.

In the discharge direction the shunt will measure 0-200Amps or 0-400Amps surge current using a 0-200A, 75mV shunt

In the charge direction 0-100Amps using the same shunt. Charging currents in excess of 100Amps will still show as only 100Amps.

When a 100A 75mV shunt is used, the current ranges are halved.

MULTIPLE SHUNT MEASURING

In multiple shunt arrangements SHUNT1 can be used to still measure overall Net charge or discharge into your batteries as shown.

SHUNT2 and SHUNT3 can then be used to measure the contribution by your Solar Panels and Generator.

This is just an example. You may only have a single charging source so you would not need SHUNT3.

Another application may be where you have other DC loads connected to your batteries, perhaps a DC refrigerator and you wish to measure this current separately. The third shunt could be used for this. Note if you were measuring discharge with SHUNT3 you would need to swap the measuring wires going to Pins 8 and 9 at the rear connector as shunts 2 and 3 only measure in one direction.

IMPORTANT NOTES:

- 1.** All shunt measuring wires which go to the rear connectors on the back of the Inverter should go only to the small screws on the each side of the shunt.
- 2.** All heavy current leads must be terminated at the large bolts on the shunts. Do not use the small screws.
- 3.** All shunts must be connected in the NEGATIVE side of the circuits as shown.

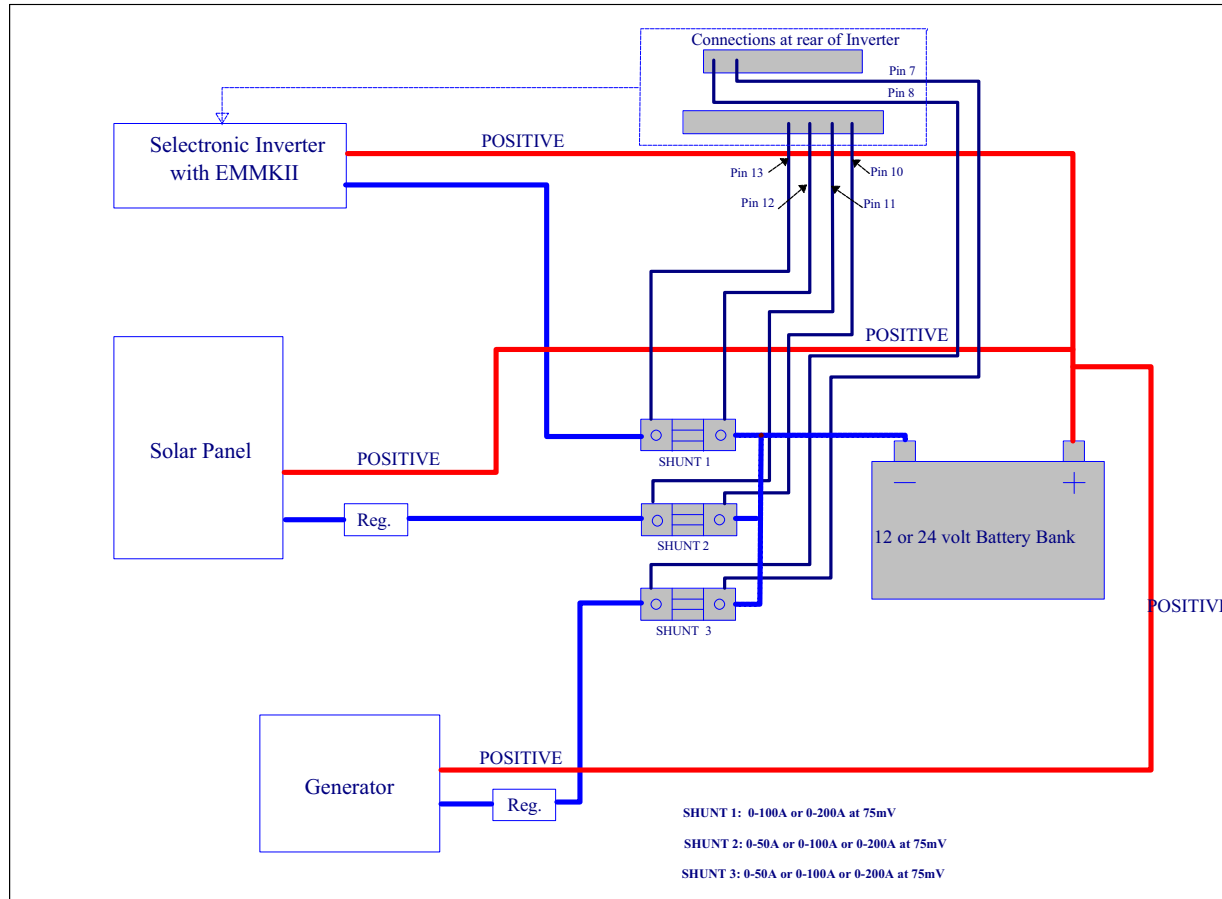

SECURITY LOCKOUT (Setting Code)

When Setting Code is set to YES in the settings menu this provides access to only the Readings displays. Users are unable to alter the settings without first entering the security code. The code is entered by a sequence on the Up, Down keys on the front of the Inverter. The sequence is (Down, Up, Down, Down)

Through a policy of continued development, specifications are subject to change without notice.

Electrical specifications

Parameter	Energy Management MKII
Sink current on Outputs 1 – 4 (Relay coil current)	100mA maximum
Voltage on Outputs 1 – 4 (Relay coil voltage)	65V maximum
Operating voltage range on inputs 1 and 2	0-2.5VDC
Maximum voltage on inputs 1 and 2 without damage	+/- 30V
Modem communication interface	RS232 via DB9 connector
Current capability of the 8V power supply for the modem	0.4A maximum
Keypad communication interface	RS422
Keypad power supply	Via 8V modem supply
Shunt 1 input voltage	-47.5mV to +150mV
Shunt 2 and 3 input voltage	0 to 75mV

Control functions and settings

Parameter	Range	Steps/resolution
¹ Delay settings for inputs 1 and 2 when programmed to control outputs 1 – 4 or inverter on/off.	0 – 40 minutes	1 minute
¹ Delay settings for battery voltage when programmed to control outputs 1 – 4 or inverter on/off.	0 – 40 minutes	1 minute
¹ State of charge in batteries setting when programmed to control outputs 1 – 4 or inverter on/off.	0 – 101%	1%
² Regulator boost, float & equalize voltage setting		
with 12V battery	13.0 - 16.8 V	0.1V
with 24V battery	26.0 - 33.6 V	0.1V
with 48V battery	52.0 - 67.2V	0.1V
Generator change over delay setting	0 – 250 sec	10 sec
Minimum generator run time setting	0 – 40 minutes	1 minute
Lockout start time setting	0:00 to 23:00	1:00 (1hr)
Lockout end time setting	0:00 to 23:00	1:00 (1hr)
¹ “Time of day” time settings when programmed to control outputs 1 – 4 or inverter on/off.	0:00 to 23:00	0:01 (1 minute)
¹ “Time of day” day settings when programmed to control outputs 1 – 4 or inverter on/off.	Sun to Sat and ALL (every day)	

Parameter		Range	Steps/resolution
³ Current readings on shunt 1	With 200A	-100A to 200A (400A surge)	0.2A
	With 100A shunt	-50A to 100A (200A surge)	0.1A
³ Current readings on shunt 2 and 3	With 200A	0 to 200A	0.2A
	With 100A shunt	0 to 100A	0.1A
	With 50A shunt	0 to 50A	0.1A

Notes:

1. These can be programmed separately for each of the four outputs and the inverter control
2. Each output may be programmed to a different boost and float voltage.
3. All current shunts are 75mV.

REAR PANEL CONNECTIONS

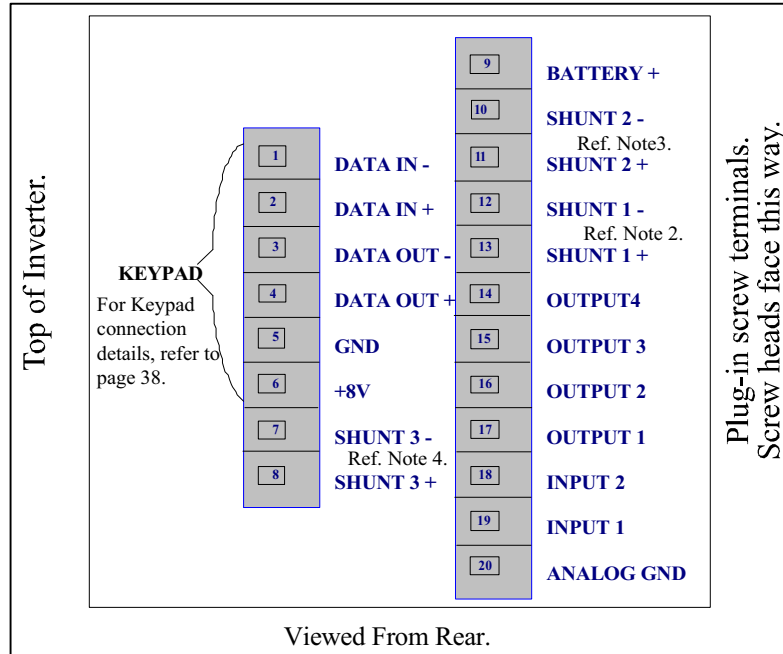

Note 1: All shunt measuring wires which go to the rear connectors on the back of the Inverter should go only to the small screws on each side of the shunt.

Nothing else should go to these connections.

Note 2: Shunt 1. Always Connect Shunt 1- (12) to battery negative side of shunt.

Note 3: Shunt 2. Connect Shunt 2+ (11) to battery negative side of shunt for charging, Connect Shunt 2- (10) to battery negative side of shunt for discharging.

Note 4: Shunt 3. Connect Shunt 3+ (8) to battery negative side of shunt for charging, Connect Shunt 3- (7) to battery negative side of shunt for discharging.

Rear Panel Connections Continued:

The full range of features are:

- a) Remote Keypad: A low profile keypad with 2-line Liquid Crystal Display, which can be located up to 500 metres from your inverter.
Wiring requirements - 6 conductor shielded cable.
- b) DC Current Shunt: Consists of a 200 Amp 75mV current shunt, mounted on an insulated base, and a twin flex loom for current sensing.
Alternative ranges are 50 Amp or 100 Amp, 75mV shunts.
- c) Controller Outputs: External relays or contactor coils can be energised for various AC or DC switching applications.
- d) Alarm / Control Inputs: Two inputs that can be programmed to monitor switch contact status or voltage levels. These inputs can operate as either digital Off / On inputs at 0V or 2.5V or they can act as analogue inputs reading the input voltage between 0 or 2.5v. If your input voltage level is greater than 2.5 volts then this will need to be scaled down by using a voltage divider. If you are unsure how to do this contact your supplier or installer.

INSTALLATION OF EMMKII OPTIONAL KEYPAD

Installation of the optional keypad requires a suitable length of 6 conductor (3 pair) shielded 7 / 0.2 data cable.

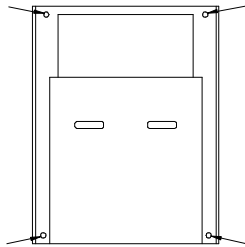

1. Carefully unpack the keypad mounting kit.
The front cover has been left loose to allow access to the four mounting holes shown by the arrows.

2. Prior to attaching the keypad to the wall, bulkhead, etc., complete the electrical connections to the user screw connector as shown in the diagram. Please take careful note of the orientation. Plug the screw connector into the back of the keypad and secure the keypad chassis in its intended location



3. The grey plastic front cover is attached by applying firm pressure over the front panel at the points shown opposite.

4. At the Inverter end of the shielded cable, connect the 6 wires to the screw terminals (1 to 6) on the plug that connects into the back of the Inverter, as shown in diagram following. Connect the cable shield to the 0V terminal (No. 5, Black) to reduce radiated electrical noise from the cable.

5. Ensure that the Inverter is switched off at the front panel circuit breaker.

6. Plug the 8 way plug into the socket in the rear of the Inverter.

Installation of EMMKII Optional Keypad Continued

Set:OTHER
-Select Setting-

Ext Keypad:NO
-Set Parameters-

7. Switch on the Inverter at the circuit breaker. The keypad will not display any information at this stage.
8. Via the Inverter front panel, access the “Settings” menu. Using the *UP* key keep pressing until this display is seen:

Then, using the *Display* key move down the menu until the following display appears:

Select YES using the Up key. Scroll through the remainder of the Settings displays until the Readings displays are reached.

9. The external keypad will now display the same information as appears on the Inverter front panel. The readings may be displayed on the keypad by continuing to press a Key. For example one press of the ‘AC reading’ key will display AC volts, a second press of the key will display AC current.

Installation of EMMKII Optional Keypad Continued

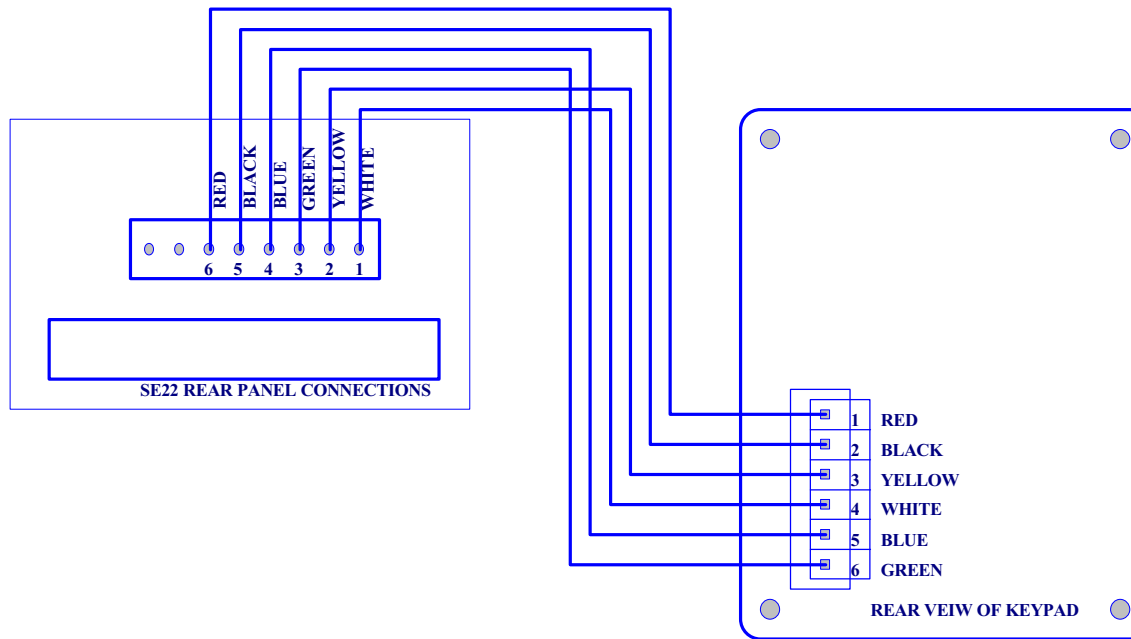

INSTALLATION OF OPTIONAL CURRENT SHUNTS

1. The 75mV precision current shunt(s) must be fitted, as shown in the diagram. Please ensure that cables are kept as short as possible. At least 120 Amp continuously rated battery cable should be used between battery and shunt(s).
2. Attach the shunt and insulated base securely to a solid structure.
3. Using the twin flex supplied, wire up the current sensing wires as shown in the diagram. Take careful note of the polarity.
4. Ensure that the Inverter Status is in "RESET" mode, which ensures that the Inverter is not drawing any DC current through the shunt. Also, disable all charging sources, such as Solar Panels and wind generators and turn off any DC loads.

5. Via the Inverter front panel or Keypad, access the "Settings" menu.

Keep pressing the *UP* key until the Shunts option is reached.

Now you can move down the menu using the *Display* key and set up your shunts.

```
Set: SHUNTS
-Select Setting-
```

6. Once the shunt(s) are installed re-enter the shunts settings and zero the shunts.

The first screen in Shunts Settings is:

Select ON using the "UP" key. Note: when this setting is set to ON, a "zero DC amps" is performed taking about 1 to 2 seconds, after which the display returns to OFF.

Scroll through the remainder of the "Settings" screens until the "Readings" screen is reached.

```
Set zero:OFF
-Zero all shunts-
```

7. Scroll through the "Readings" screen until this screen is displayed:

Note that when the battery current is zero, the screen may flicker between **IN** and **OUT**; this is quite normal.

```
Amps: 0.0A OUT
Shunt1: INVERTER
```

8. Apply an AC load to the inverter's output and verify that the DC current reading is "OUT".

If not, then reverse the sensing wires to the current shunt.

Repeat the above to check any other current shunts that have been installed.

WARNING**THE OUTPUT VOLTAGE FROM AN INVERTER IS AS LETHAL AS LANDLINE POWER.**

It is therefore absolutely necessary for your safety to ensure that all Remote Area power installations meet and comply with the relevant provisions and requirements of wiring standards.

It is imperative that you ensure that only Electrical contractors are permitted to install any AC wiring in your system.

PRODUCT WARRANTY**Warranty**

Selectronic Australia Pty Ltd warrants your inverter to be free from defects in materials and workmanship under normal use and service, for an initial period of five (5) years. Defective parts will be replaced or repaired free of charge within this period.

Conditions

This warranty is applicable only from the date of original purchase.

The provision of this warranty shall not apply if the unit has been subject to misuse, neglect, act of God, accidental damage or has been used for a purpose for which it is not intended. Unauthorised modification or repair will void your warranty. To ensure a smooth and speedy response to your warranty claim, please complete and return your reply paid warranty card within 30 days from date of purchase.

Within Australia & New Zealand

The inverter must be returned, at the owner's cost, to an authorised service centre listed in this manual. There will be no charge for the return of the inverter.

Outside Australia & New Zealand

Product purchased for use outside Australia & New Zealand must be returned to Selectronic Australia's Service Centre to enable warranty claims to be processed. Freight cost to be borne by the customer. No charge will be made for the product return.

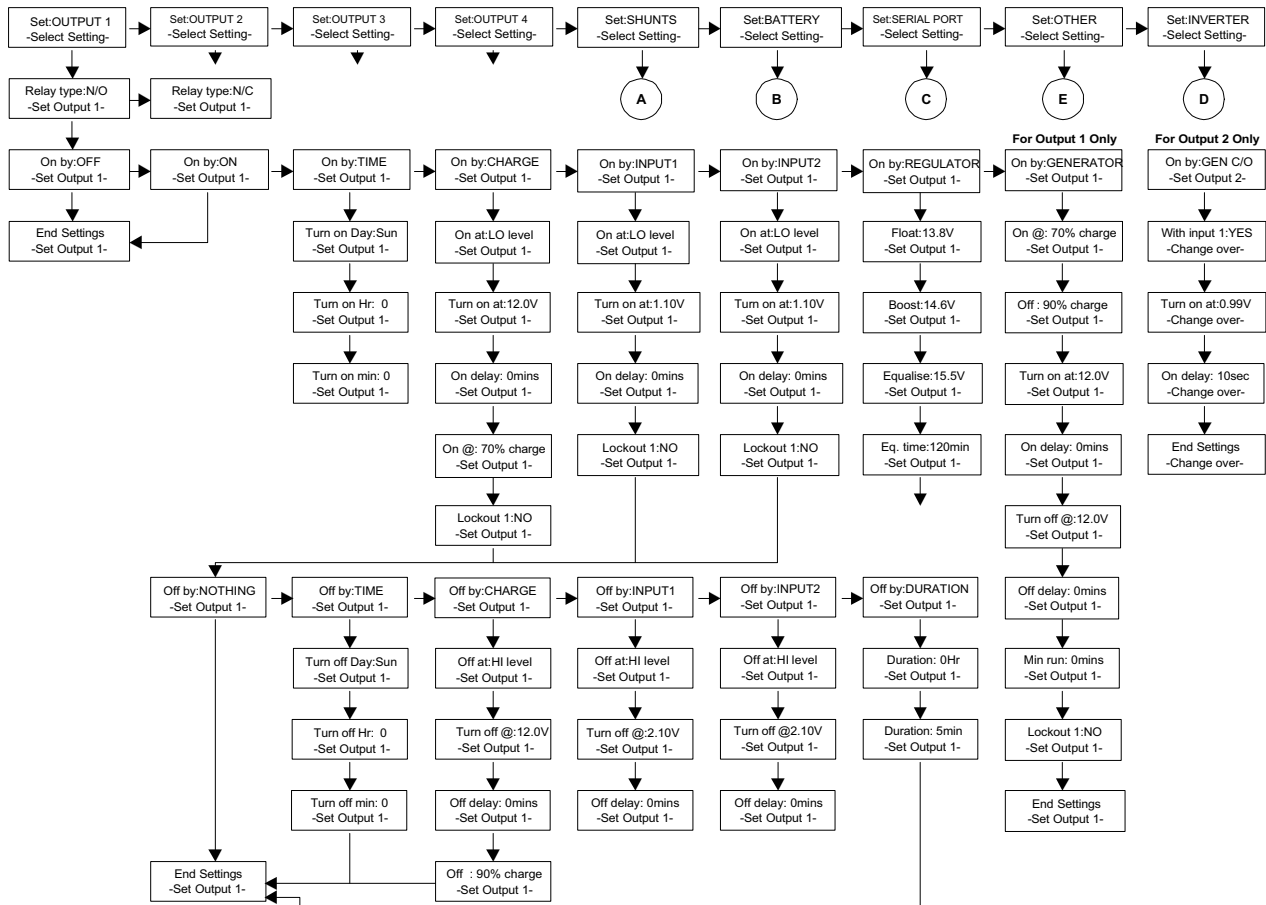

50

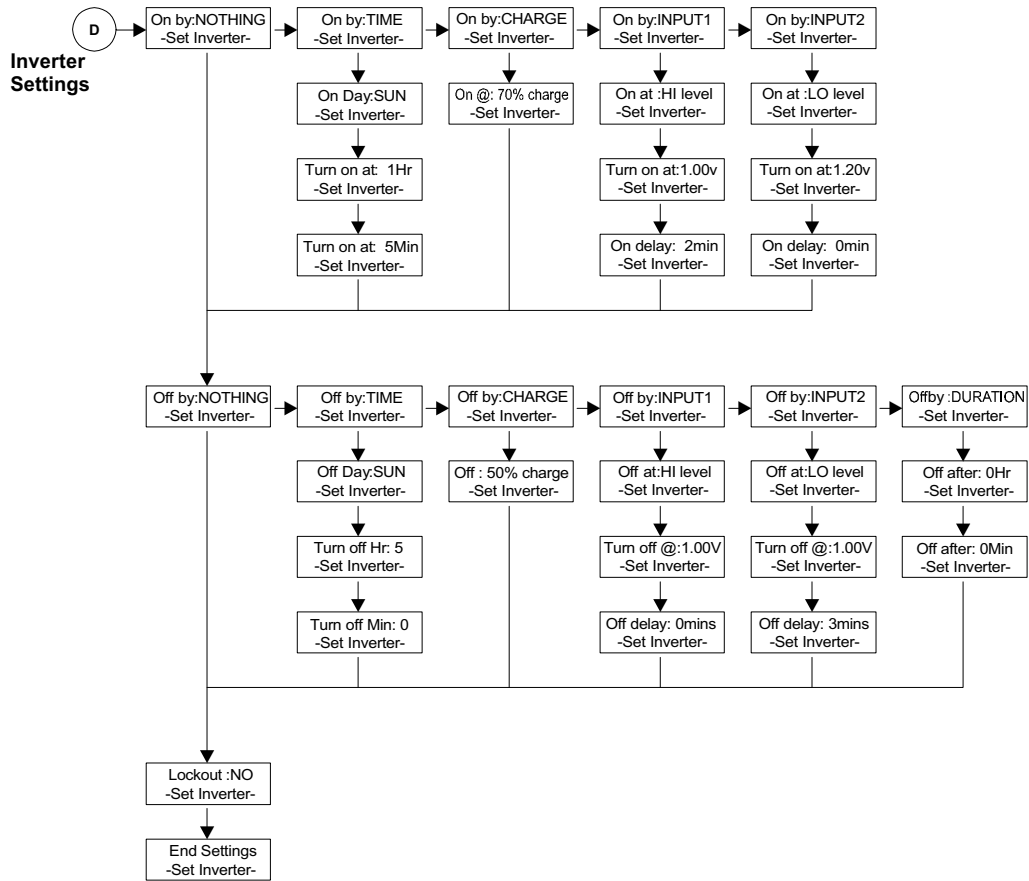

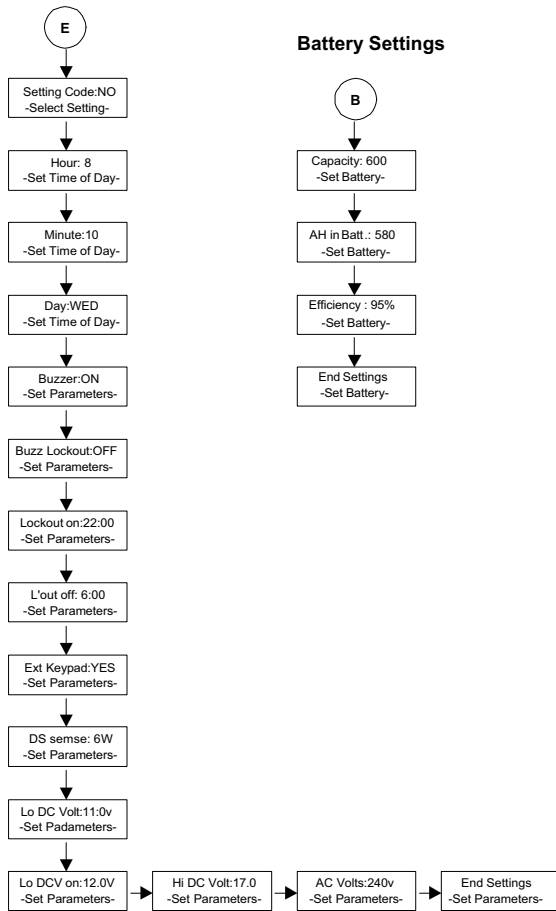

Battery Settings

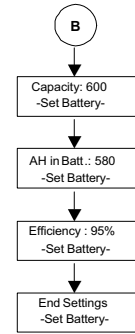

Serial Settings

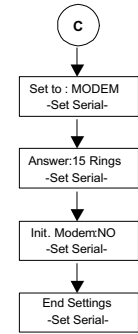

Shunt Settings

