

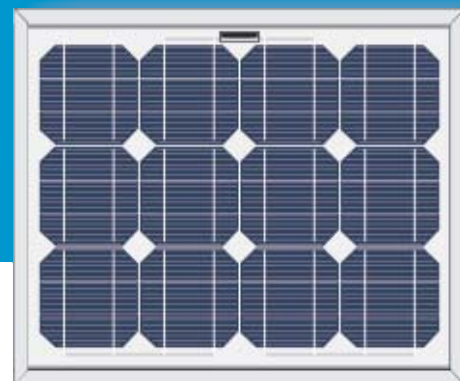





TO POWER OUR FUTURE

# STP040S-12/Rb

## Monocrystalline Silicon Solar Module



-  Suntech Power Modules are internationally regarded as a quality symbol from a well valued brand
-  Suntech Power Modules are the difference on customers' roofs  
Only Suntech Power Modules combine more power per square-meter with more energy per Watt-peak  
Thus, Suntech Power Modules overbid your investment
-  Suntech Power Solar Cells Features
  - Top solar cell conversion efficiency
  - Entrapping light through advanced textured solar cells in monocrystalline technology
  - SiN-film deposition on the front surface for uniform dark appearance
  - Outstanding energy output in low light conditions through high shunt resistance
  - Densely screen-printed grid
-  Suntech Power Solar Modules Features
  - 36 high-efficiency Suntech Power Silicon Solar Cells
  - More power in peak hours through Suntech Power Cells
  - Optimized module performance with Nominal Voltage 12 V DC
  - Bypass diodes to avoid hot-spot effect
  - Cells are embedded in a sheet of TPT and EVA
  - 3.2 mm high transmissive low-iron, tempered glass
  - Unique esthetic appearance of cells
  - Attractive, stable, heavy duty anodized aluminum frames with convenient mounting-access, for high wind-pressure and snow-load
  - The backside frames are equipped with drainage holes. So we eliminate the risk that rain or snow water may accumulate in the frame lumen and freeze or even bend the frame in cold season
  - Pre-cabled with fast-connecting systems
  - Customer-desired packing
  - 25 years Limited Power Warranty
  - Certifications: IEC 61215, TÜV class II, CE, ISO 9001:2000
-  Suntech Power Module Applications
  - Designed for grid-connected power plants up to 1000V DC
  - Ideal also for use in large stand-alone systems for battery charging or water pumping

## Specifications

Cell	Monocrystalline silicon solar cells 156mm×52mm
No. of cells and connections	36 (4×9)
Dimension of module(mm)	537×665×30
Weight	4.5 kg

## Characteristics

Model	STP040S-12/Rb
Open circuit voltage (Voc)	21.6V
Optimum operating voltage(Vpm)	17.2V
Short circuit current(Isc)	2.62A
Optimum operating current(Ipm)	2.32A
Maximum power at STC(Pm)	40Wp

STC: Irradiance 1000W/m<sup>2</sup>, Module temperature 25°C, AM=1.5

## Certifications

IEC61215	TÜV class II
ISO9001:2000	CE

## Characteristics

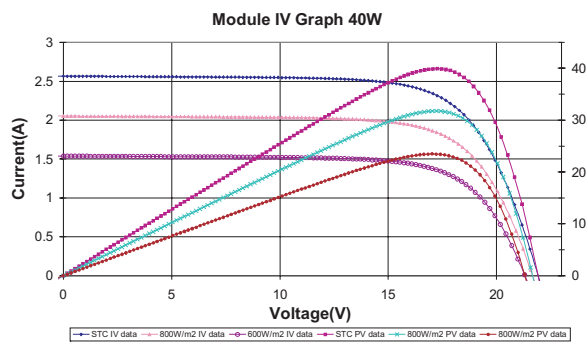

## Limits

Operating temperature	-40 to +85°C
Maximum system voltage	1000 V DC

## Temperature and Coefficients

NOCT	48°C ± 2°C	
Current temperature coefficient	%/K	0.06 ± 0.01
Voltage temperature coefficient	mV/K	-(155 ± 10)
Power temperature coefficient	%/K	-(0.5 ± 0.05)

NOCT: Nominal Operation Cell Temperature

## Output

Type of output terminal	Junction box
Cable	LAPP(4.0mm <sup>2</sup> )
asymmetrical lengths	mm(-) and mm(+)
Connection	Suntech Plug Type IV

## Blueprint of the module

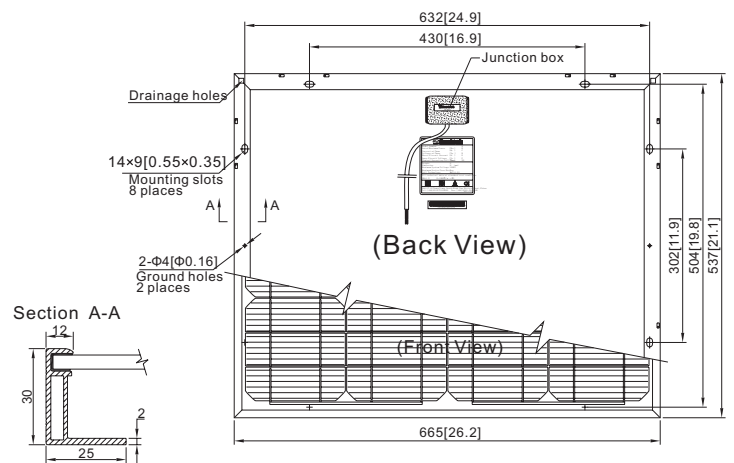

Note:mm[inch]

**Suntech**

www.suntech-power.com E-Mail:sales@suntech-power.com  
17-6 Chang Jiang South Road, New District Wuxi, China 214028  
phone: +86-510-5345000 fax: +86-510-5343049



©Suntech 2005